

NOTE:

This brochure contains IMPORTANT safety info. Please read and keep for future reference.

MAINTAINANCE AND WARNING

- Keep furniture away from heat sources.
- Do not clean furniture with harsh cleaner or polishes. Do not use detergents, Solvents, abrasives, spray packs or leather cleaner. Use non-color mild soap with warm water to clean spills (Mix 1:10 soap to water)
- Do not place furniture under direct sunlight, material will possibly fade over time.
- Do not use on site dry Cleaning machine. Children should not climb or jump on the furniture.
- Do not write on furniture that is not protected by a padded barrier .
- Not for commercial use, only for residential use.







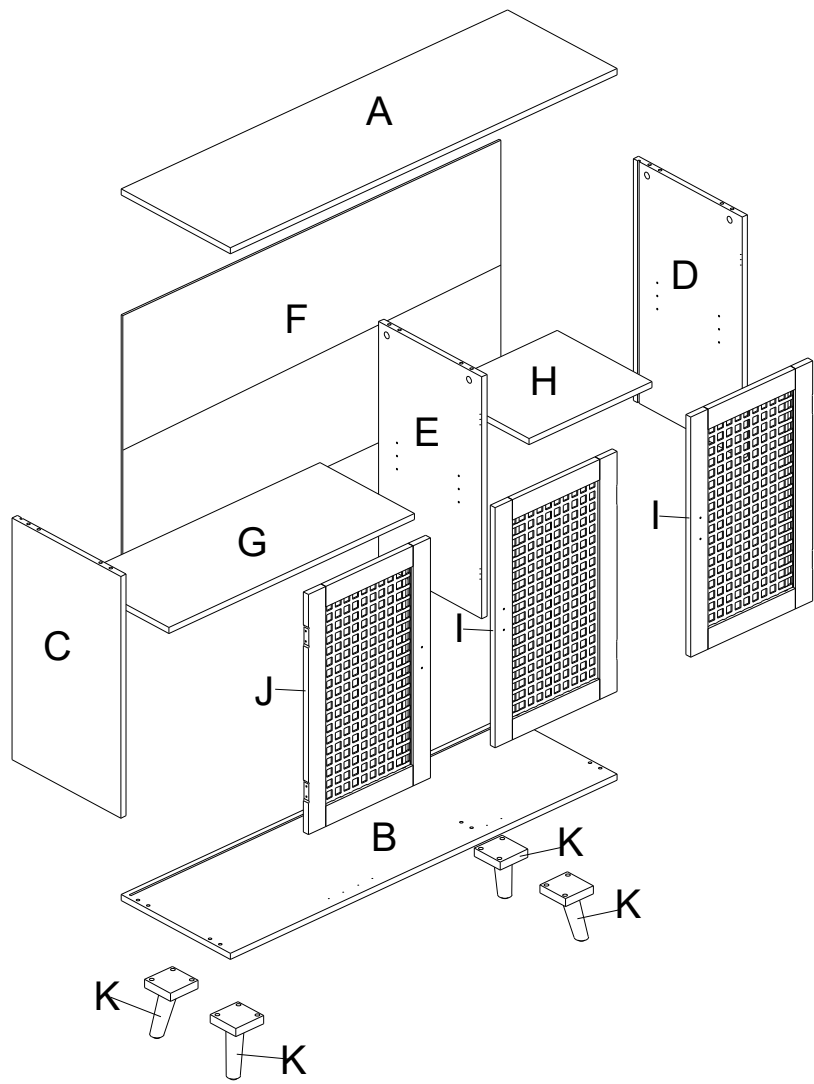

Weight Limitation

100LBS

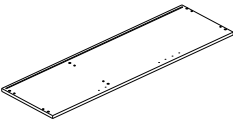
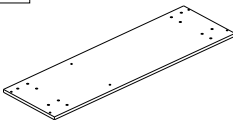

OVERVIEW

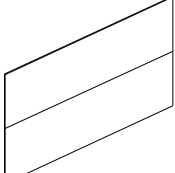
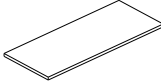
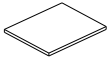
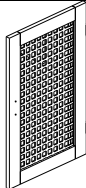
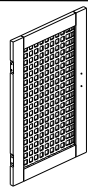

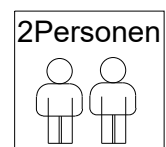

HARDWARE LIST

A 	B 	C 	D 
1 PC	1 PC	1 PC	1 PC
E 	F 	G 	H 
1 PC	1 PC	1 PC	1 PC
I 	J 	K 	
2 PCS	1 PC	4 PCS	









Persons Required For Assembly:



PARTS LIST 1









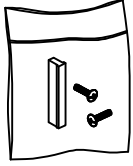

①	x48	②	x6	③	x12	④	x6	⑤	x6
									

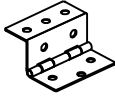
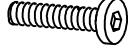
SPARE

①	x2	②	x1	③	x1	④	x1	⑤	x1
									
⑨	x1	⑪	x2	⑫	x1				
									

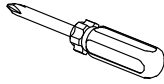

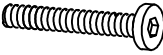
Be sure to inspect all packing material carefully for small parts, that may have come loose inside the carton during shipment.

PARTS LIST 2

⑥	x3	⑦	x6	⑧	x6	⑨	x12	⑩	x6
						 M6*25			
⑪	x8	⑫	x1	⑬	x1	⑭	x1	⑮	x1
									
⑯	x1	⑰	x4	⑱	x4				
		 M6*30							

Be sure to inspect all packing material carefully for small parts, that may have come loose inside the carton during shipment.

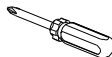

ASSEMBLY INSTRUCTIONS

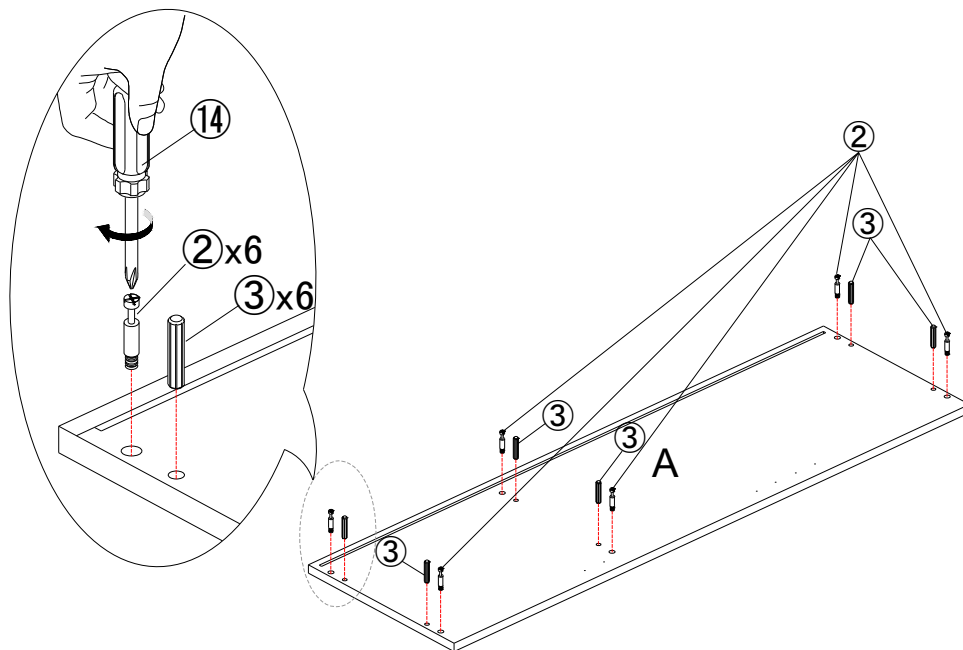
②	x6	③	x6	⑭	x1
					



STEP1:

Insert wooden dowel ③ into the corresponding hole of top panel (A), and then insert bolt ② into the corresponding hole of top panel (A), tighten bolt ② with screwdriver ⑭.

⑦	x6	⑭	x1
			

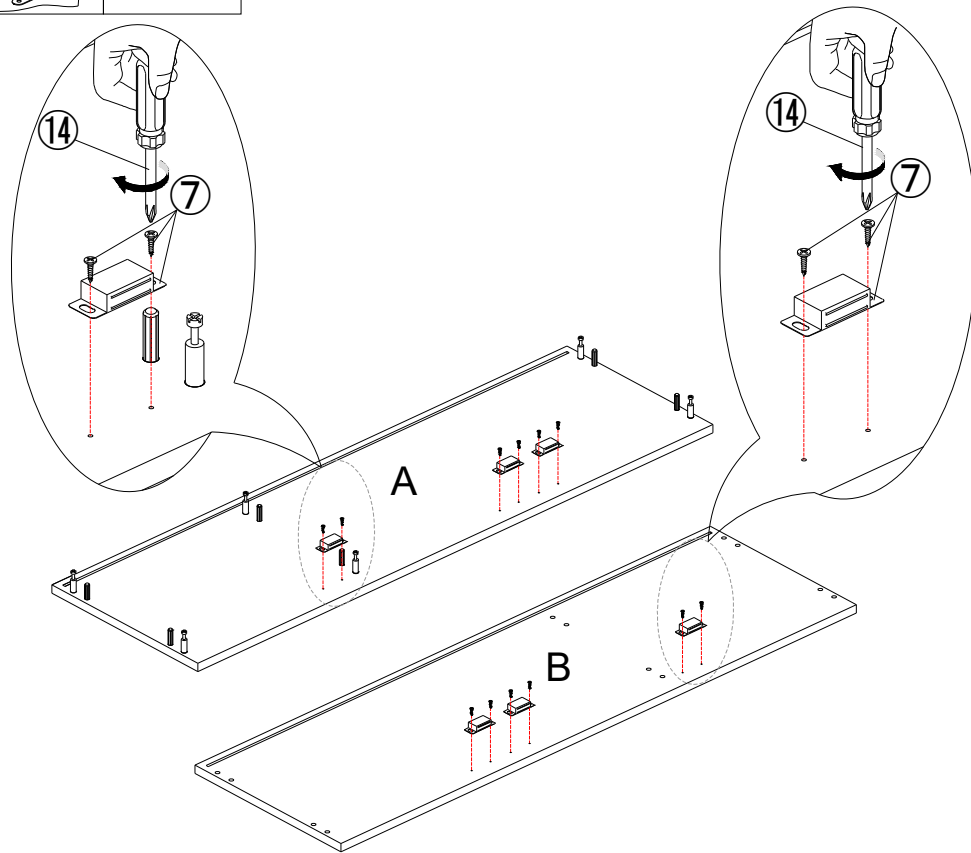

STEP2:

Use nylon packaging Inside screw ⑦ to attach magnetic catch ⑦ to top panel (A)& bottom panel(B),tighten screw ⑦ with screwdriver⑭.

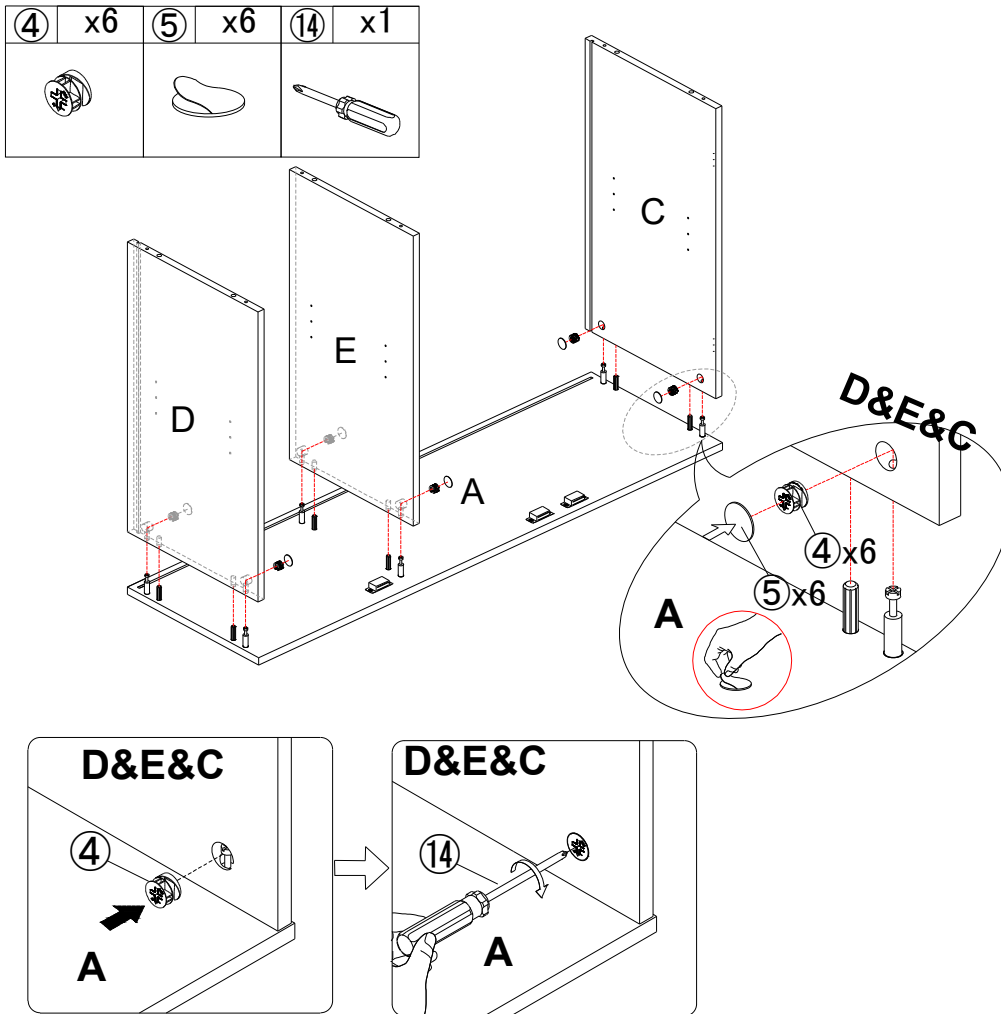

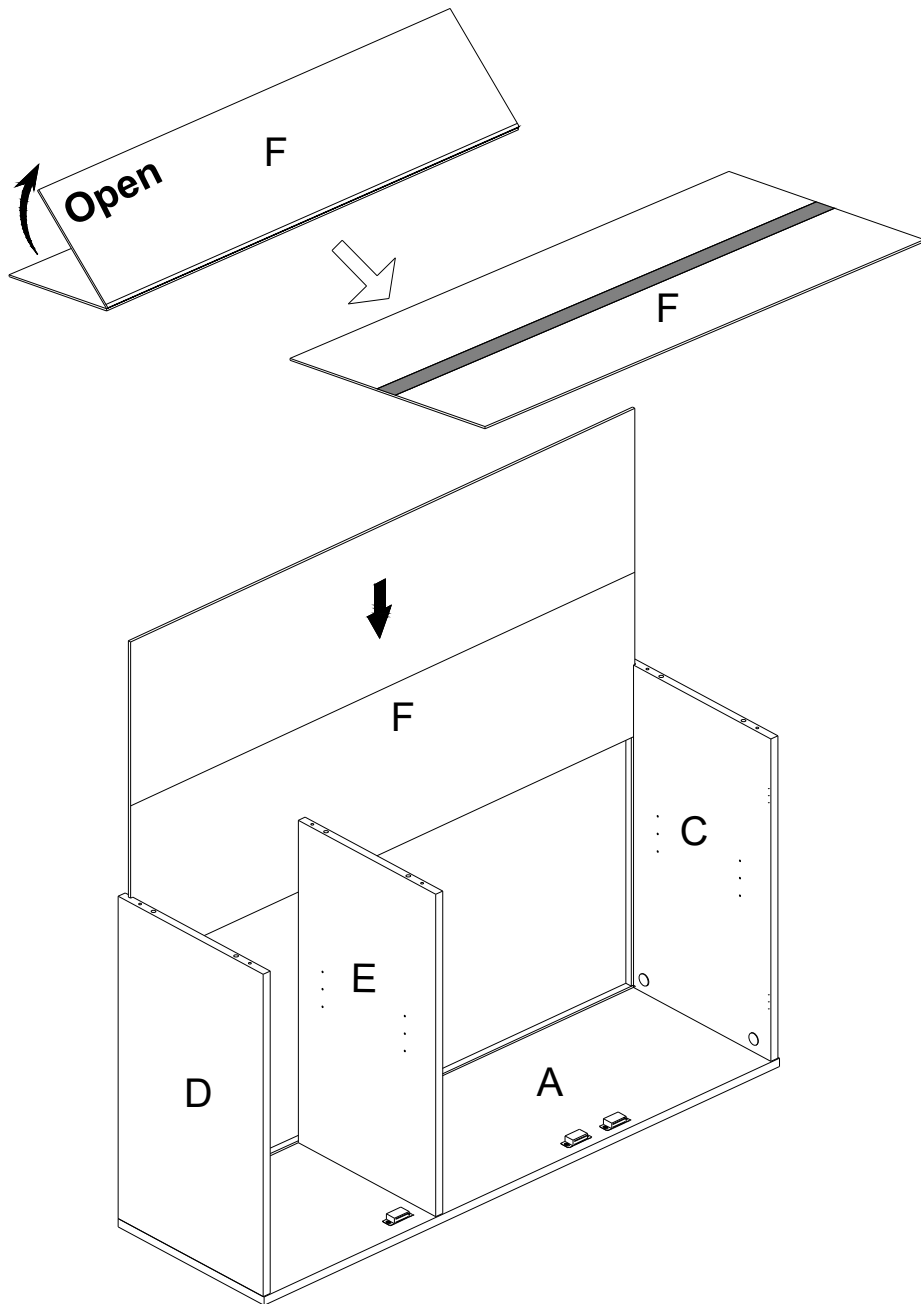

STEP3:

Insert side panel(D)&(C) and middle vertical panel (E) into top panel (A),make sure all holes aligned and then insert cam bolt ④ into the corresponding hole of panel(D)&(E)&(C) as picture show, tighten cam bolt ④ with screwdriver ⑭, finally stick paster ⑤ to it for look nice.



STEP4:



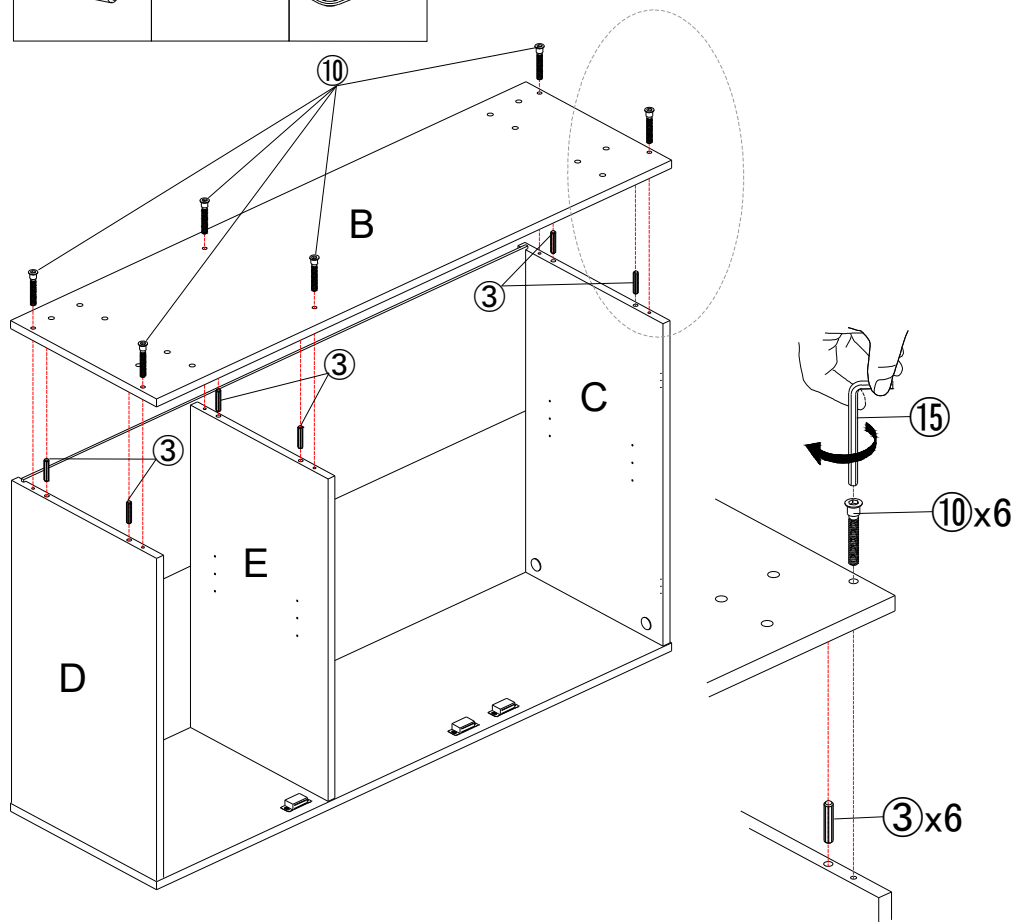

First, open the back panel(F),secondly, carefully align and slide back panel(F) into the groove along rear edge of pre-assembled step 3.

③	x6	⑩	x6	⑮	x1
					



STEP5:

Insert wooden dowel ③ into the corresponding hole of preassembled step 4, and then insert bottom panel (B) into the preassembled step 4, use bolt ⑩ to attach them, tighten bolt with allen key ⑮.

⑨	x12	⑮	x1	⑯	x1	⑰	x4	⑱	x4
									
M6*25						M6*30			

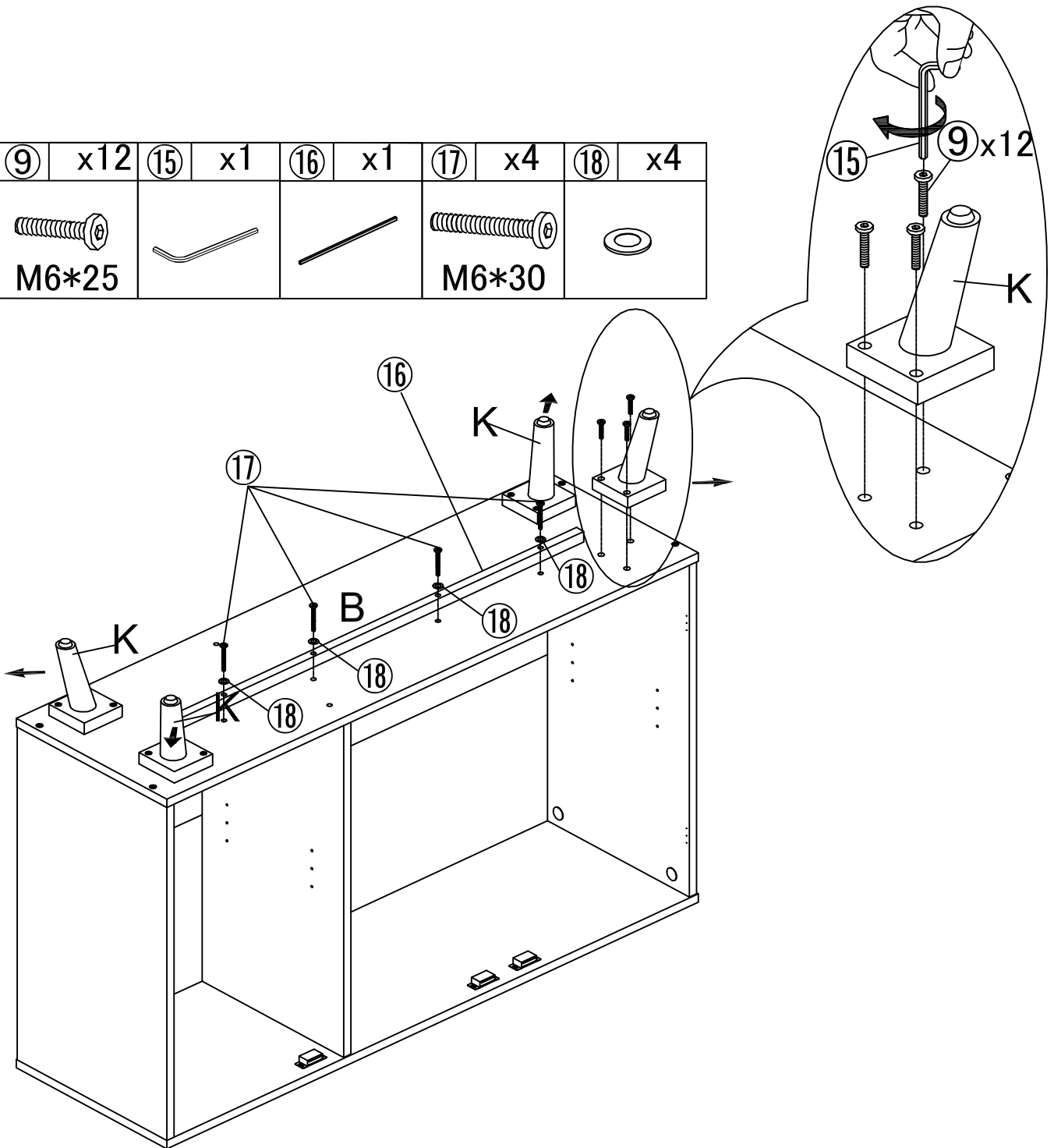

STEP6:

Use bolt ⑨ to attach legs (K) to bottom panel(B),tighten bolt with allen key ⑮



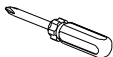

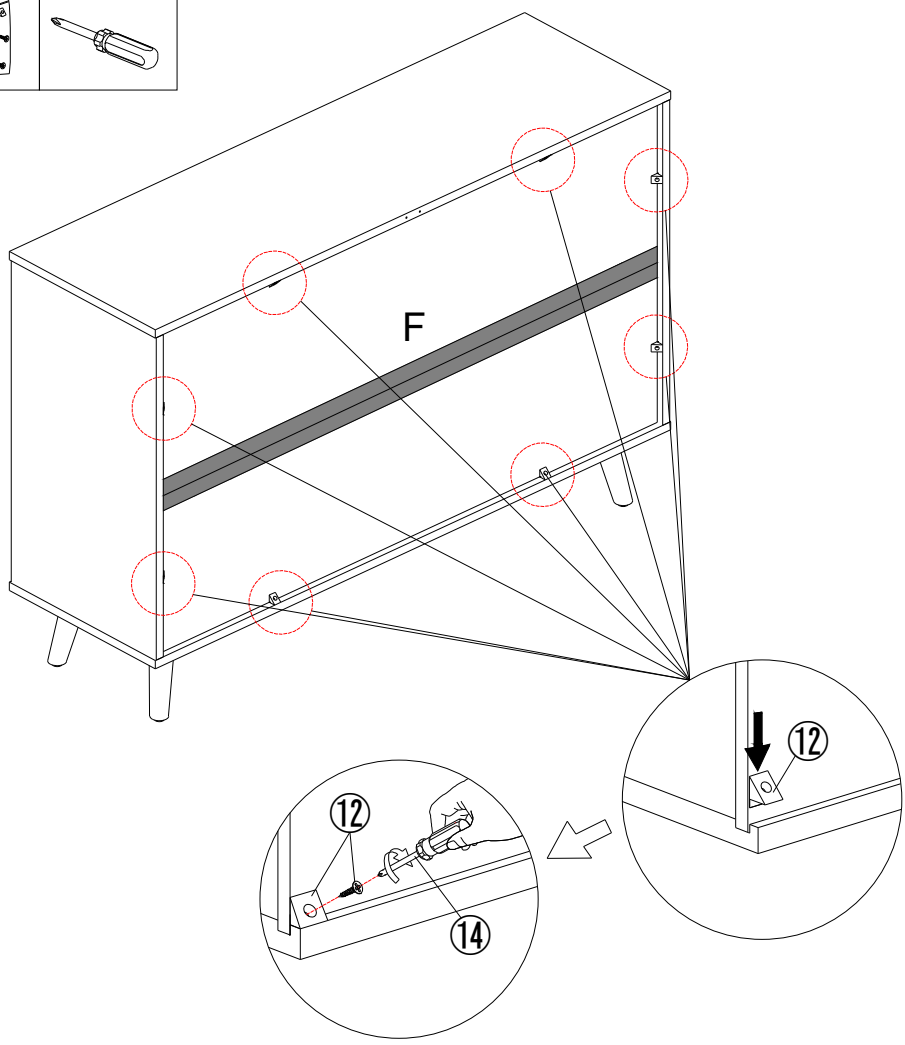
Insert leg ⑯ into bottom panel (B),use plat washer ⑱, and bolt ⑰ to attach them, make sure all holes aligned, and then tighten bolt ⑰ with allenkey ⑨

⑫	x1	⑭	x1
			

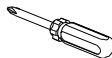

STEP7:

Use nylon packaging Inside bolt ⑫ to attach buckle⑬ to back panel(F),tighten bolt with screwdriver⑭.

①	x30	⑧	x6	⑭	x1	⑦	x6
							

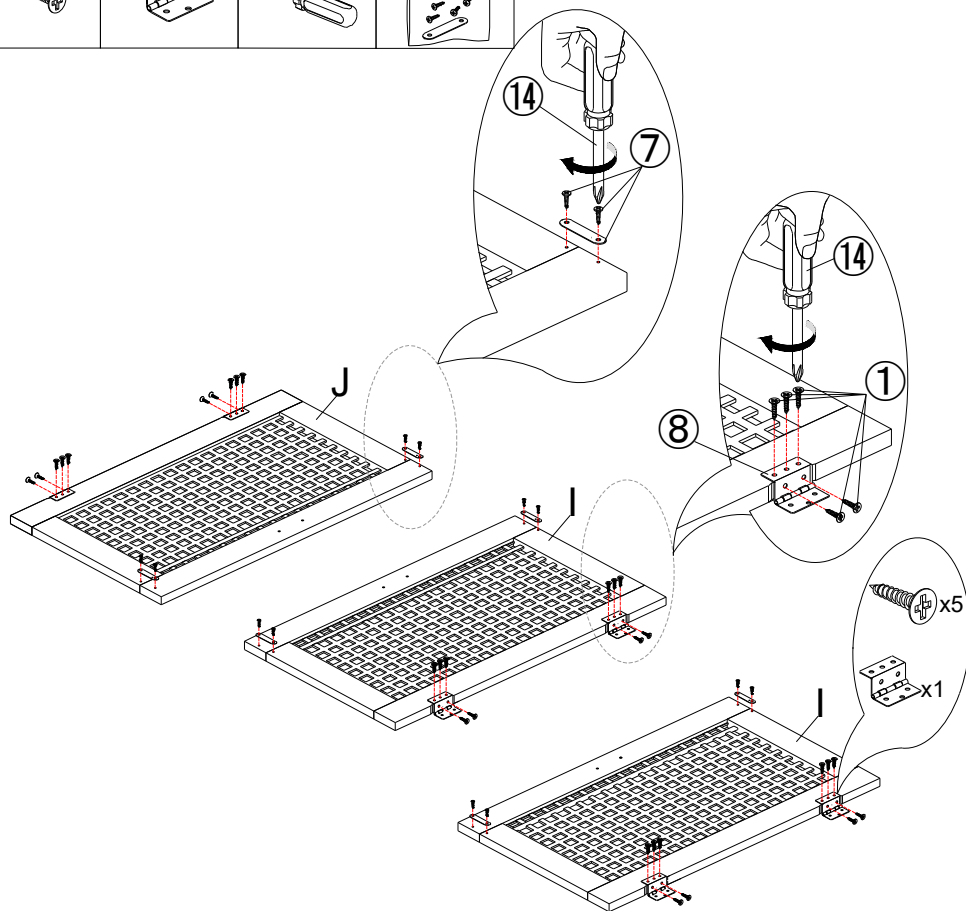

STEP8:

Use screw⑦ to attach metal plate⑦ to door(J)&(I),tighten screw⑦ with screwdriver⑭.

Use screw① to attach hinge⑧ to door(J)&(I),tighten screw ① with screwdriver⑭.

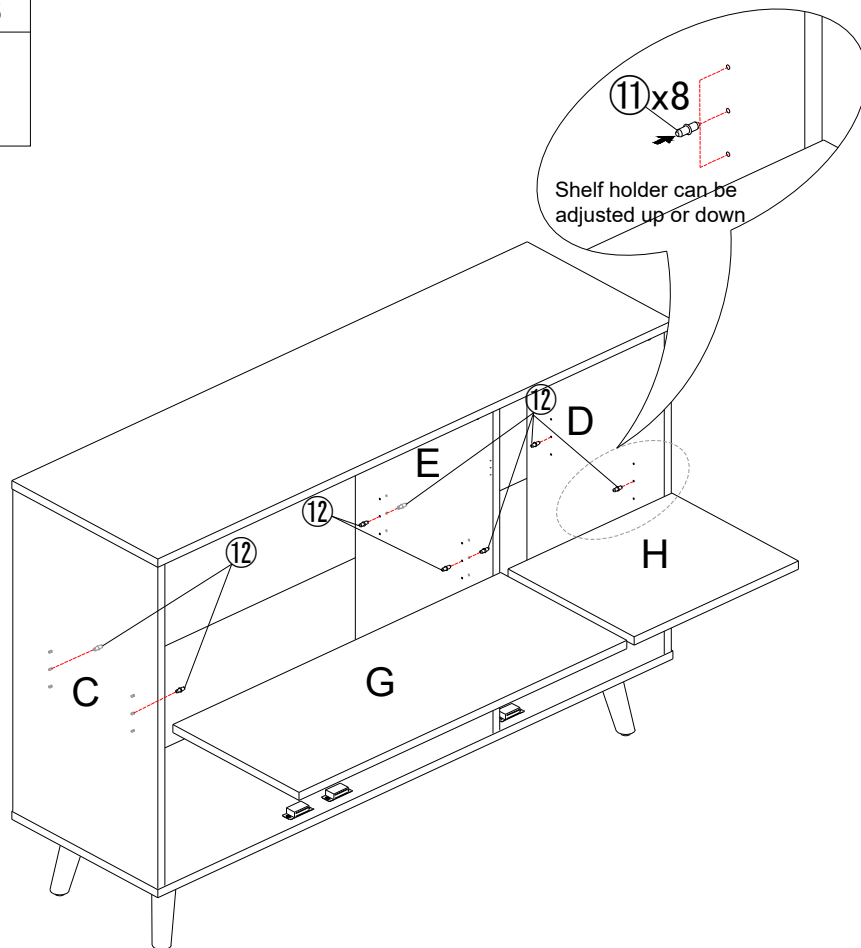
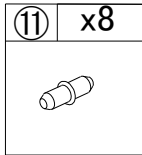

STEP9:

Insert shelf holder ⑪ into side panel(C)&(D)and middle vertical panel (E),and then attach panel (G)&(H) to it.

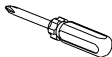
①	x6	⑭	x1
			

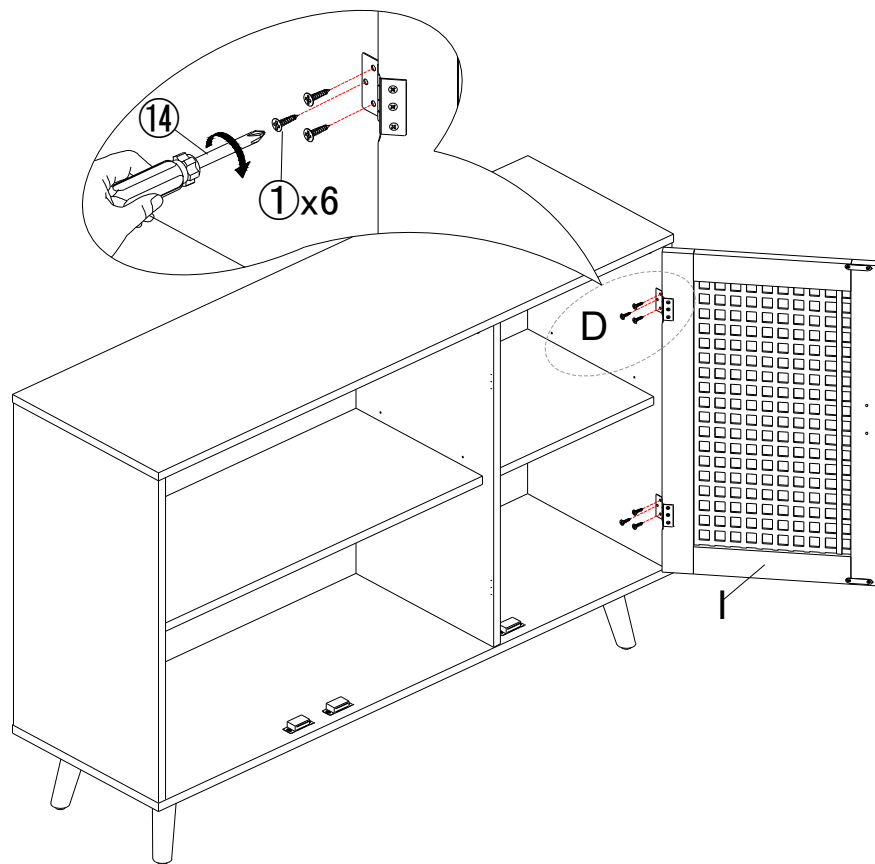

STEP10:

Use screw ① to attach door (I) to the corresponding hole of side panel (D), tighten screw with screwdriver ⑭.

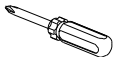
①	x6	⑭	x1
			

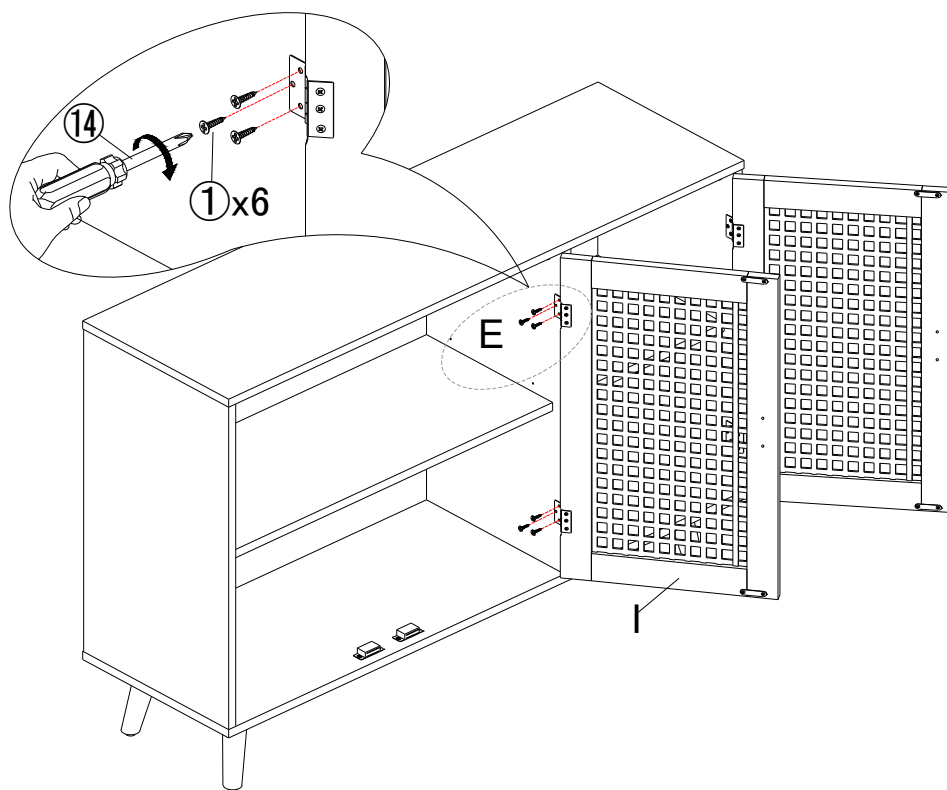

STEP11:

Use screw① to attach door (I) to the corresponding hole of middle vertical panel(E) , tighten screw with screwdriver⑭.

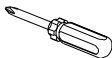
①	x6	⑭	x1
			

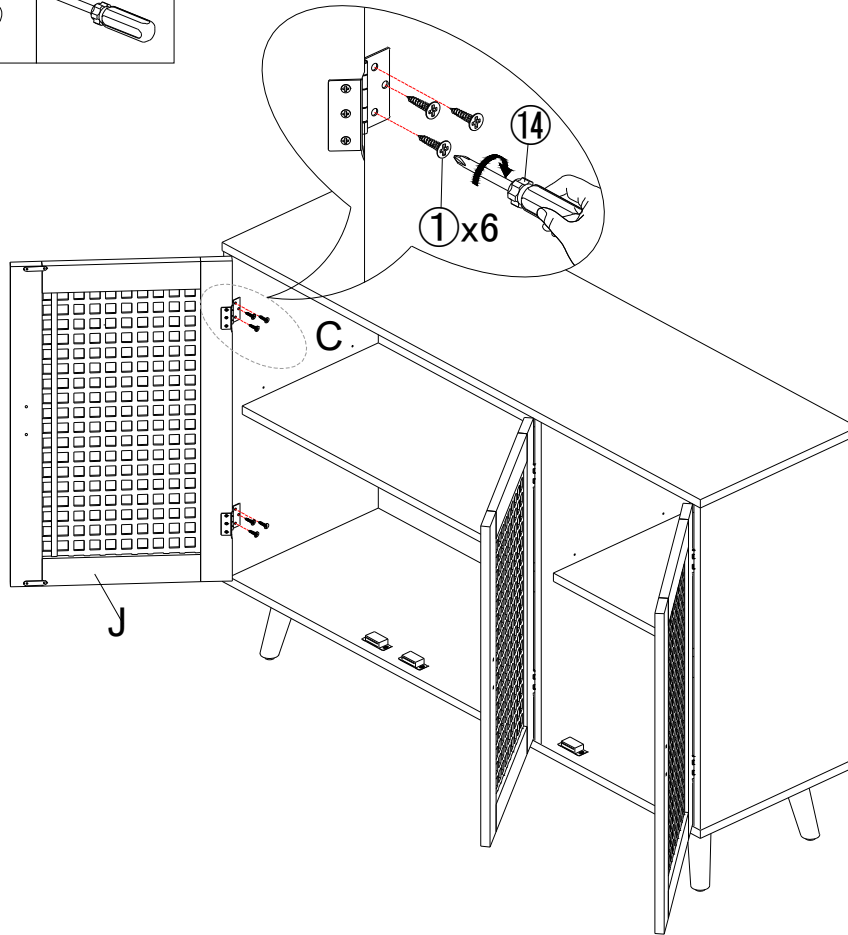

STEP12:

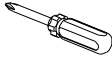

Use screw① to attach door (J) to the corresponding hole of side panel(C) , tighten screw with screwdriver⑭.

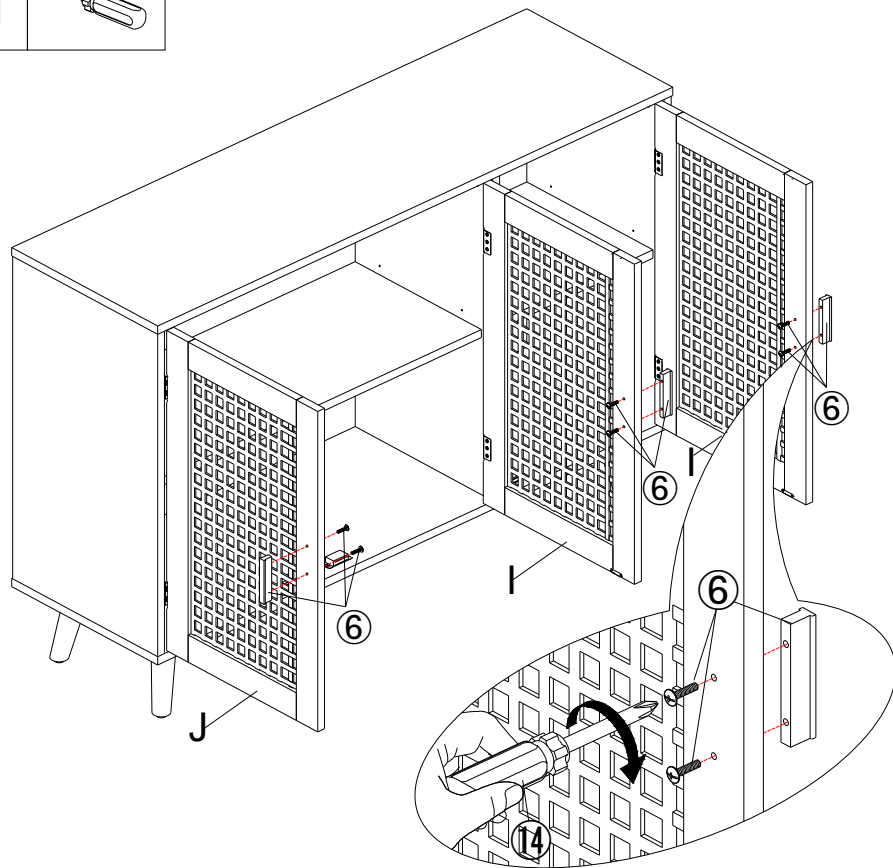
⑥	x3	⑭	x1
			

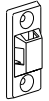

STEP13:

Use screw⑥ to attach handle⑥ to the corresponding hole of door(J) &(I), tighten screw with screwdriver⑭.

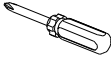
⑬	x1	#1	x1	#5	x2	⑭	x1
							

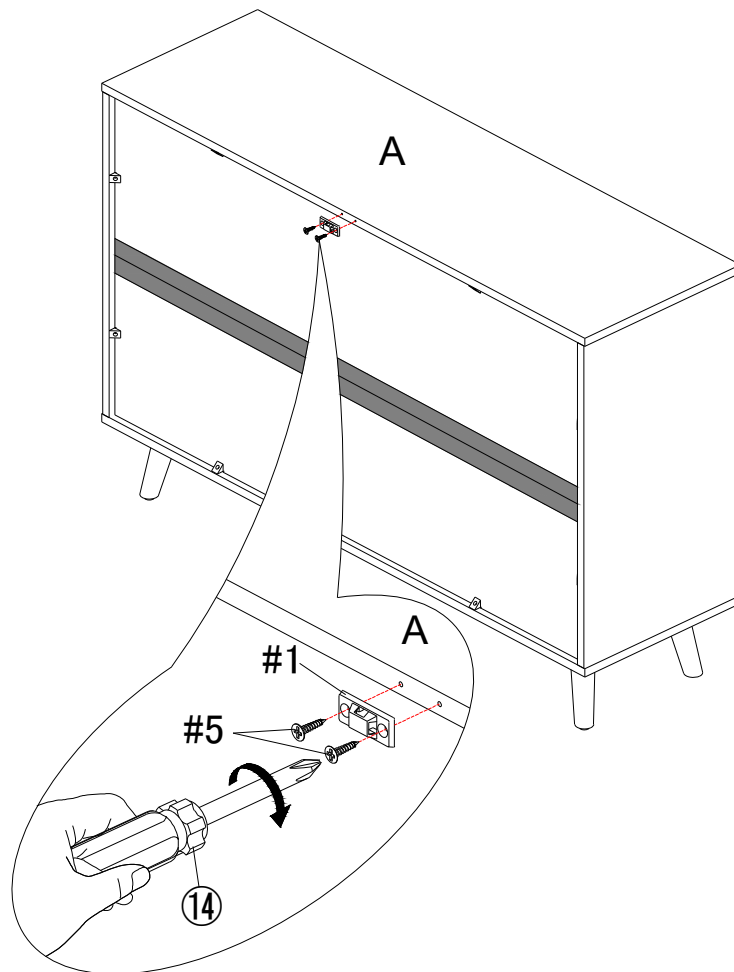

STEP14:

Use nylon packaging⑬ Inside screw #5 to attach bracket #1 to the corresponding hole of top panel(A), tighten screw with screwdriver⑭.

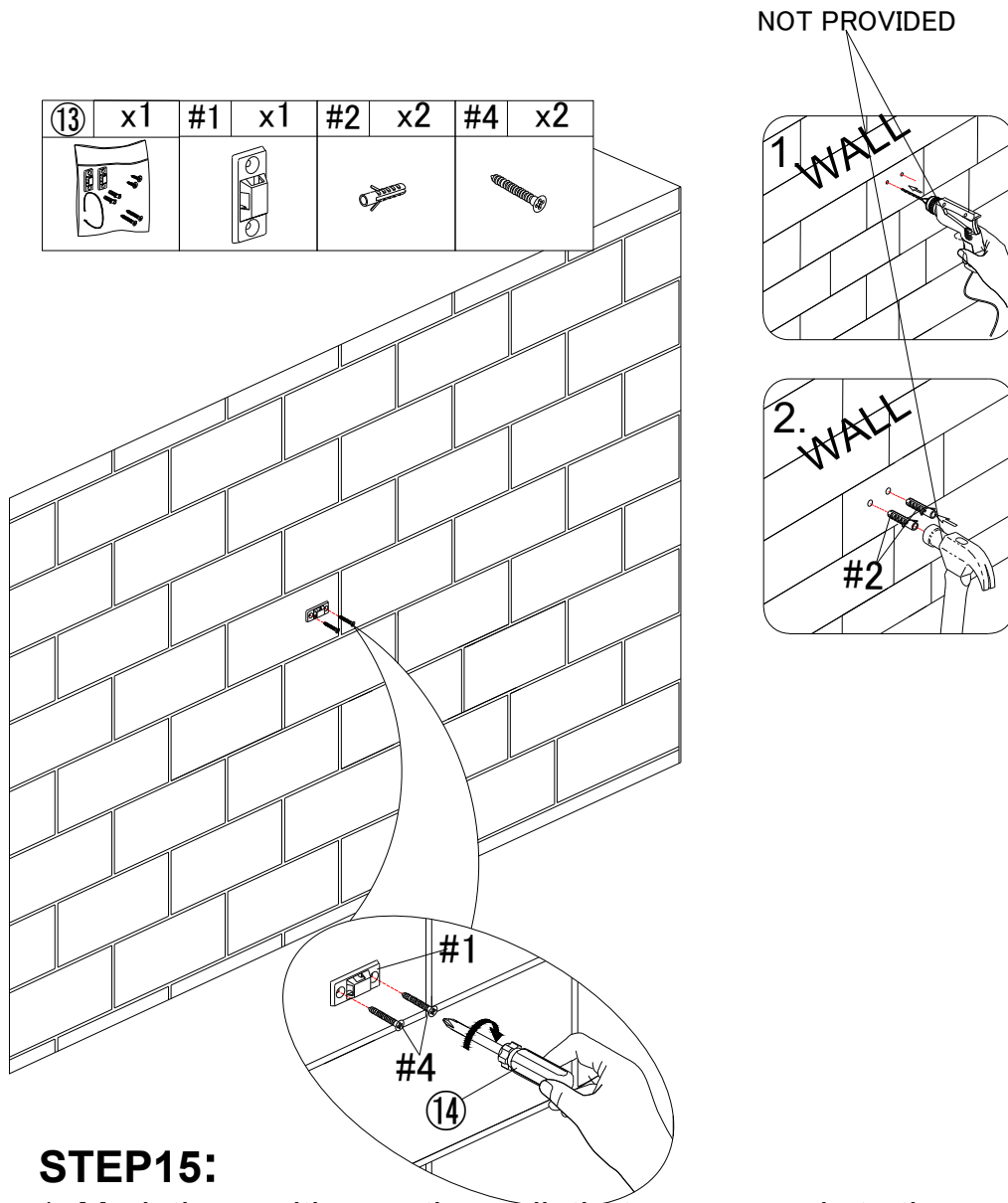

STEP15:

1. Mark the position on the wall, that corresponds to the location of bracket #1 on the back of top panel A; Drill and insert the expandable screw #2 by hammer.
2. Assemble the bracket #1 to the wall. Align the hole in the bracket #1 with the expandable screw #2, use screw #4 to attach it, tighten screw#4 with screwdriver⑬.

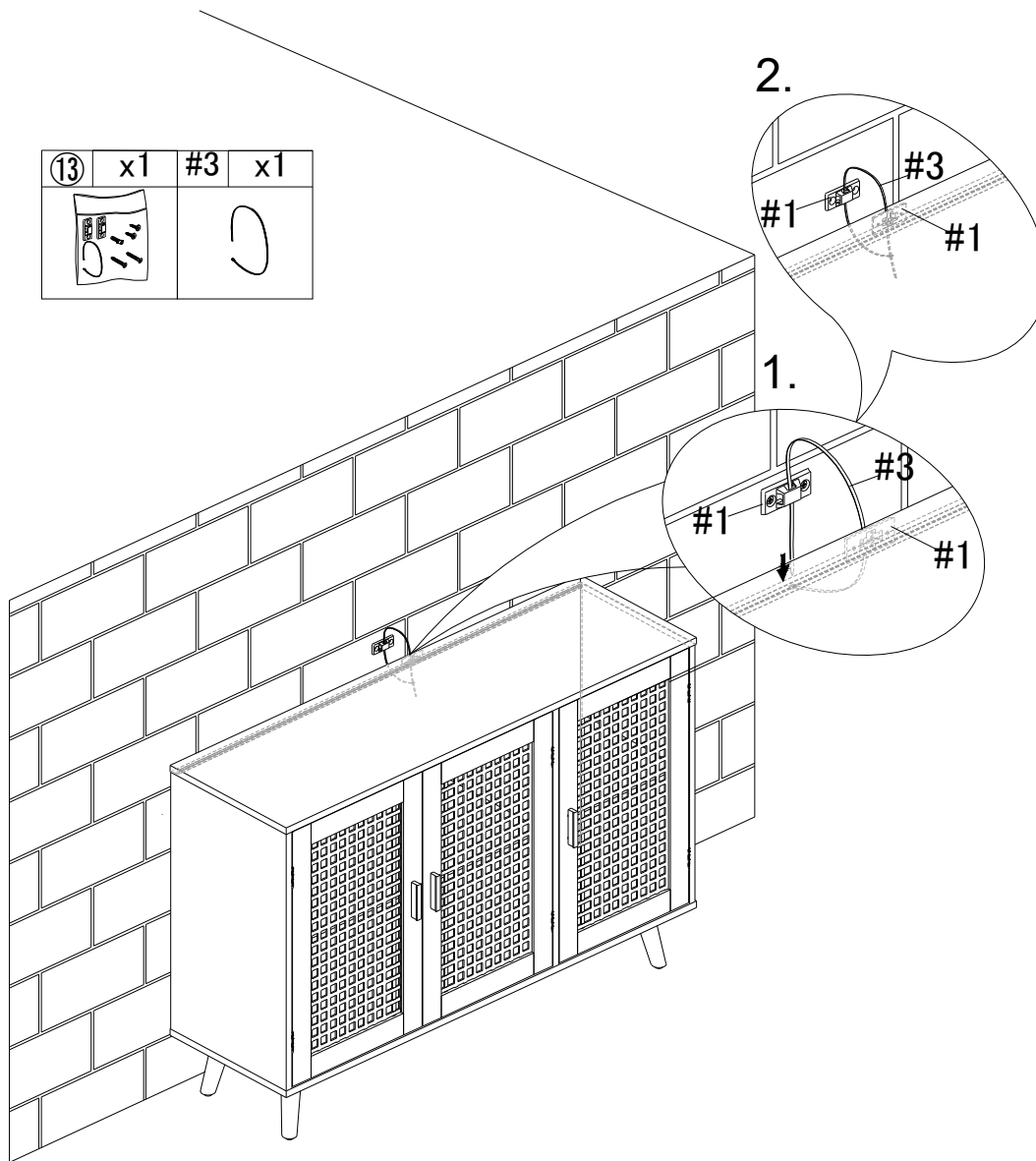

STEP16:

3. Let the plastic belt #3 pass through bracket #1 and pull tightly.

WARRANTY

We strive to offer high-quality products, and we also try our best to satisfy each and every customer that orders from us with product or service as needed. We provide 30 days warranty starting from the time you receive the item. Each customer must provide a record of their order such as the order number, or item receipt for any items that are out of the warranty period you may also still receive replacement parts by purchasing them with our company if they are available.