

Assembly Instructions

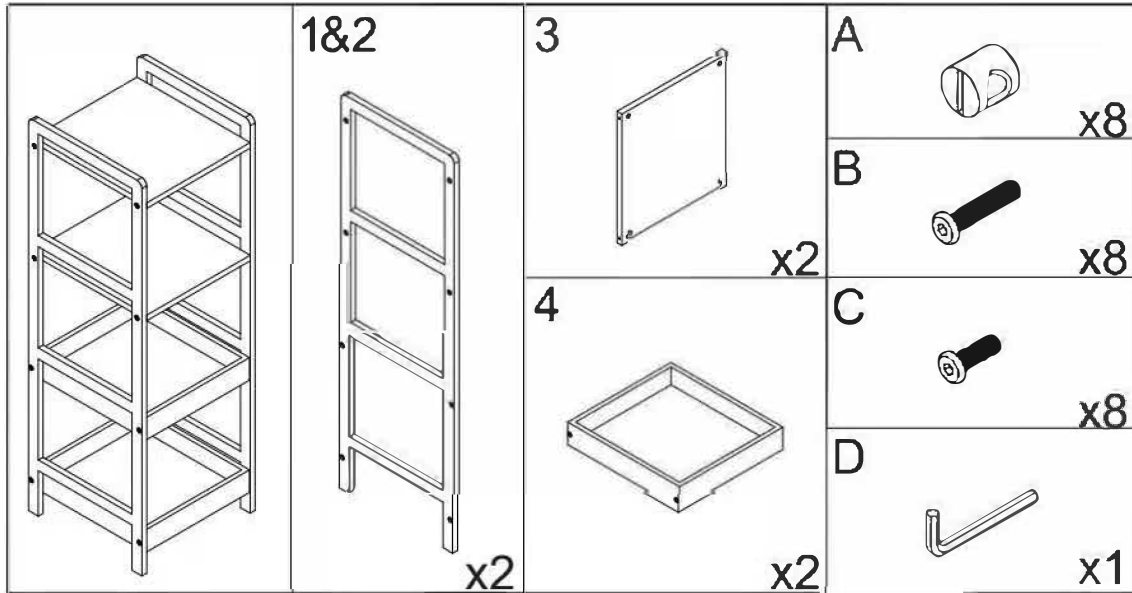

1

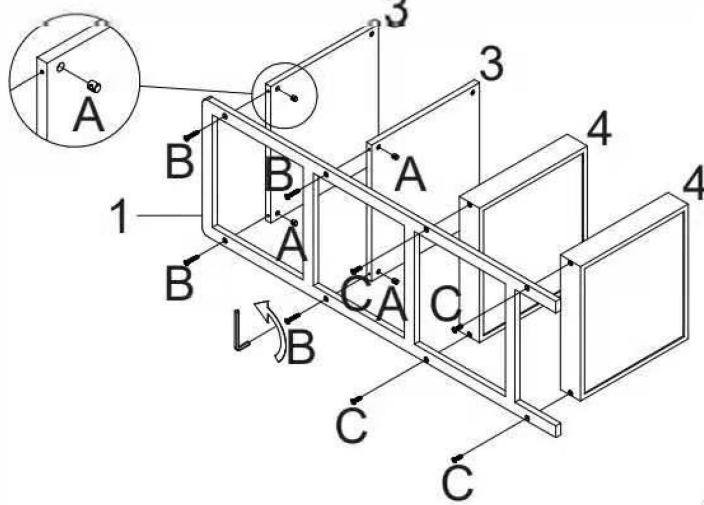

2

