

# YMX-16

## Accessories list

### Carton 1/3

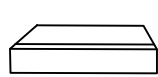

A

Left seat frame(1)

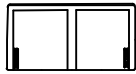

B

Left backrest(1)

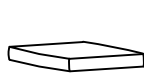

C

Seat cushion(2)

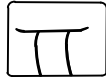

D

Back cushion(2)

### Carton 2/3

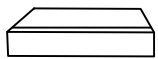

E

Right seat frame(1)

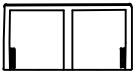

F

Right backrest(1)



G

Double seat cushion(1)

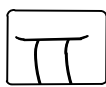

H

Back cushion(2)

### Ottoman carton 3/3

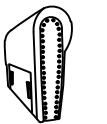

I

Left armrest(1)

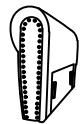

J

Right armrest(1)

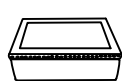

K

Ottoman seat frame(1)

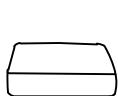

L

Seat cushion(1)

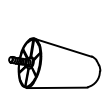

M

Leg(10)



N

Screw(2)



O

Gasket(2)



P

Wrench(1)

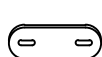

Q

Metal plate(1)

STEP 1:  
Install the sofa feet on the left and right armrest

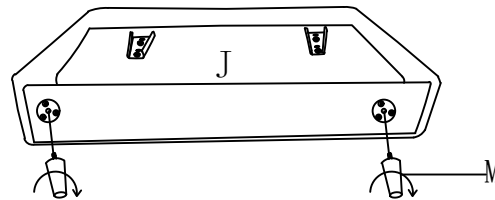
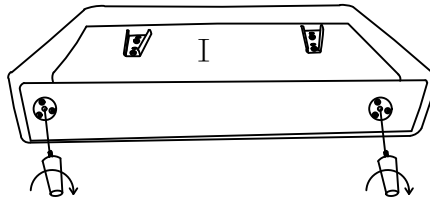

STEP 2:  
Install the sofa feet on the seat frame

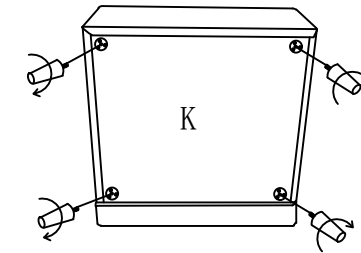
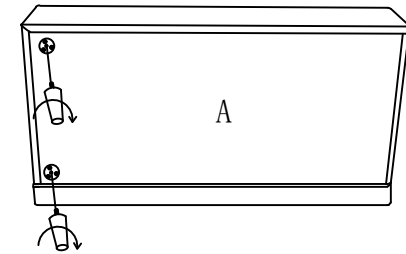

STEP 3:  
Insert the double seat frame into the left armrest

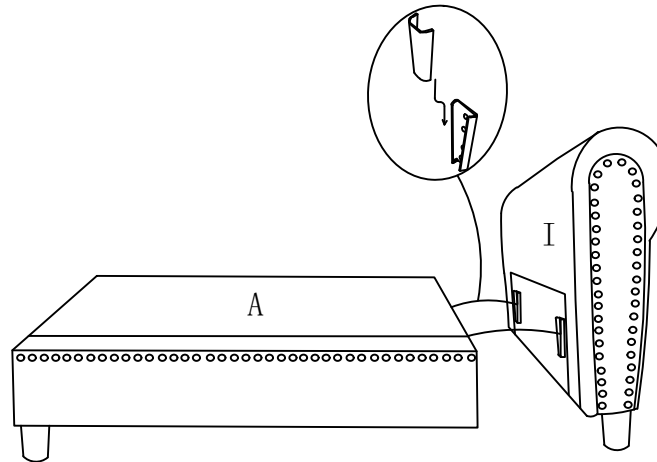

STEP 4:  
Insert the double seat frame into the right armrest

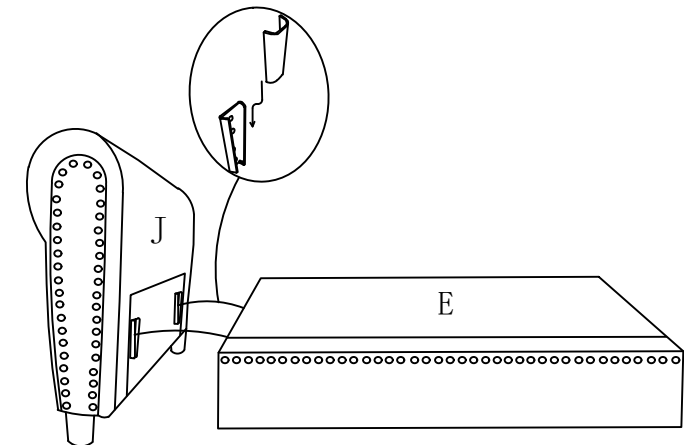

STEP 5:  
Insert right seat frame into left seat frame.

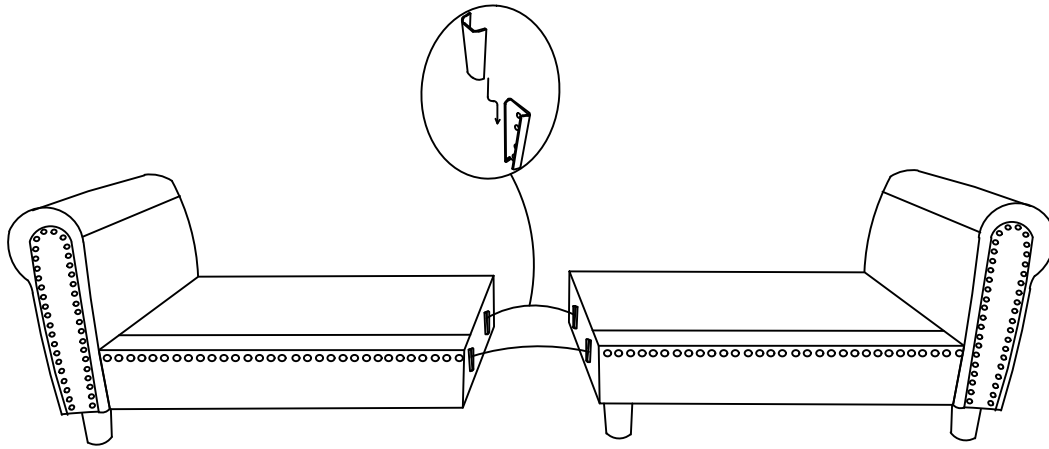

STEP 6:  
Insert backrest into the double seat frame, connect the left and right backrests with backrest hardware.

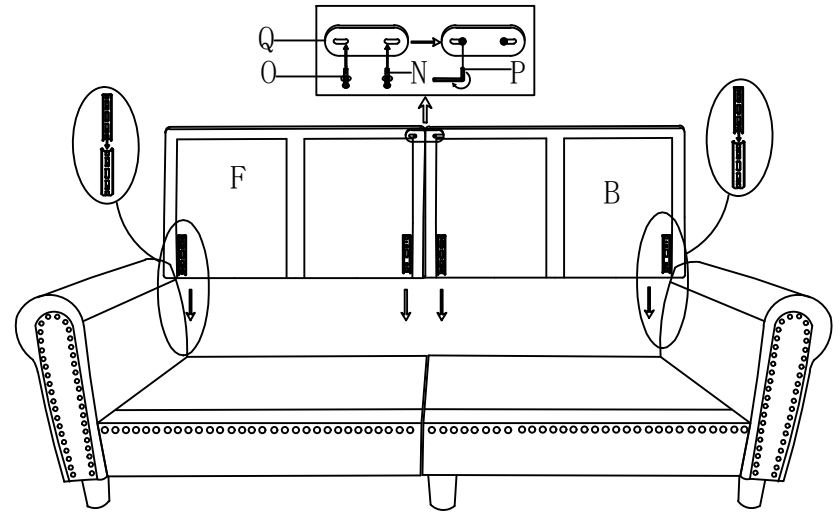

STEP 7:  
Cut the compression bags .

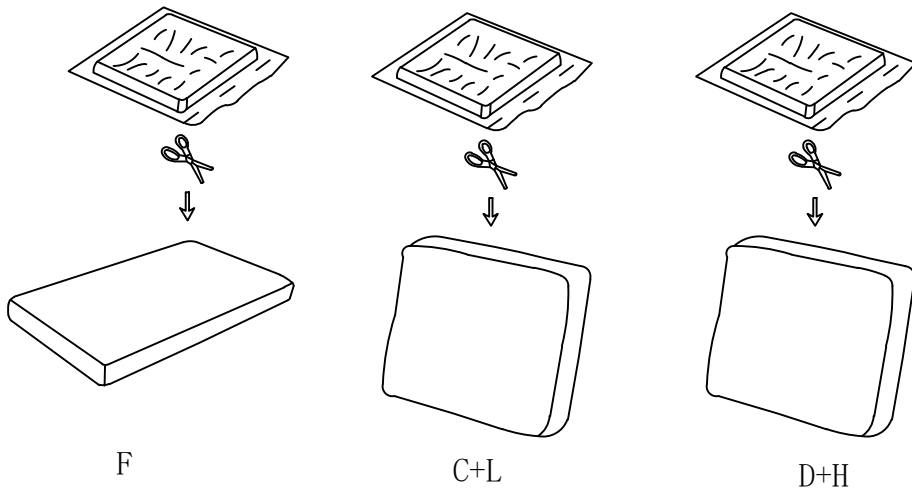

Assembly completed.

