

ASSEMBLY INSTRUCTIONS

KEY PARTS

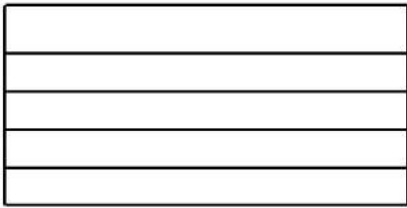

x 1 NOS.



x 2 NOS.



x 1 NOS.



x 6 NOS.

ASSEMBLY

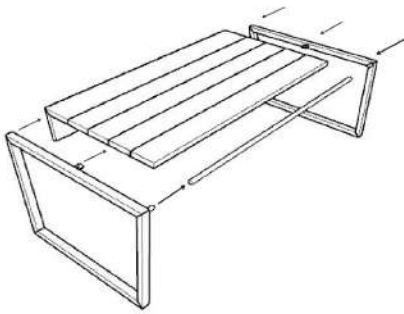

Step-1

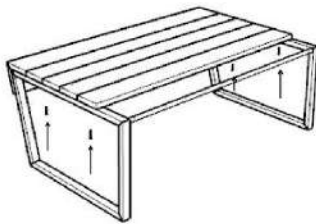

Step-2

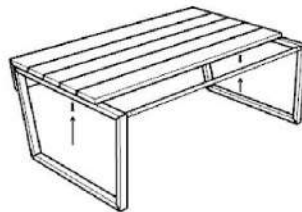

Step-3

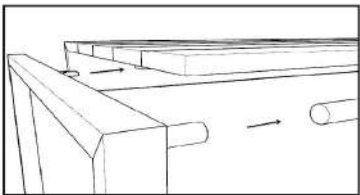

Detail for Step-1

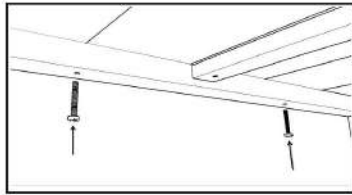

Detail for Step-2

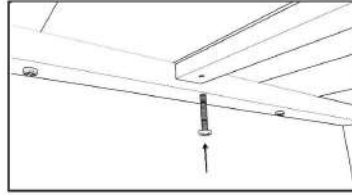

Detail for Step-3

FINAL PRODUCT

