

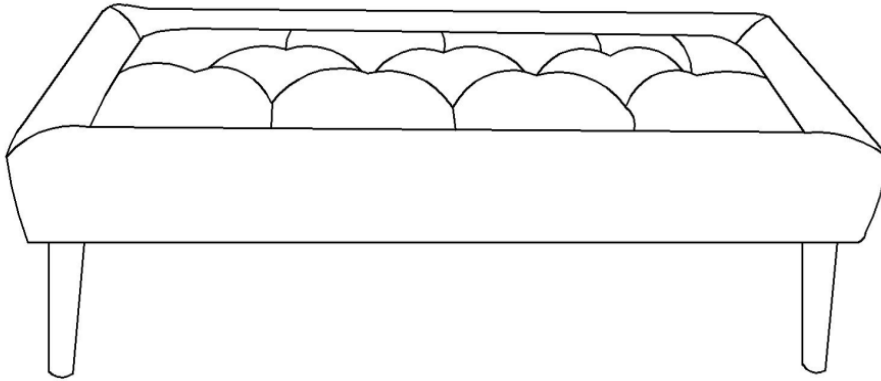

Assembly Instructions

Caution : You must read this before you proceed.



Bench

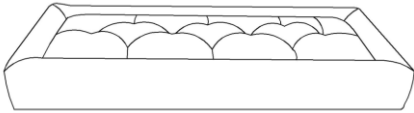



Parts List

Label	Picture	Description	Qty
A		Bench Seat	1
B		Leg	4

Hardware

Label	Picture	Description	Qty
①		Bolt (M8X60mm)	9
②		Spring Washer	9

③		Washer	9
④		Allen Key	1

Assembly Preparation

Before Beginning Assembly:

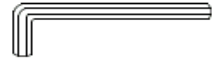
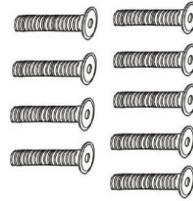
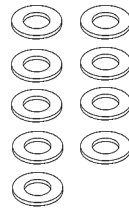
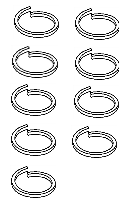
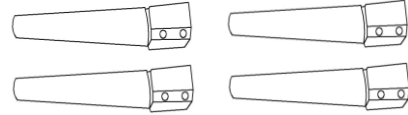
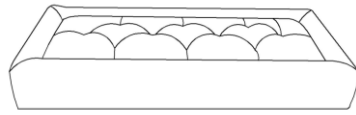

- Read instructions, cover to cover-



- Have 2 adults on hand for assembly-



- Do not assemble on flooring or carpet-



- Assemble on a clean non-marring surface (packing foam)-



- Save all packaging until finished-

Assembly Steps

Overview

Bench Seat(A)

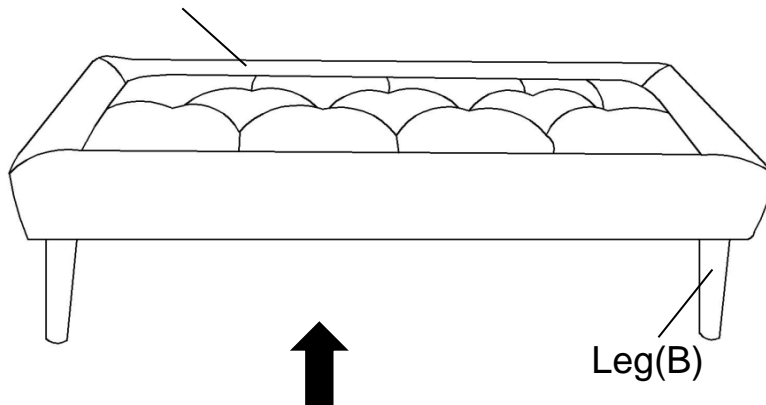

FRONT FACING

This Bench has multiple parts and may require up to 30 minutes to assemble. To give you an overview of the Bench parts, the above picture is to help you put the various parts into perspective. Please read through the instructions below to familiarise yourself with the parts and steps before assembly.

Step 1

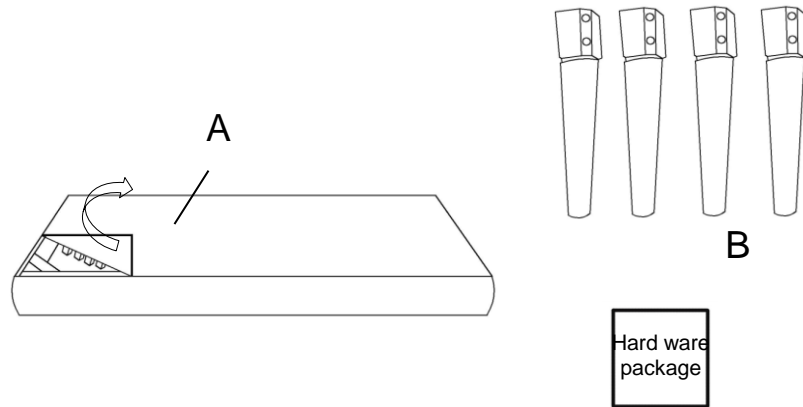

With assistance from your adult partner, Carefully place the Bench Seat(A) face down on a clean, non-marring surface. Remove the non-woven bottom cover as shown in above picture. Take out Legs(B) and hardware package. Open hardware package, and take out all hardware aside.

Step 2

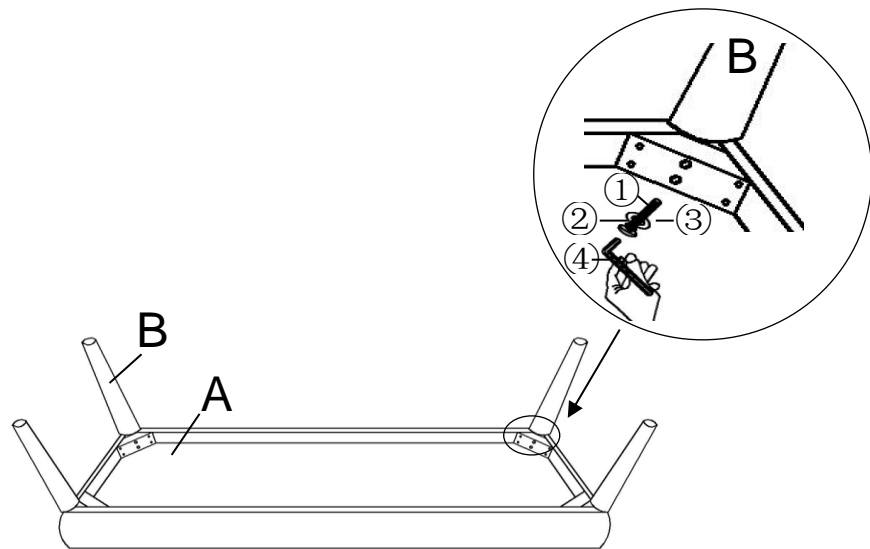

Align the mounting positions on the Legs(B) to those on the underside of Bench Seat(A).

Attach one Legs(B) to Bench Seat(A) using two Bolts(①), two Washers(②) and two Spring Washers(③) with Allen Key(④).

DO NOT tighten a Bolt fully and then move on towards another one.

Repeat the same process with the remaining three Legs.

Step 3

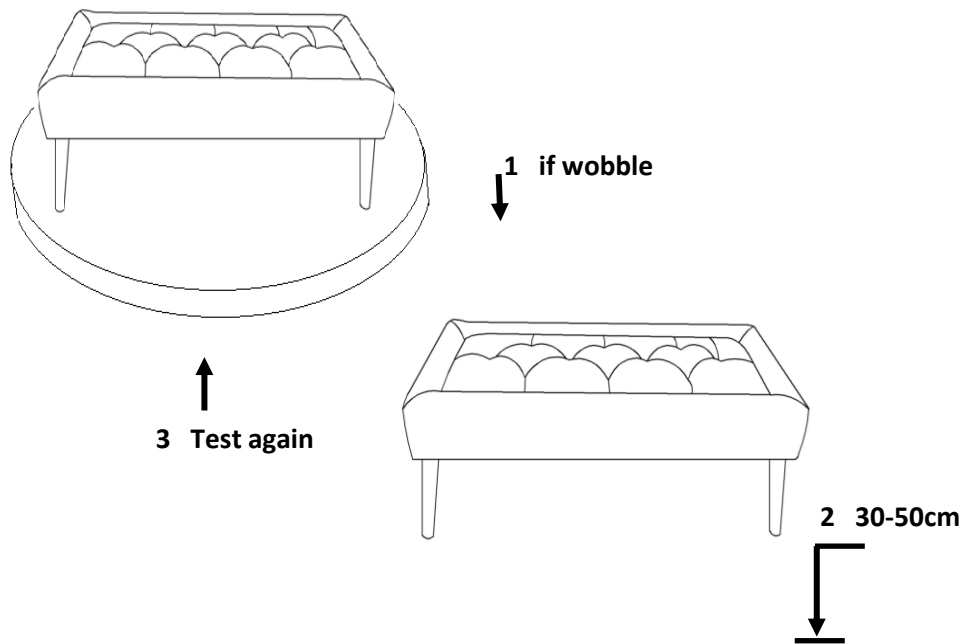

Place the Bench on a level Surface to check if it wobbles.

If it wobbles, lift the Bench some 30cm to 50cm high from the ground.

Keep your feet and toes well away from the drop zone.

Drop the Bench freely and vertically, with all four legs hitting the ground at the same time.

This Drop Test will help to ensure that all the Parts, Bolts, and gaps reach full alignment status.

Test again for evenness on a Level Surface.

If no wobbles are found, proceed to tighten all the Bolts.

When tightening the Bolts, tighten sequentially.

Do not fully tighten any Bolt fully and then move on towards the next one.

This may cause the frame to warp.

If there are still wobbles, loosen the Bolts and execute this same drop test.

Step 4

Step 4.1

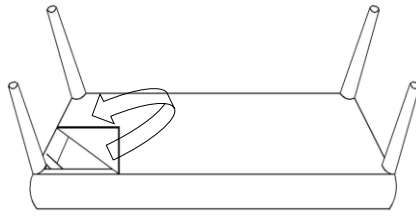

Step 4.2

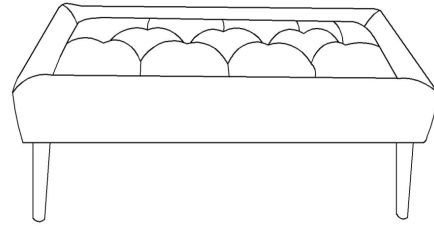

Step 4.1

Lay down the Bench facedown on a clean non-marring surface. Seal the non-woven bottom cover back to the underside of the Bench.

Step 4.2

Stand the Bench up. Inspect and make sure all parts are connected, locked and fully secured into position.



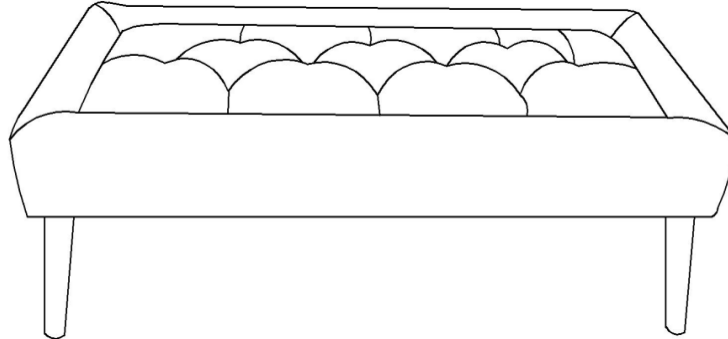















Step 5



Your Bench is ready for use.

This Bench can only be used on a flat, level surface.

Care & Maintenance

-   ● Do not put hot items directly on furniture surface
 -   ● Do not clean furniture with harsh cleansers or polish.
 -   ● To obtain the longest lifespan of your outdoor products, minimizing exposure to direct sunlight is recommended.
 -   ● Children should not climb or jump on the furniture.
 -   ● Do not write on furniture without a padded barrier to protect the surface.
 -   ● To obtain the longest lifespan of your outdoor products, avoid extended and lengthy exposure to rain, snow, and direct sunshine. Whenever possible cover the product and /or place under patio or awnings.
 -   ● Not for commercial use. For residential use only .
 -   ● Stains may be removed with mild soap solution and damp cloth.
-
-   ● Dust and pick-up spills using a clean, non-colored, lint-free cloth .

Questions & Answers about Proposition 65

• What is Proposition 65?

Proposition 65 requires businesses to provide warnings to Californians about significant exposures to chemicals that cause cancer, birth defects or other reproductive harm. These chemicals can be in the products that Californians purchase, in their homes or workplaces, or that are released into the environment. By requiring that this information be provided, Proposition 65 enables Californians to make informed decisions about their exposures to these chemicals.

Proposition 65 also prohibits California businesses from knowingly discharging significant amounts of listed chemicals into sources of drinking water.

Proposition 65 requires California to publish a list of chemicals known to cause cancer, birth defects or other reproductive harm. This list, which must be updated at least once a year, has grown to include approximately 900 chemicals since it was first published in 1987.

• What types of chemicals are on the Proposition 65 list?

The list contains a wide range of naturally occurring and synthetic chemicals that include additives or ingredients in pesticides, common household products, food, drugs, dyes, or solvents. Listed chemicals may also be used in manufacturing and construction, or they may be byproducts of chemical processes, such as motor vehicle exhaust.

• What does a warning mean?

If a warning is placed on a product label or posted or distributed at a workplace, a business, or in rental housing, the business issuing the warning is aware or believes that it is exposing individuals to one or more listed chemicals.

By law, a warning must be given for listed chemicals unless the exposure is low enough to pose no significant risk of cancer or is significantly below levels observed to cause birth defects or other reproductive harm.

• Where can I get more information on Proposition 65?

If you have specific questions on the administration or implementation of Proposition 65, you can contact OEHHA's Proposition 65 program at P65.Questions@oehha.ca.gov, or by phone at (916) 445-6900.