











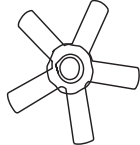

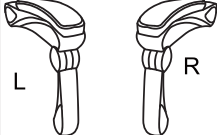
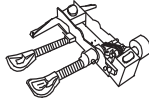

ASSEMBLY INSTRUCTIONS

Office Chair

Thanks for choosing our product. Please kindly check parts listed below and read this manual carefully, then assemble them step by step. Please feel free to contact us for any questions.

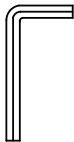

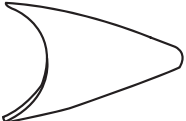
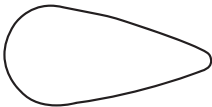
Parts List																			
A X1  Backrest	B X1  Seat	C X1  Chair Base	D X5  Chair Base	E X1  Gas Lift Cover	F X1  Gas Lift	G X5  Casters	H X1  L R Armrests	I X1  Support Hardware	J X1  T-bar	K X8  M6x55mm	L X12  M6x16mm	M X4  M6x20mm	N X4  Cap	O X4  Shim	P X1  L-shaped Bracket	Q X1  Remote	R X1  Plug	S X4 	T X4 

Office Chair Assembly Instruction

STEP 1

* Assemble 5 casters under the base, insert two gas lifts (E, F) tightly.

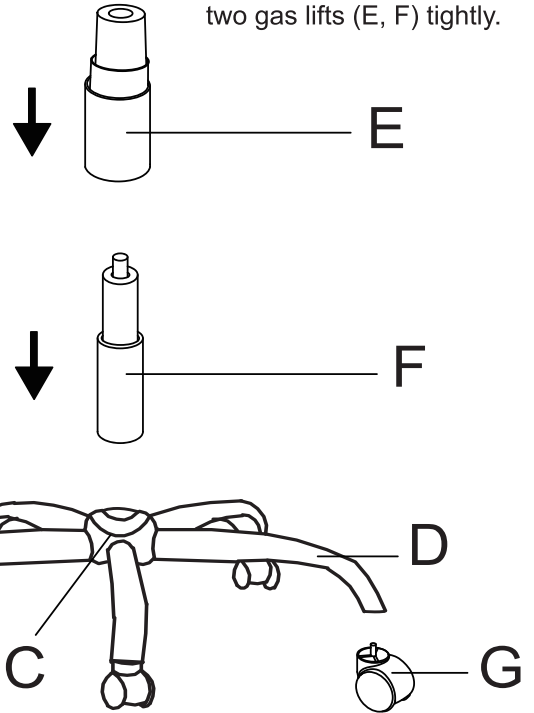
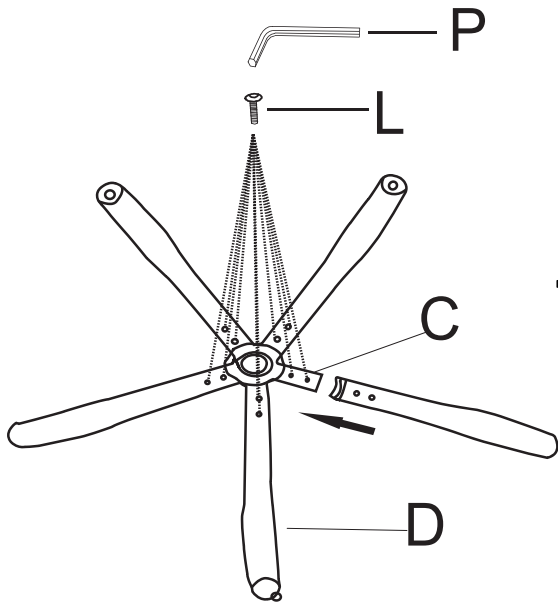

STEP 2

* There are 2 parts on T-bar, straight side will be connected on backrest, and bent side will be connected to seat mechanism.

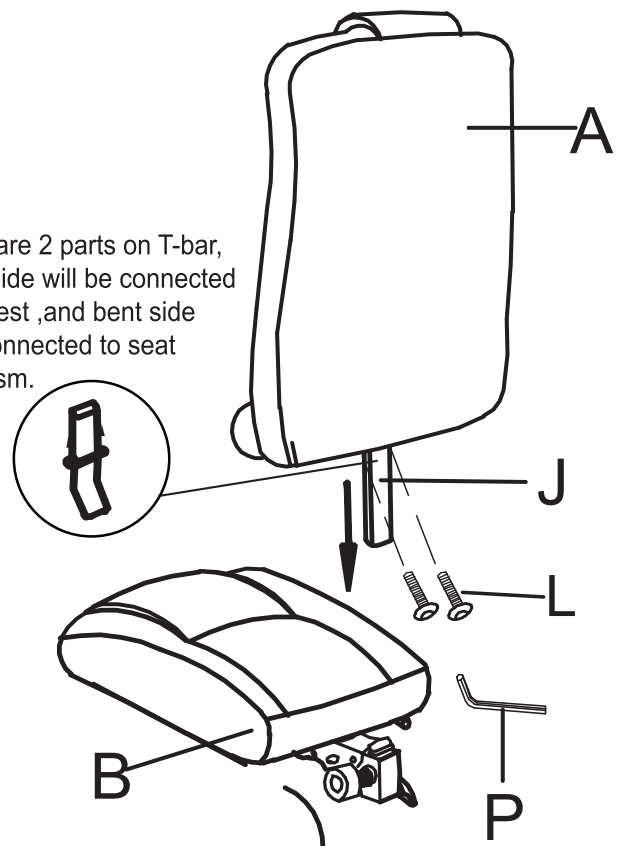
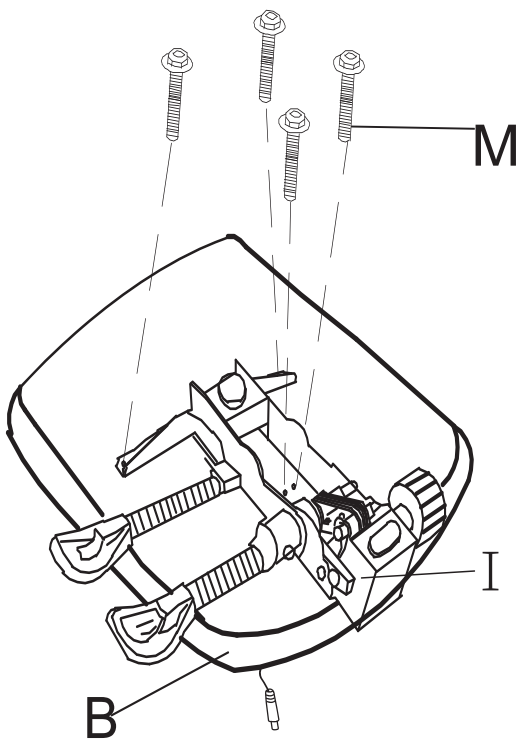

Office Chair Assembly Instruction

STEP3

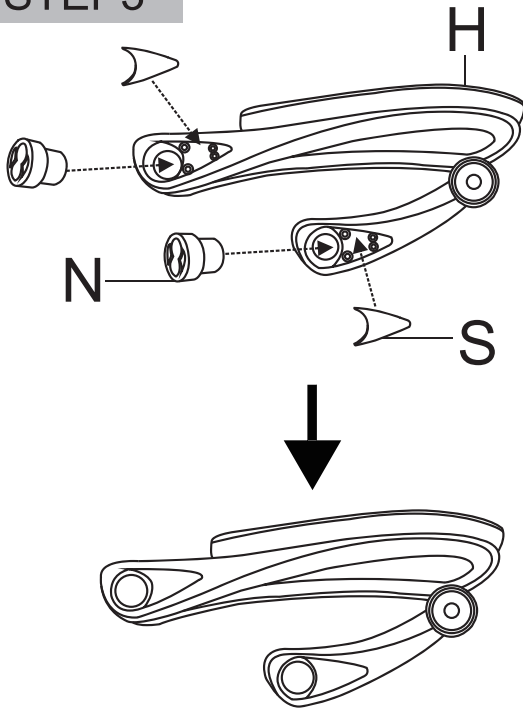

Tips : First install S into H, then insert N into the chair, It will be easier to install H into the chair at last.

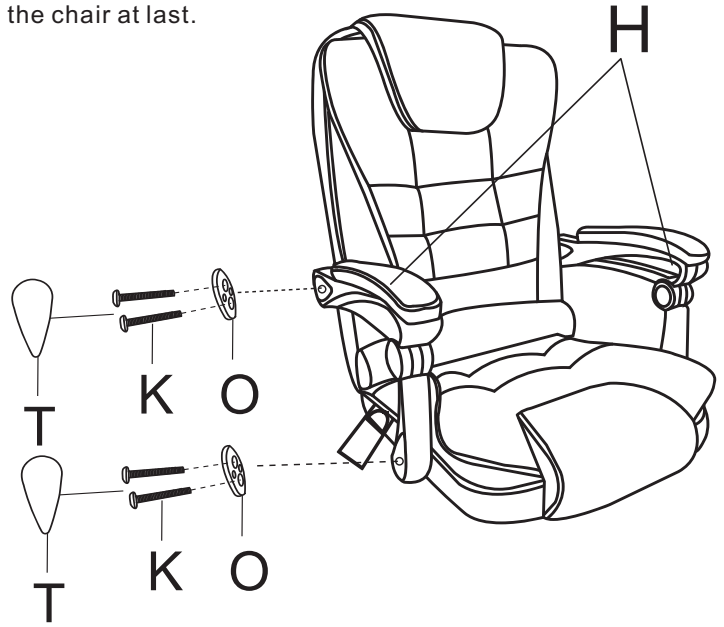

STEP4

* NOTE : Two same color wires connect.

- (a) + (b) wire connects with the backrest and chair base.
- (c) wire connects with chair base and power cord (R).
- (d) wire connects with backrest and remote control (Q).

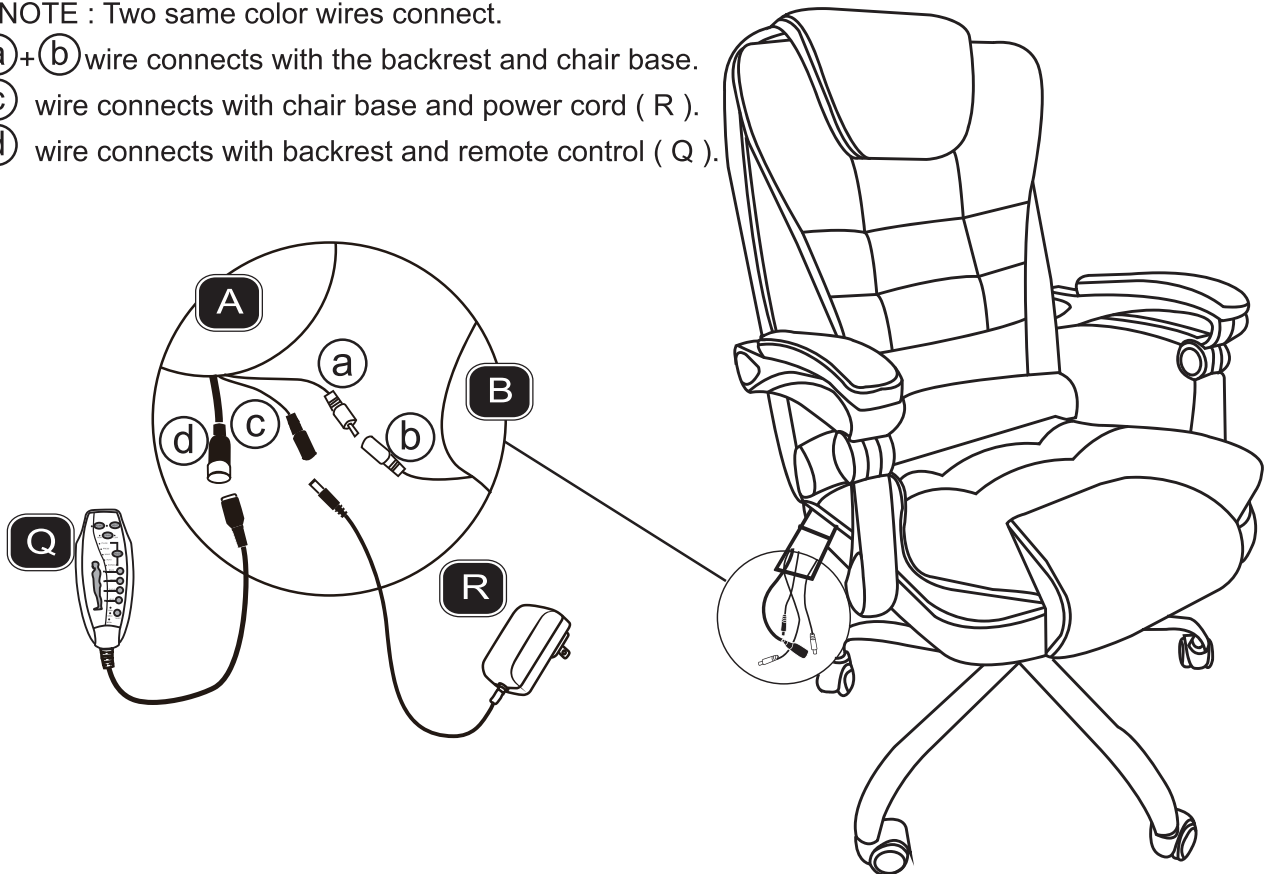

Office Chair Assembly Instruction :

STEP5



* Use the remote control to control the chair and enjoy the massage moment.

