

# WARNING

- \* Switch off the main electrical supply from the main fuse box / circuit breaker before installation.
- \* Inspect item carefully before attempting to install.
- \* If there is any damages or obvious defects, do not install.
- \* Item may not be returned once it has been installed.

# CARE AND MAINTENANCE











- \* To clean the outside of the fixture, use a dry or slightly dampened clean cloth (use clean water, never a solvent) to wipe the surface of the fixture.
- \* To clean the inside of the fixture, first disconnect power to the fixture by turning off the circuit breaker or by removing the fuse at the fuse box. Next, use a dry or slightly dampened clean cloth (use clean water, never a solvent) to wipe the interior surface of the fixture.
- \* Do not use any cleaners with chemical, solvents or harsh abrasives. Use only a dry soft cloth to dust or wipe carefully.

# NOTICE& IMPORTANT SAFETY INSTRUCTIONS

**\*\* WE RECOMMEND INSTALLATION OF THIS LIGHTING FIXTURE BE DONE BY A LICENSED ELECTRICIAN \*\***

- \* Please make sure that you have all parts indicated before you begin assembly of this item
- \* This item should be assembled on a soft surface to prevent scratching the finish during assembly
- \* To reduce the risk of fire, electrical shock or injury to persons or property, please follow the guideline below for safe use and installation
- \*The external flexible cable or cord of this lamp cannot be replaced  
If the cord is damaged, the lamp shall be destroyed

## Part List and Hardware List

PIECE	DESCRIPTION	PICTURE	QUANTITY	PIECE	DESCRIPTION	PICTURE	QUANTITY
A	machine screw		3X	G	Canopy		1X
B	canopy nut		1X	H	Light Body		1X
C	Mountien Srew		2X	I	Glass Shade		1X
D	Ground Screw		1X	J	Lamp capring		1X
E	Wire Connector		1X	K	Bulb		1X
F	Canopy Nut		1X				

**Product Dimensions: 6"L X 7"W X 13.25"H**

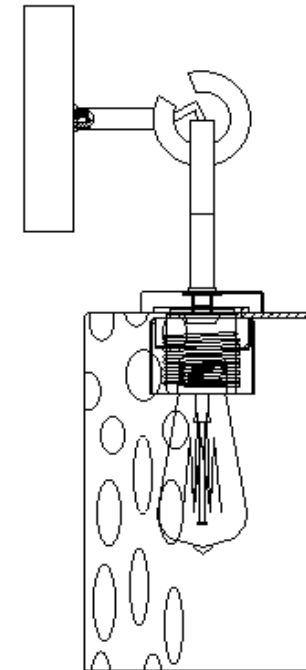

# PREPARATION

- \* Before beginning assembly of product, make sure all parts are present. Compare parts with package contents list and hardware contents list.
- \* If any part is missing or damaged, do not attempt to assemble the product.
- \* Estimated Assembly Time: 20 minutes.
- \* Tools Required for Assembly (not included): Screwdriver, Junction box
- \* If you are having difficulty, our friendly Customer Care team is always here to help.

**NOTE: PLEASE USE ON/OFF TYPE "B" BULB MAX 40-WATT OR LED BULB MAX 9-WATT. THERE IS LED 4-WATT BULB IN THE BOX**

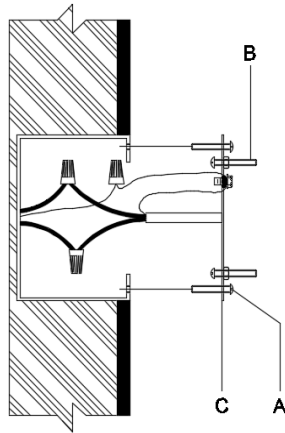

**Step 1:** Unpack all parts from cartons carefully.  
Fix the Mounting plate (C) to the junction box with machine screw (A).

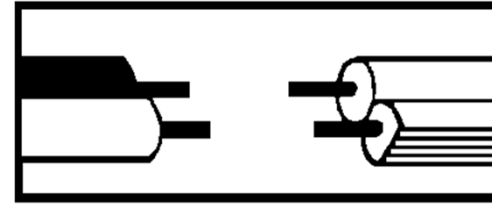

## Step 2: Wire connection

Connect fixture neutral wire (ribbed) to the outlet box neutral wire (usually white) using a wire nut.

Connect fixture hot wire (smooth with markings) to the outlet box hot wire (usually black) using a wire nut.  
Grounding Instructions:

Wrap ground wire from outlet box around green ground screw on mounting bracket, no less than 2" from wire end. Tighten ground screw. If fixture is supplied with a ground wire, connect to outlet ground wire with a

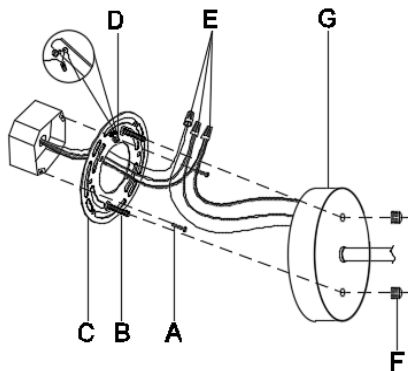

**Step 3:** Attach the Canopy (G) to the Mounting Plate (C), and tighten it by turning the canopy nut (F).

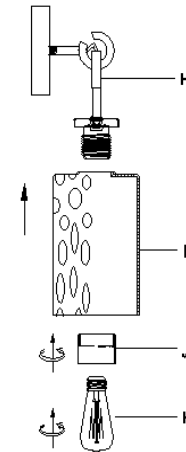

**Step 4:** Fix the bulb (H) into the lamp holder