









# ACCENT CHAIR

PARTSLIST		
LABEL	PICTURE	QTY
A		1
B-L		1
B-R		1
C		1
D		1
E		1
HARDWARE		
LABEL	PICTURE	QTY
F	M6X16 	4
G	M6X30 	11
H		4
J		1

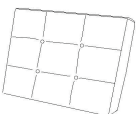

**Step1**

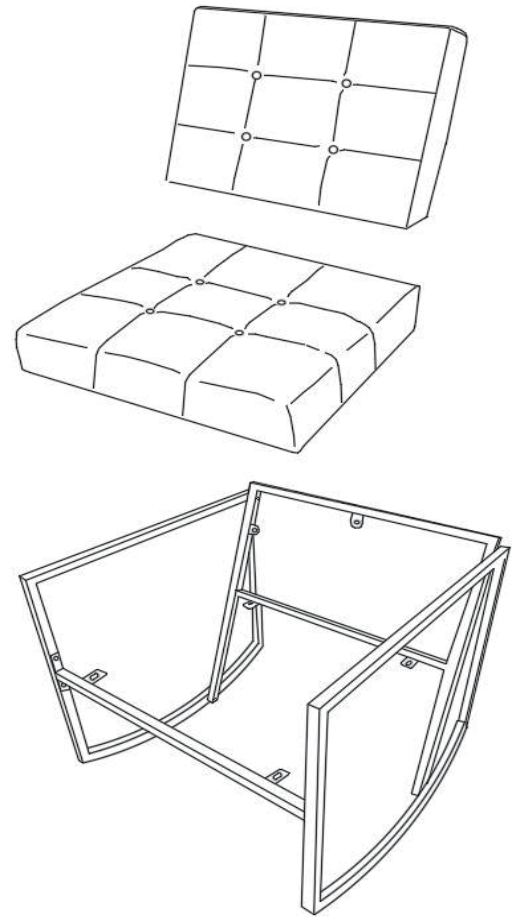
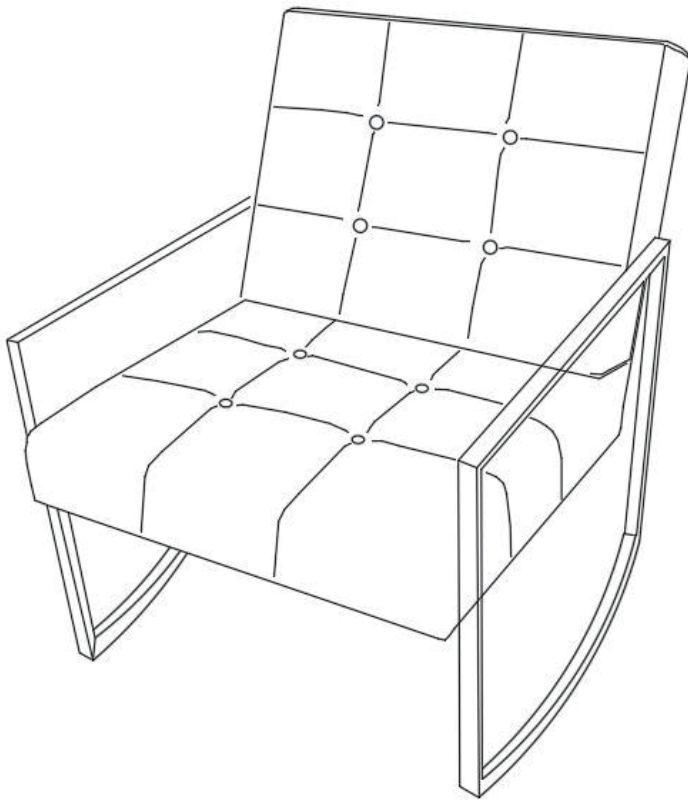
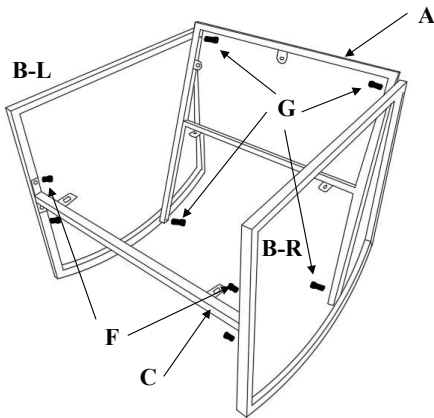

DO NOT OVER-TIGHTEN SCREWS UNTIL STEP 3 IS COMPLETE

**Step2**

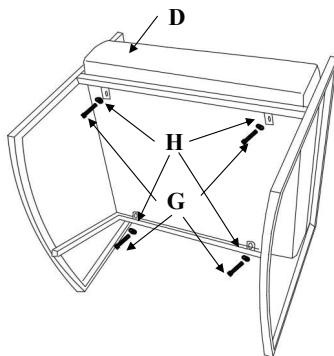

**Step3**

