

Takara Industry

DRY-WAVE®
TFG1209/0609

Designed for indoor use
Maximum load
8.0kg

Ceiling Mount Laundry Drying Rack



- This product is designed for indoor use. Do not use outdoor
- Do not use for other purposes except laundry drying

User's Manual

Thank you for purchasing "Indoor type laundry drying hanger"

TFG1209/0609. This product is designed for hanging laundry on the rod, with lifting up and down.

Please read this manual carefully, for your safety use.

① Parts Description



Please make sure the packing contents are complete, if not, contact the store you purchased or manufacturer.

Below symbols are indicated onto this manual.

- ⚠ Matters expected spreading damages
- ⊘ Prohibited actions ⊘ Disassembly is prohibited
- ❗ Please make sure to do
 - Please attach this manual even in case of hand over or lending to the 3rd person.
 - This manual contains warranty. Please store properly.
 - Please contact the store you purchased, or us for any inquiries on this product.

Product Dimensions

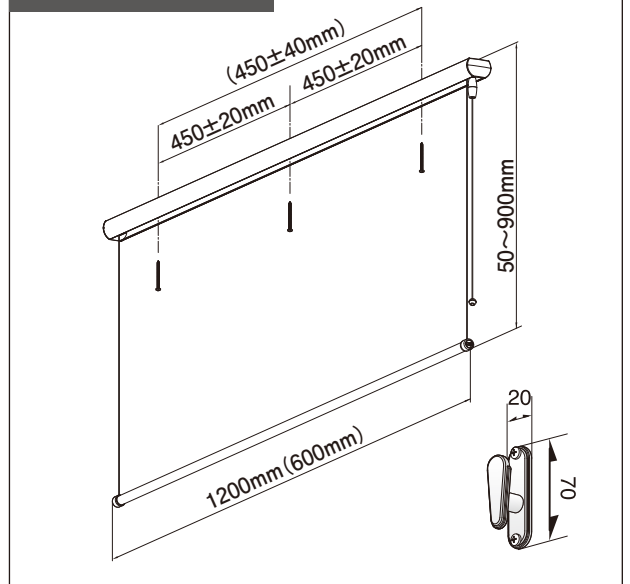

※Dimensions and numbers indicated are TFG1209. Dimensions and numbers of TFG0609 are given in (parenthesis).





■ Contents ■

① Parts Description	1
② Safety Precautions	2
③ Installing Instructions	
•Parts	2
•Preparation •How to install	3
④ How to use	4~5
⑤ Maintenance	5
⑥ Q&A	6
⑦ Product Specifications	6







② Attention for safety

● Please read this "Attention for safety" carefully, and use properly.

Warning May cause death or severe injury

Symbol	Important notice	Expected damages
	● Do not use for the purpose expect laundry drying.	May cause injury or product damage.
	● Do not install close to fire like cooking stove. Keep away from fire when hanging laundry.	May cause fire
	● Do not install at the place may obstacle any of ventilations of air-con, sensors of gas or fire alarms.	May cause fire, accident due to ventilatory insufficiency, or product damage.
	● Observe children not to bump into the product, or hang down from the rod.	May cause injury or product damage.

Caution May cause injury or product damage.

Symbol	Important notice	Expected damages
	● This product is designed for indoor use, do not use outdoor.	May cause product damage
	● Do not hang the laundry exceeded 8kg of maximum load.	May cause product damage.
	● Do not use when the cord wound around.	May cause product damage.
	● Do not pull strongly when the cord hooked up.	May cause injury or product damage.
	● Use all the screws to install properly, do not omit.	May cause injury or product damage.
	● Install the product horizontally on the ceiling, to secure the strength	May cause product damage.
	● Stop using the product when the body is not steady even after the screws are fastened.	May cause product damage.

③ How to install

■ Parts

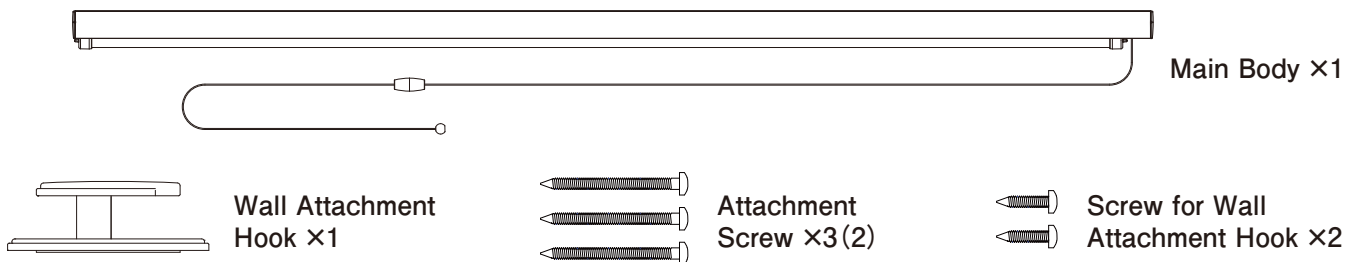

■ Installation Method on Each Skeleton Materials

■ Wooden Ceiling

Ceiling Attachment Screw 4×50

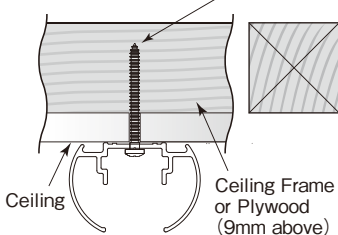

Caution

Please do not use Electric Screwdriver until completely tightened. Check the position, use the hand tool and finish the tightening.

■ Light Gauge Steel

Ceiling Attachment Screw 4×50

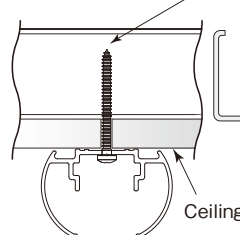

■ Concrete Ceiling

Anchor Plug (separately sold)

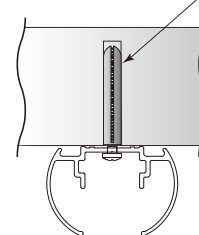

Caution

Please ask for advice by appropriate specialist if Light Gauge Steel or Concrete Ceiling are the materials to be installed.

③ How to install

■ Preparation

- Decide the right place to install, taking the operation cord or hung laundry would not obstruct the passage, or open/close of the door, into account.
- Use the stepladder, work safely and with relaxed position.
- Prepare Phillips Screwdriver, and gimlet for prepared hole.

■ How to install

1. Use the frame sensor and find out the frame location.

- 1) Check the frame location.
- 2) Decide the installing position with using frame sensor.



Frame location must be checked with frame sensor.

2. Check the screw hole position of the main body, mark the hole position on the ceiling.

3. Drill the prepared hole approx. 10mm depth.

- ※ To avoid the idle rotation of the screw, do not make big hole.
- ※ Screw hole should be drilled vertically to the wall surface.



Wear the safety goggles is recommended to prevent sawdust get into the eyes.

4. Tighten the screw, with 3mm~5mm remained until completely tightened.

5. Set the main body to the screws, slide the body to left or right.

(To make the main body and screws to be symmetric.)

6. 3 pieces (2 pieces) of screws to be tightened in turns, with same pressure.

7. Hold both end of main body, and check the sufficient stability is secured. Installation is completed.

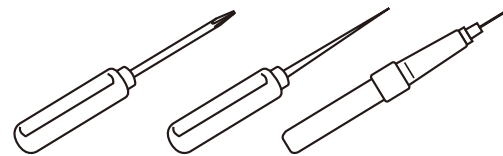

Phillips Screwdriver Gimlet Frame Sensor

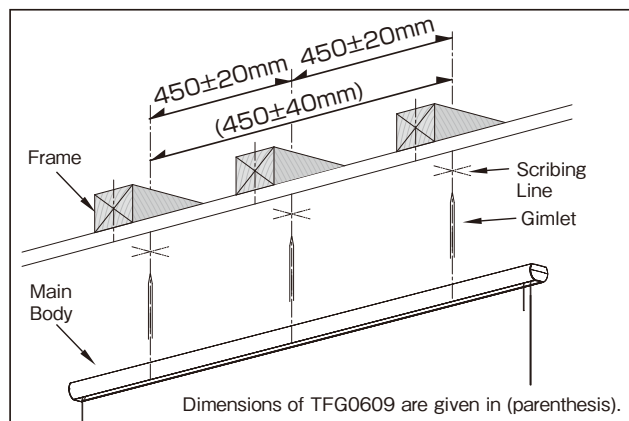

Drill the prepared hole



Tighten the screw with 3mm~5mm remained until completely tightened.

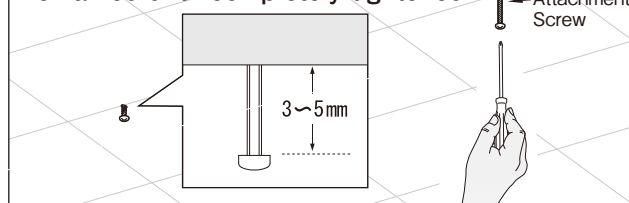

Set the main body

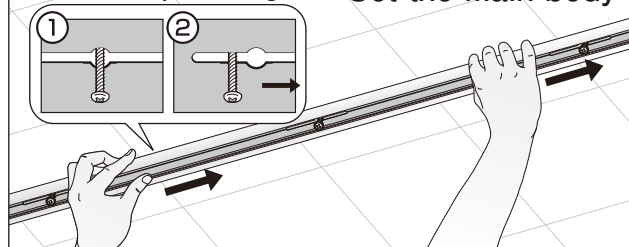

Tighten the screws

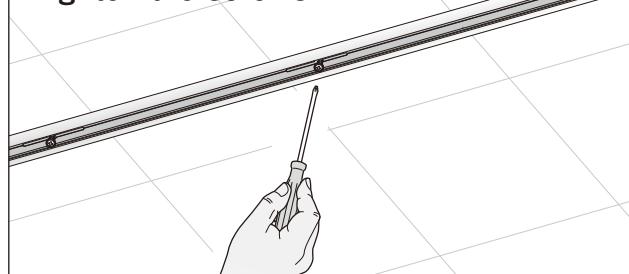

4 How to use



Caution May cause injury or product damage

Symbol	Important notice	Expected damages
	● Do not disassembly the height adjuster	May cause product damage



- If you find unstable of the product position due to loosen screw, tighten again. Or make other prepare hole and re-install at another position.
- If installed location is close to the window, retract the rod and do not use when the strong wind.
- Height adjustment when nothing hung on the rod.

1. Refer to the right side illustration, adjust the height at the desired position.

- 1) Pull down the operation cord to inside direction, hanging cord is unlocked.
- 2) When pull and release the operation cord, rod will be lifted up and down.
- 3) Adjust at the desired position.
- 4) Hanging cord will be locked when operation cord released a little to the outside direction.

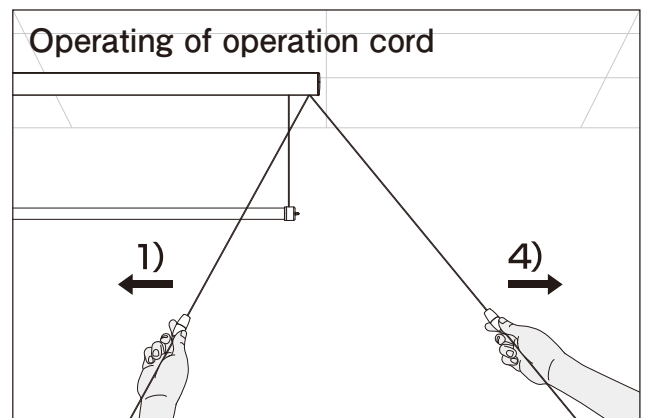

2. Hang the laundry equally on the rod.



Caution May cause injury or product damage

Symbol	Important notice	Expected damages
	● Do not move the operation cord with hanging the laundry on the rod.	May cause product damage
	● Do not hang the laundry exceeded 8kg weight.	May cause injury or product damage

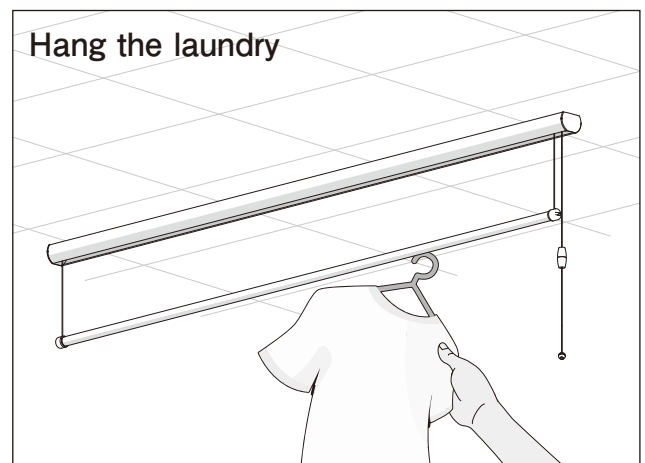

3. Retract the rod to avoid obstructing the way, after use.

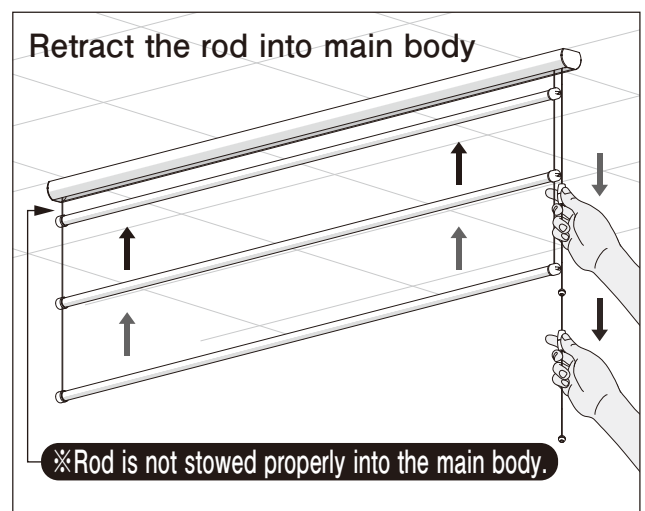

4 How to use

How to stow the operation cord



● Operation cord should be stowed with using cord stopper cap or wall attachment hook.

Stow with stopper cap

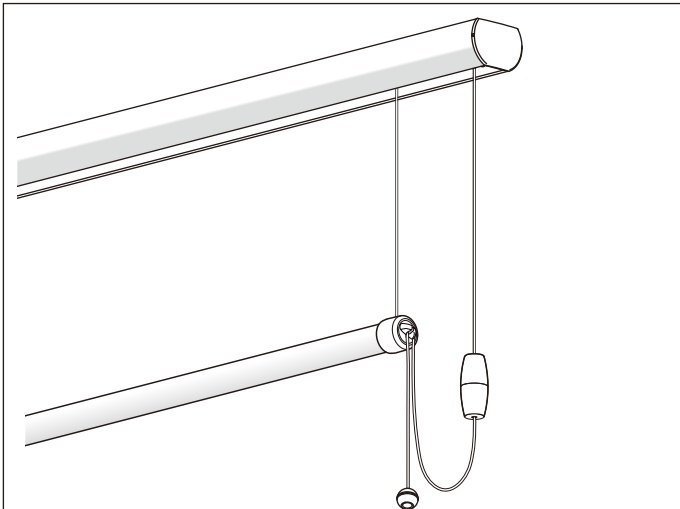

Insert loosen operation cord into stopper cap, then stow at higher place.

Stow with wall attachment hook

1. Attach the wall attachment hook on the wall, with screws.

※ Recommended location for installation is the frame of sliding door, etc.

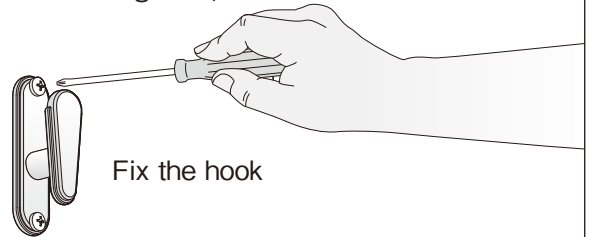

Fix the hook

2. Wind the loosen cord around the hook and stow.

Wind the cord around the hook

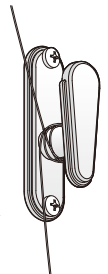

5 Maintenance



Caution May cause injury or product damage

Symbol	Important notice	Expected damages
	● Check the stability of product installation at times.	May cause injury or product damage.
	● When clean up the product, do not use cleaning agent which contains thinner, benzine, alcohol, or organic solvent.	May cause melting of product surface, deterioration or deformation of product.
	● Do not use brush with hard bristle.	May cause product damage.
	● Check frayed part or damages on hanging cord and operation cord, stop using if any problems.	May cause injury or product damage.

1. Wipe off the dirt with tightly wrung soft cloth.
2. Use diluted neutral detergent for tough stains.
3. Remove the dust when accumulated at the roller part.

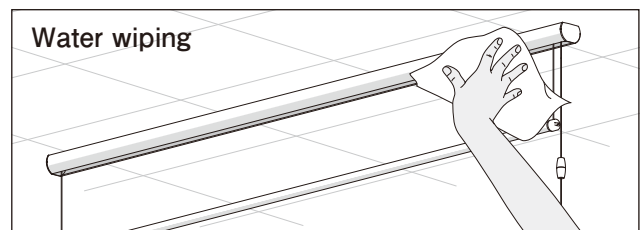

Water wiping

Please do not use the following stuffs for cleaning



- × Cleaning agent of Acid or Alkaline (for Toilet or House cleaning)
- × Bleaching agent
- × Organic solvent like thinner
- × Hard bristles like brush

Diluted neutral detergent



Wiping with dry cloth

Wipe up the water properly with soft cloth



⑥ Q&A

Q.Rod movement is not smooth.

A. Any frays or damages on hanging cord?

Please set straight the cord and try again.

A. Any dust caught at roller part? Please remove if any, and try again.

Q.Main body is unstable fixed.

A. Screws are loose?

Tighten the screw again. If any problem with the installation position, try to change it.

Q. Rod is unbalanced.

A. Loosen the rope in the “height adjuster” and adjust the position.

(Product must be removed from the ceiling before adjustment)

⑦ Standard specification

Product Name: Indoor Type Laundry Drying Hanger

Model No. : TFG1209 (TFG0609)

Usage: Laundry drying indoor

Materials: Aluminum Alloy, Stainless, Polycarbonate

Dimensions: Main Body/Total Length 1247 (647)mm, Maximum Lift Down up to 900mm

Product Weight: Approx. 1120g (600g)

Country of Origin: China



TAKARA INDUSTRY CO.,LTD.
タカラ産業株式会社

2-2-30 Nagata Eminence Bld. 2F,
Nagata Naka,Higashi Osaka-City,Osaka,
577-0013, Japan
TEL: +81-6-7711-3080
<https://www.takaranet.co.jp/eng/>