

Tips!

Check all the components & screws before assembly. **Do not install in case part is missing, contact us to get.** Send email with your question to support@vecelo.com. We will resend within 24 hours.

Return Policy

We believe you will absolutely love your new item. But if for some reason you want to return, please contact us directly before you decide to return your product. Our customer service organization can answer most concerns and assist you with any questions you may have about your new item, please email us first at: support@vecelo.com. The item must be returned within 30 days of delivery for a full refund. The item must be returned in good condition, in original box, with all original proof of purchase, parts and accessories.

Trouble shooting:

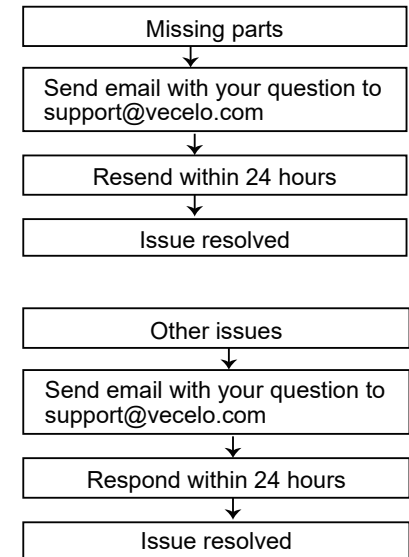

We control manufacturing and distribution ourselves, ensure the quality.

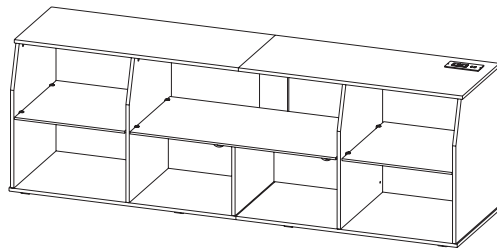

TV Stand

Dimension: 140*40*52cm
160*40*52cm
180*40*52cm

How to find us?

Email: support@vecelo.com

Website: www.vecelo.com

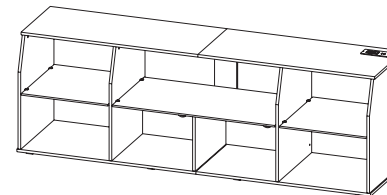

Item Description: TV Stand
 Dimension: 140*40*52cm
160*40*52cm
180*40*52cm
 Model NO: JYX-NO.1

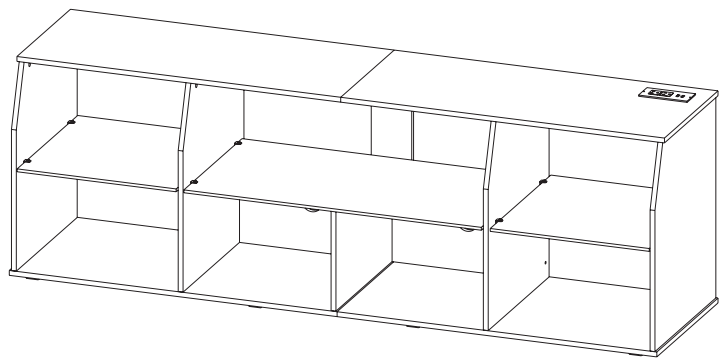
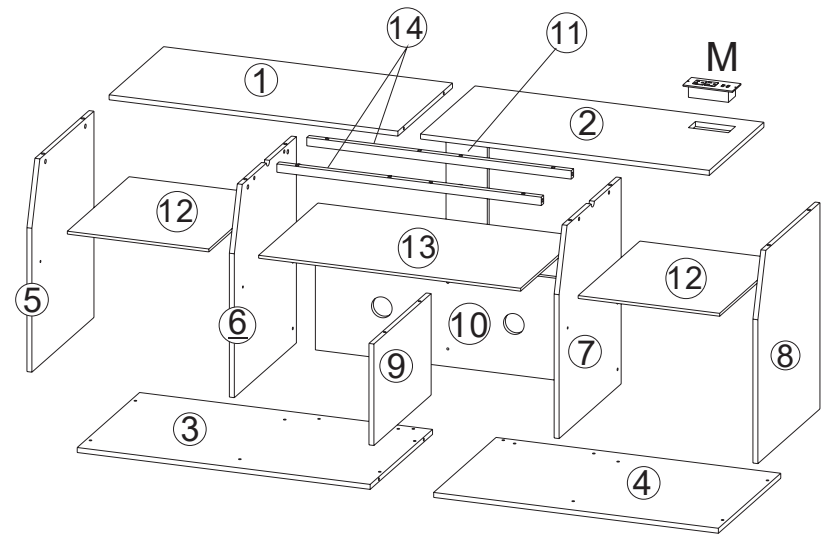

Step 12

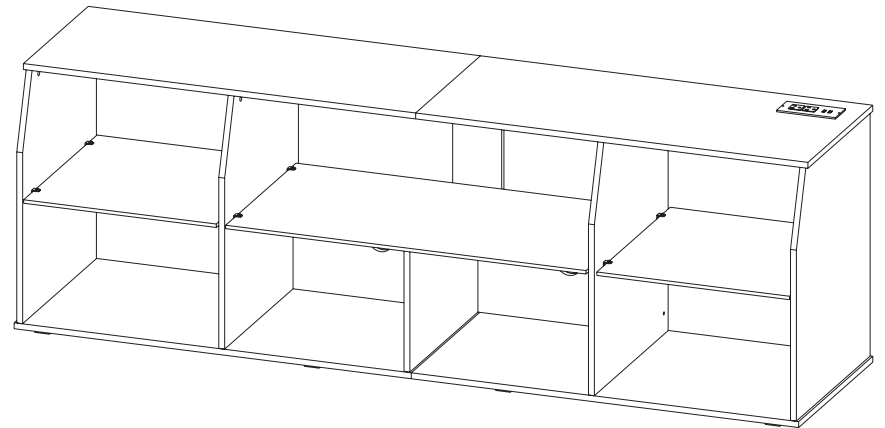



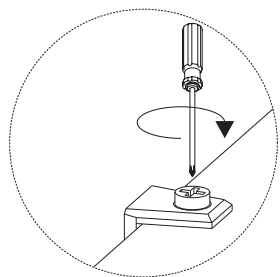
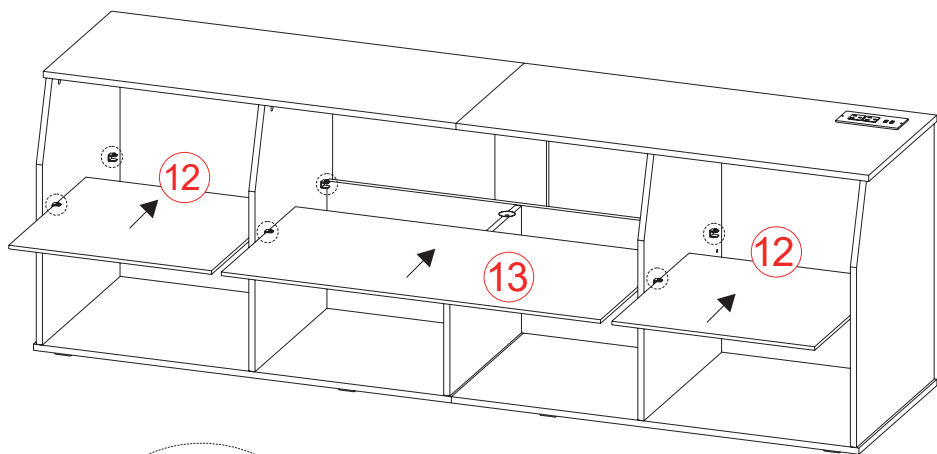





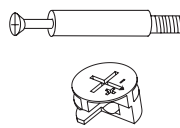



Step 11

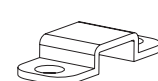

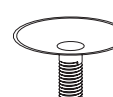
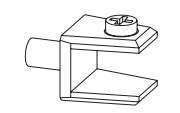

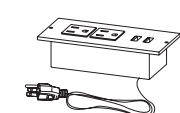
Fasten the screws after installing part 12/13

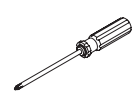
Components					
1		1pcs	2		1pcs
3		1pcs	4		1pcs
5		1pcs	6		1pcs
7		1pcs	8		1pcs
9		1pcs	10		1pcs
11		1pcs	12		2pcs
13		1pcs	14		2pcs



A		10pcs	B	 M6x25	12pcs
C	 ST5x40	22pcs	D	 Φ6x30mm	4pcs
E		2pcs	F	 ST3.5x12	10pcs
G	 ST3x12	12pcs	H		6pcs
I		1pcs	J		2pcs
K		12pcs	L		8pcs
M		1pcs			
		1pcs			1pcs

Step 10

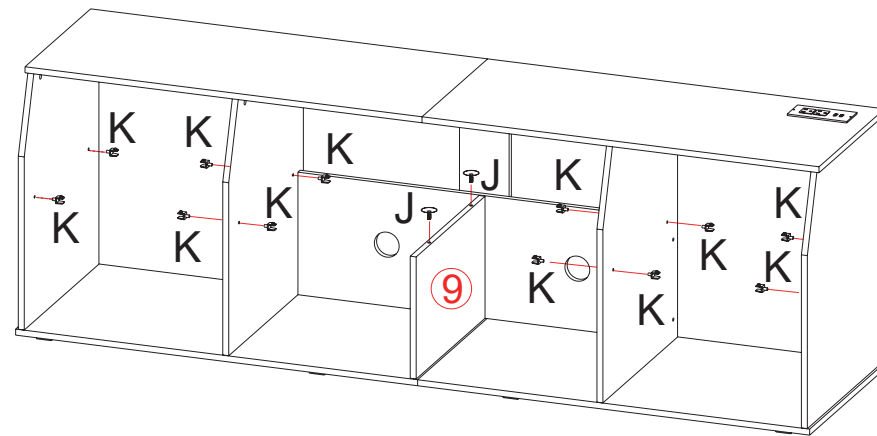
	Jx2
	Kx12



Step 9

	Cx2		Mx1
	Fx2		

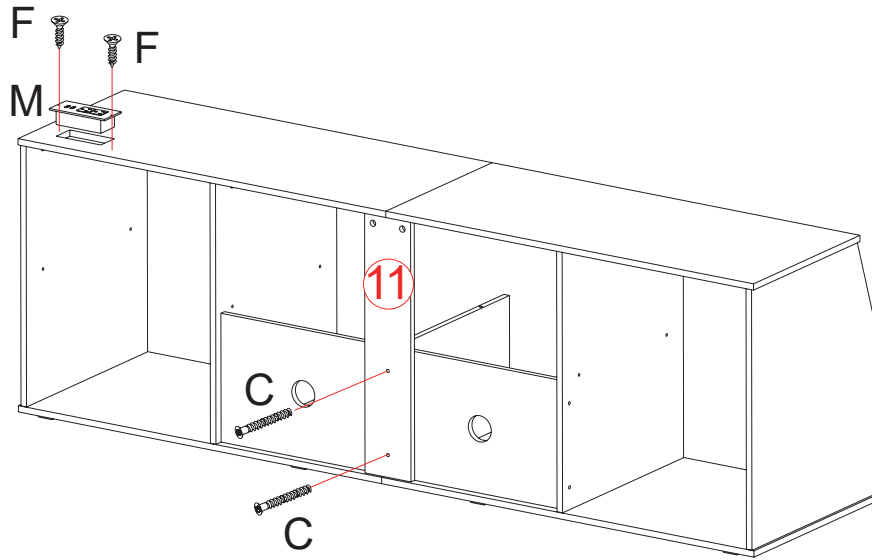

"A" Hardware
installation example

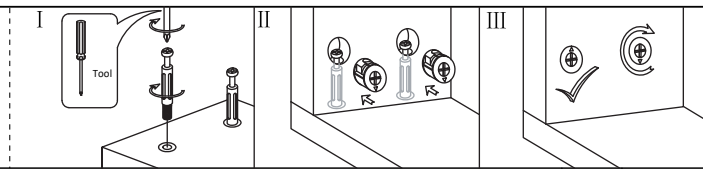

Step 1

	Dx2
---	-----

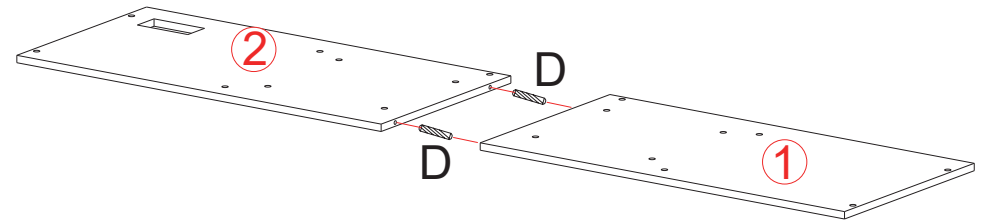

Step 2

 Bx8

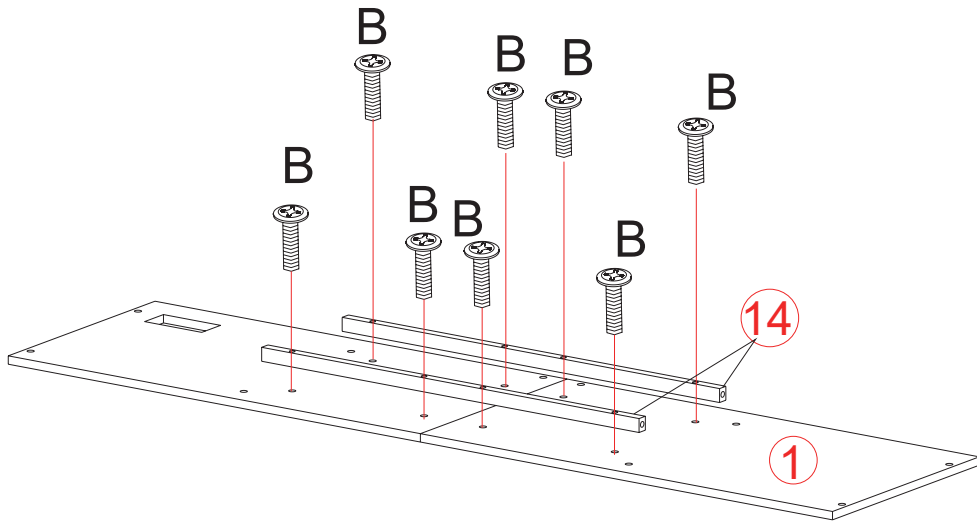

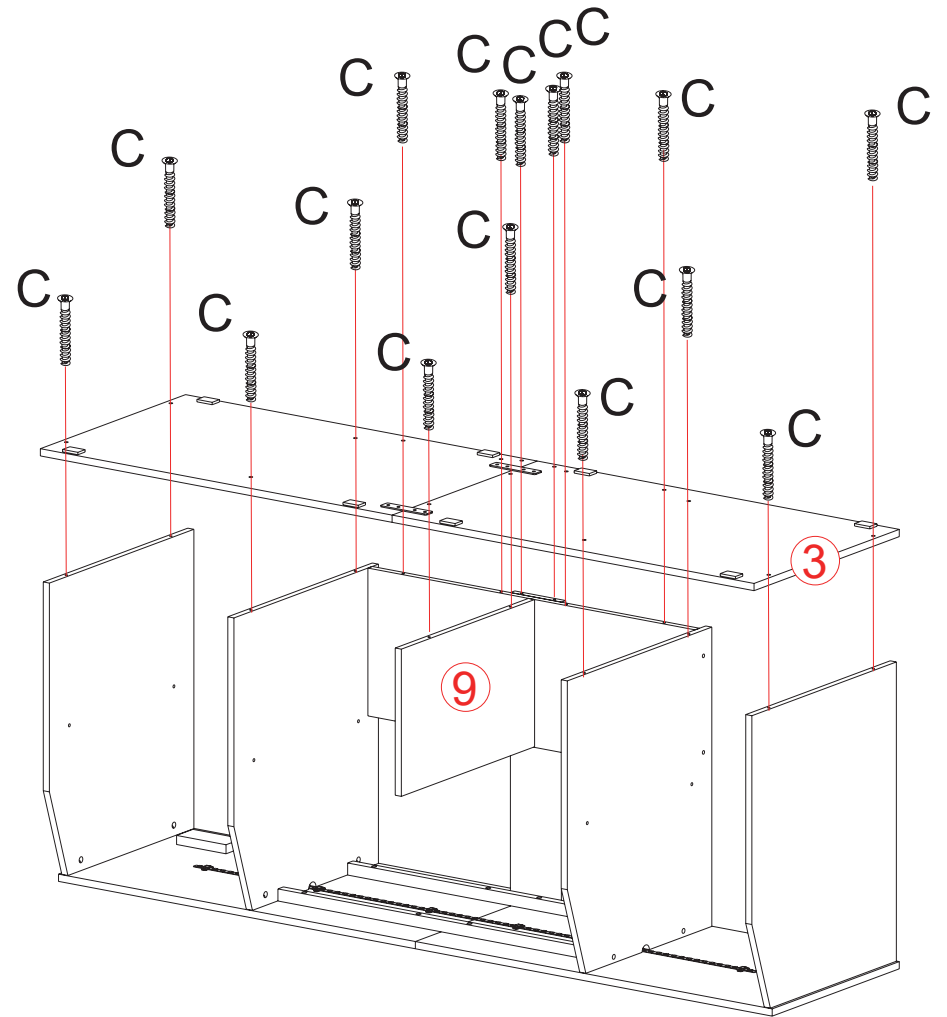

Step 8

 Cx16



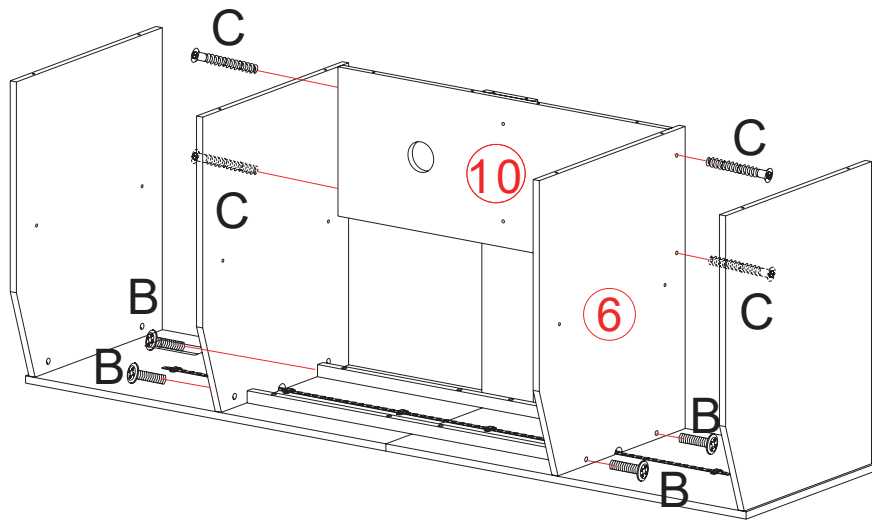

Step 7

	Cx4
	Bx4



Step 3

	Gx12		Hx6
			Ix1

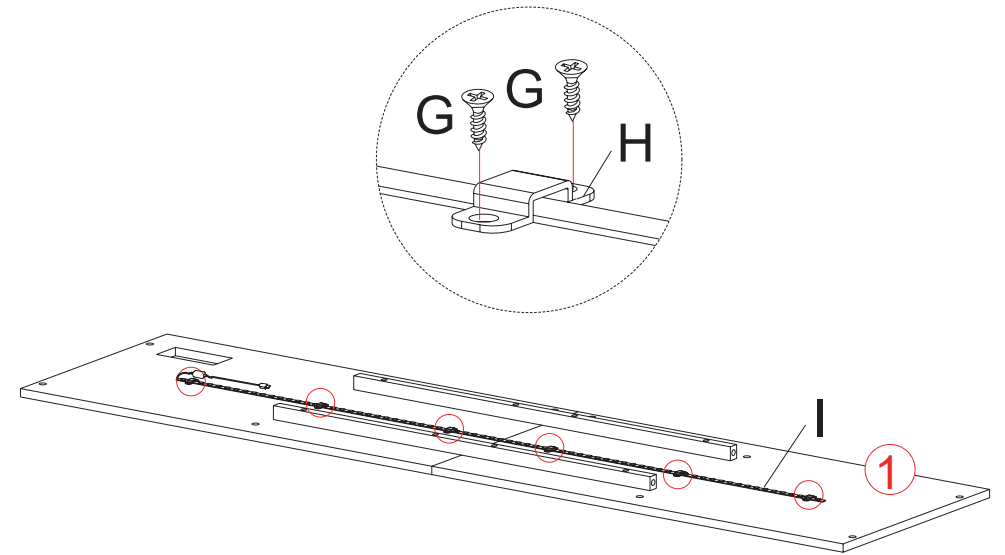



Screw H can secure the light band to any position you like

Step 4

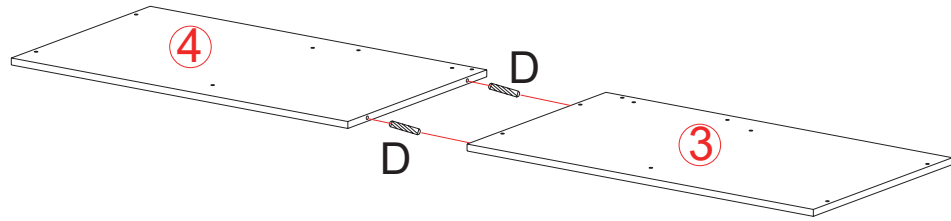
 Dx2



Step 5

 Ex2  Fx8
 Lx8

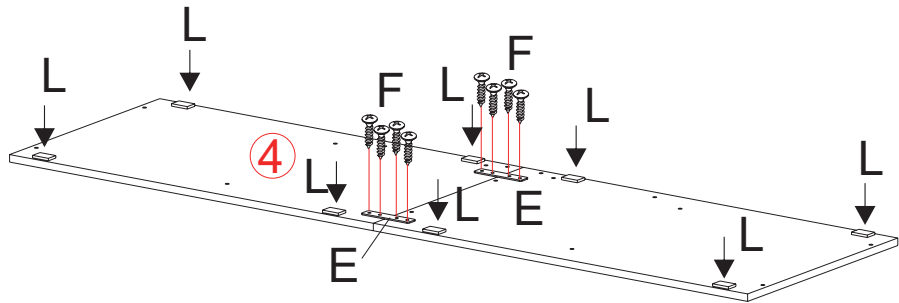

Step 6

 Ax10

