

ASSEMBLY INSTRUCTIONS

SKU CODE: N709P215545

INSTRUCTIONS DE MONTAGE

SKU CODE: N709P215545

HOUSE BED

LIT MAISON

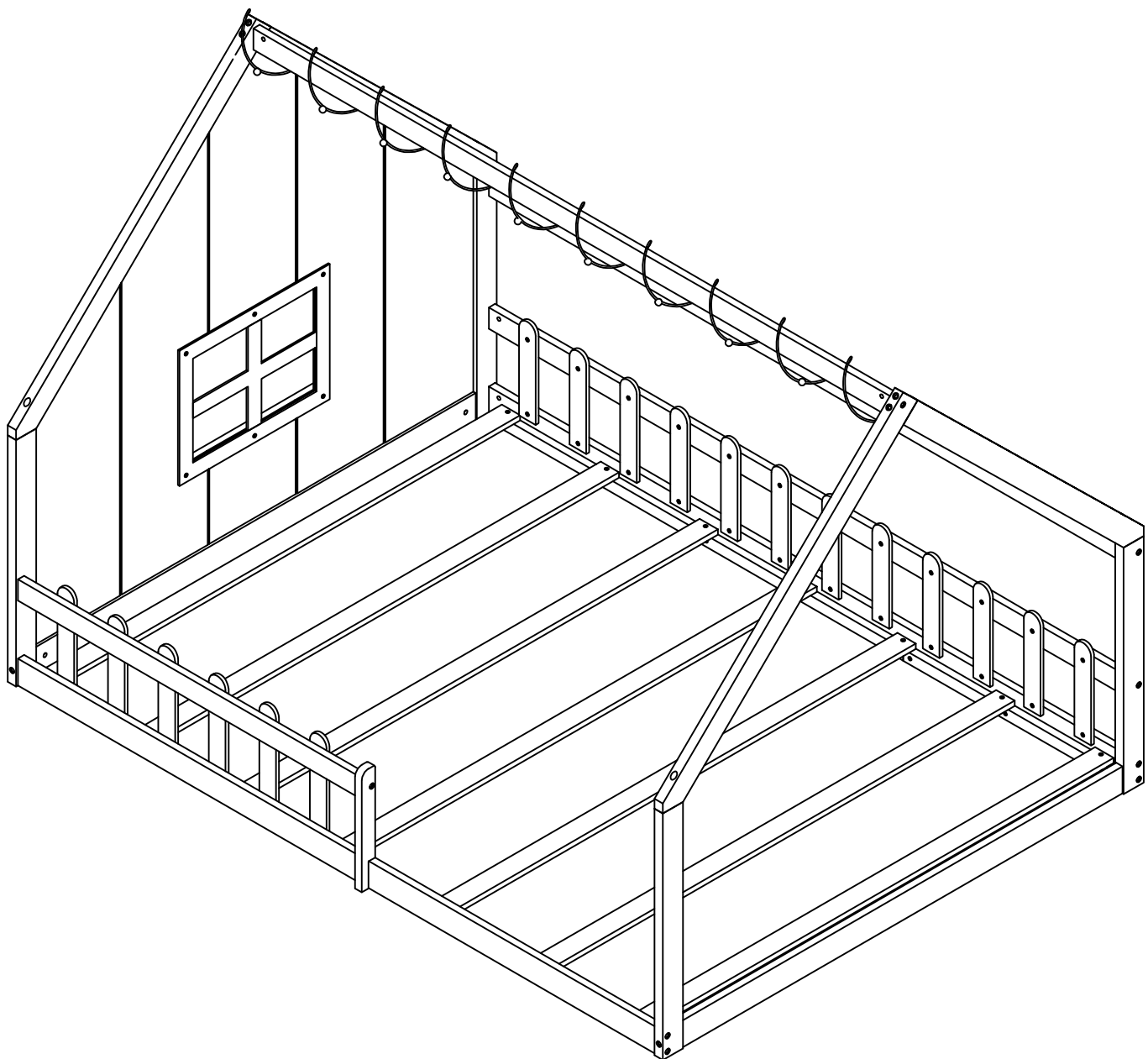



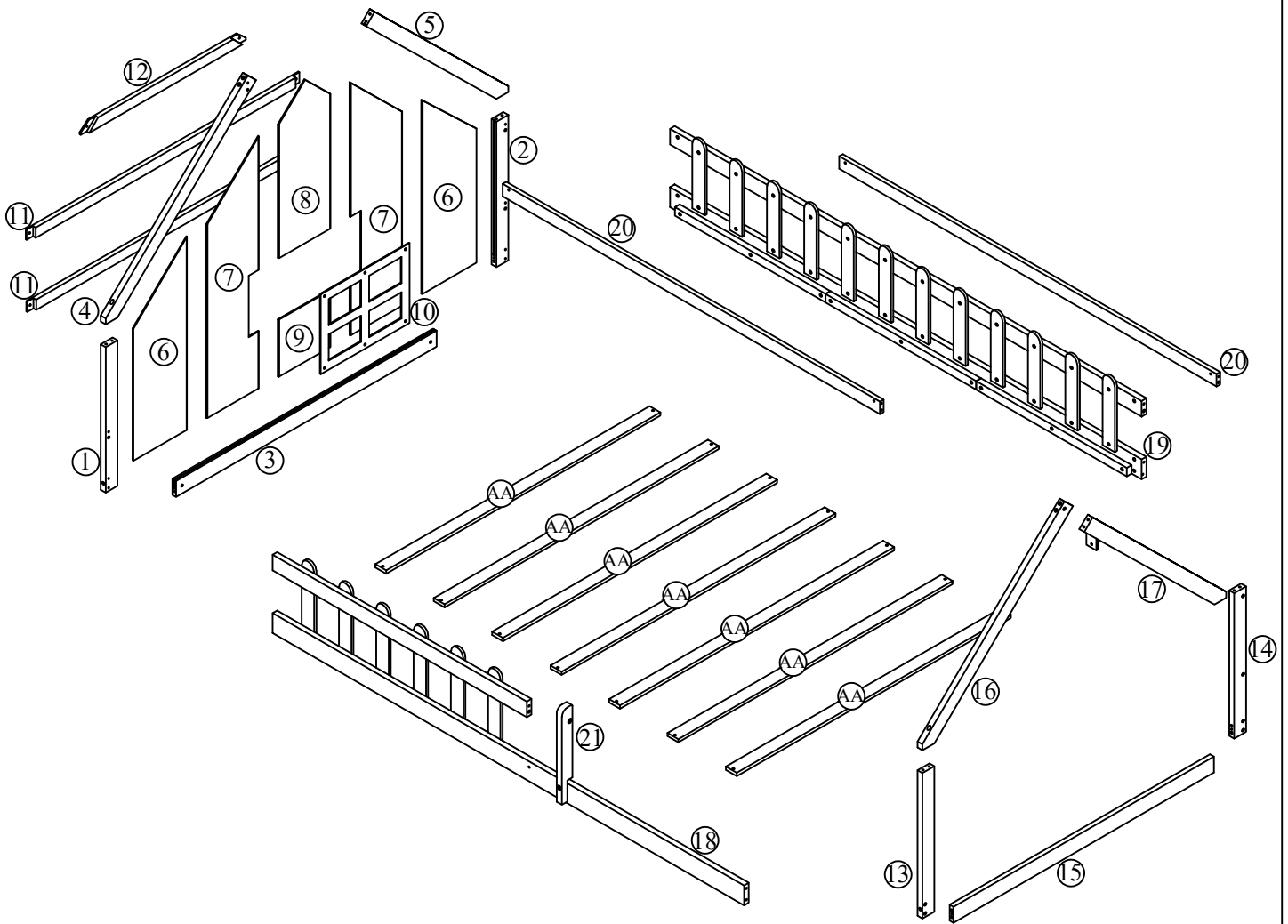





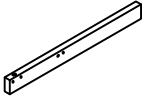
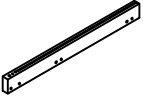

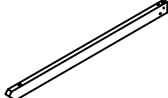
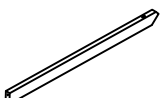
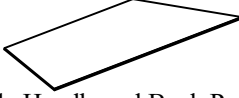
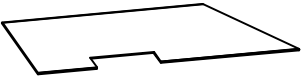

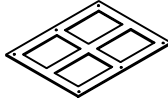
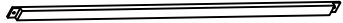

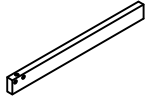
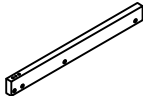
Detail View
(Vue détaillée)







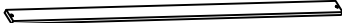

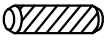

Part List :

(Liste des pièces)

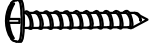
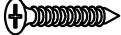
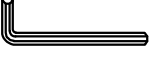
<p>1</p>  <p>Left Headboard Leg-1pc Pied de tête gauche-1pc</p>	<p>2</p>  <p>Right Headboard Leg-1pc Pied de tête droit-1pc</p>	<p>3</p>  <p>Bed Headboard-1pc Tête de lit-1pc</p>
<p>4</p>  <p>Left Cross Brace Headboard-1pc Tête de lit à croisillons gauche-1pc</p>	<p>5</p>  <p>Right Cross Brace Headboard -1pc Tête de lit à croisillons droits-1pc</p>	<p>6</p>  <p>Outside Headboard Back Panel-2pcs Panneau arrière de la tête de lit extérieure-2pcs</p>
<p>7</p>  <p>Middle Headboard Back Panel-2pcs Panneau arrière de la tête de lit centrale-2pcs</p>	<p>8</p>  <p>Above Headboard Back Panel-1pc Au-dessus du panneau arrière de la tête de lit-1pc</p>	<p>9</p>  <p>Below Headboard Back Panel -1pc Sous le panneau arrière de la tête de lit -1pc</p>
<p>10</p>  <p>Window-1pc Fenêtre-1pc</p>	<p>11</p>  <p>Lower Horizontal Bar-2pcs Barre horizontale inférieure-2pcs</p>	<p>12</p>  <p>Upper Horizontal Bar-1pc Barre horizontale supérieure-1pc</p>
<p>13</p>  <p>Left Footboard Leg-1pc Pied de lit gauche-1pc</p>	<p>14</p>  <p>Right Footboard Leg-1pc Pied de lit droit-1pc</p>	<p>15</p>  <p>Bed Footboard-1pc Pied de lit-1pc</p>
<p>16</p>  <p>Left Cross Brace Footboard-1pc Traverse gauche pour marchepied-1pc</p>	<p>17</p>  <p>Right Cross Brace Footboard -1pc Traverse de marchepied droite-1pc</p>	<p>18</p>  <p>Left Side Rail -1pc Rail latéral gauche - 1pc</p>
<p>19</p>  <p>Right Side Rail-1pc Rail latéral droit-1pc</p>	<p>20</p>  <p>Rear Safety Railing -2pcs Garde-corps de sécurité arrière - 2pcs</p>	<p>21</p>  <p>Support Bar -1pc Barre de soutien - 1pc</p>
<p>AA</p>  <p>Slat-7pcs Lattes-7pcs</p>		

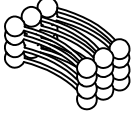
Hardware List (Liste du matériel)

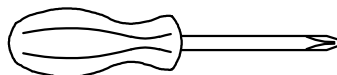

<p>A</p>  <p style="text-align: center;"> $\text{\O}10 \times 30\text{mm}$ Wood dowel =20pcs Cheville en bois =20pcs </p>	<p>B</p>  <p style="text-align: center;"> $\text{\O}1/4" \times 100\text{mm}$ Bolt=4pcs Boulon =4pcs </p>	<p>C</p>  <p style="text-align: center;"> $\text{\O}1/4" \times 70\text{mm}$ Bolt=24pcs Boulon =24pcs </p>
<p>D</p>  <p style="text-align: center;"> $\text{\O}1/4" \times 25\text{mm}$ Bolt=7pcs Boulon =7pcs </p>	<p>E</p>  <p style="text-align: center;"> $\text{\O}1/4" \times \text{\O}10 \times 12\text{mm}$ Cross nut =20pcs Écrou à embout flottant =20pcs </p>	<p>F</p>  <p style="text-align: center;"> $\text{\O}4 \times 20\text{mm}$ Round Head Screw =6pcs Vis à tête ronde=6pcs </p>
<p>G</p>  <p style="text-align: center;"> $\text{\O}4 \times 25\text{mm}$ Screw=14pcs Vis=14pcs </p>	<p>H</p>  <p style="text-align: center;"> K4mm Allen key (1pc) Clé Allen=1pc </p>	<p>I</p>  <p style="text-align: center;"> $\text{\O}3 \times 15\text{mm}$ Round Head Screw =5pcs Vis à tête ronde=5pcs </p>
<p>J</p>  <p style="text-align: center;"> Led lights (1pc) </p>	<p>K</p>  <p style="text-align: center;"> Plastic Button (5pcs) Bouton en plastique (5pcs) </p>	

ASSEMBLY TOOLS REQUIRED (NOT INCLUDED) OUTILS D'ASSEMBLAGE REQUIS (NON INCLUS)



PLEASE BE CAREFUL DO NOT DAMAGE THE HOLE POSITION WHEN YOU USE POWER TOOLS !
(FAITES ATTENTION À NE PAS ENDOMMAGER LA POSITION DU TROU LORSQUE VOUS UTILISEZ DES OUTILS ÉLECTRIQUES !)

STEP 1:
(ÉTAPE 1)

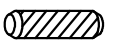
H 	E  2PCS	B  2PCS	A  4PCS
--	---	---	---

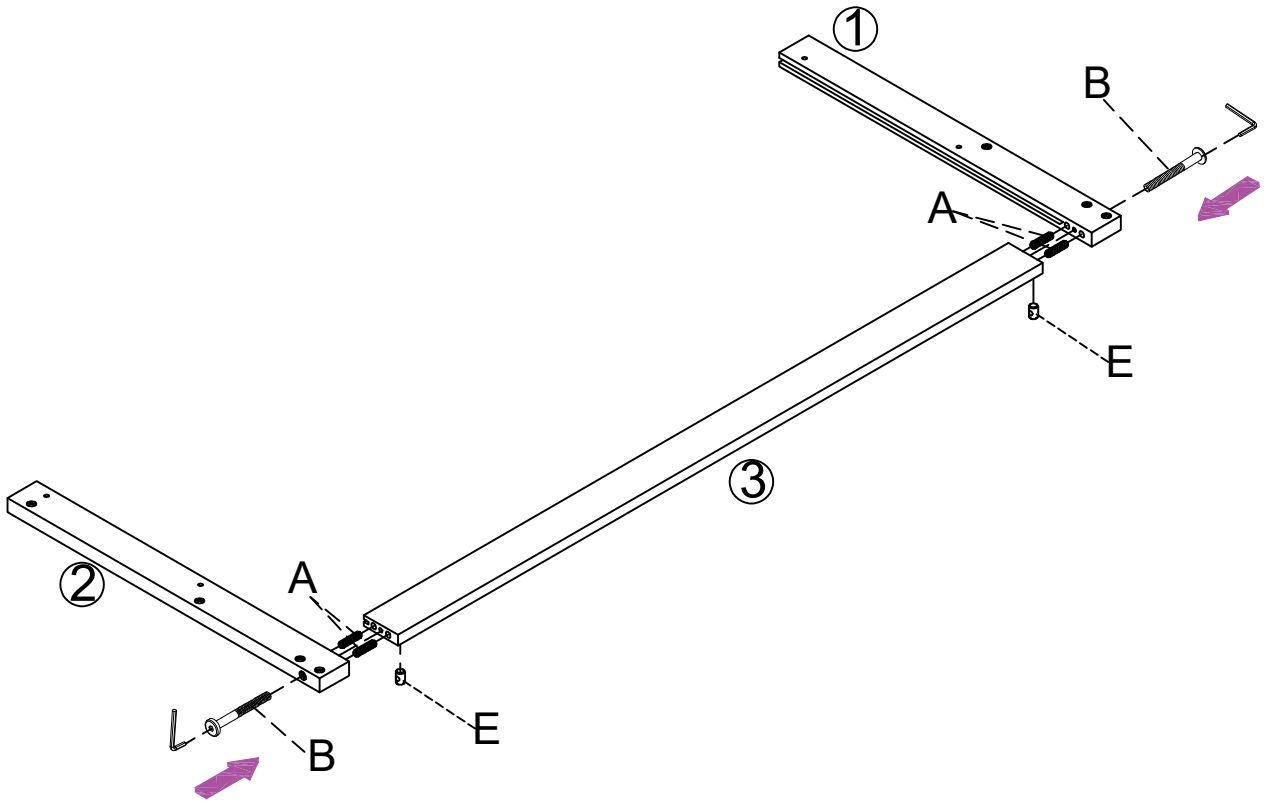

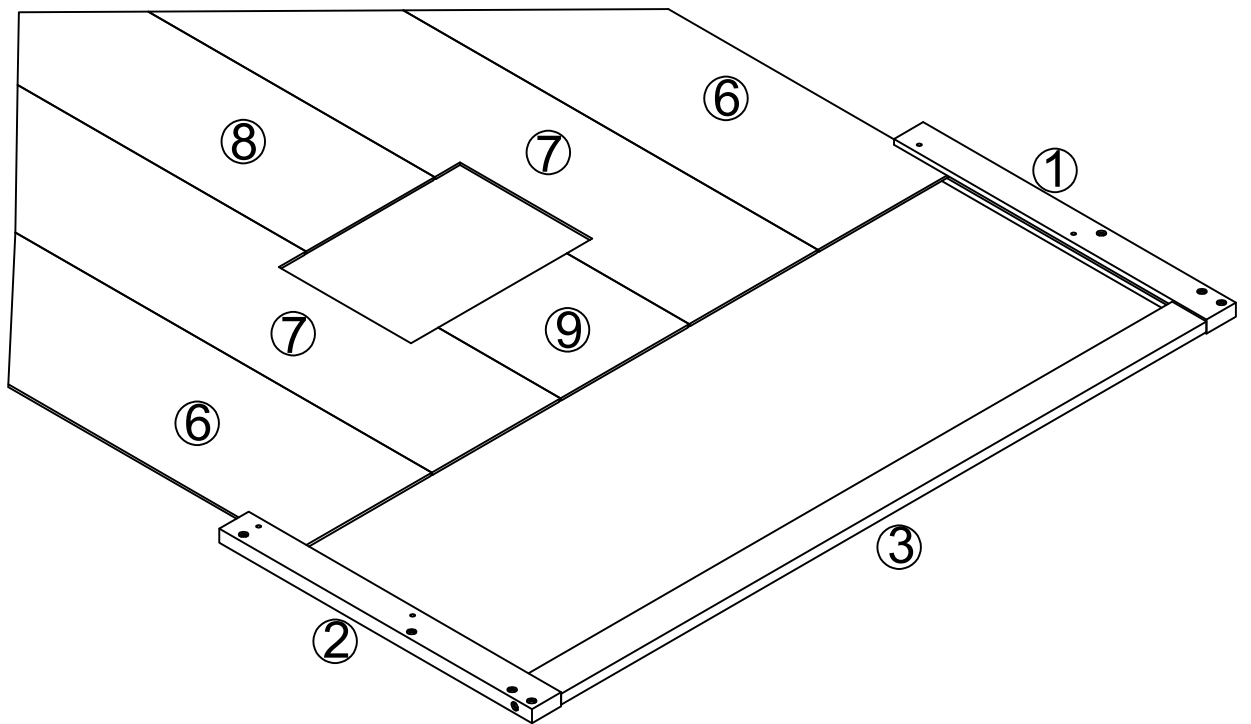

STEP 2:
(ÉTAPE 2)

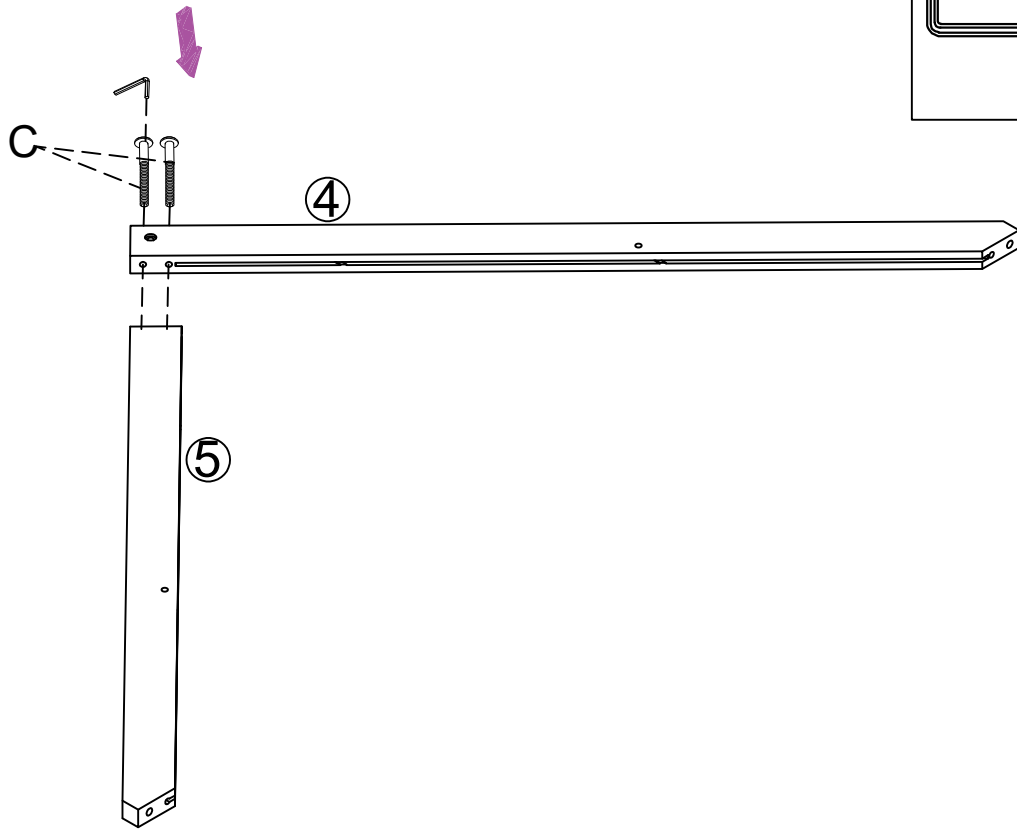

STEP 3:

(ÉTAPE 3)





H	C
	
2PCS	

STEP 4:

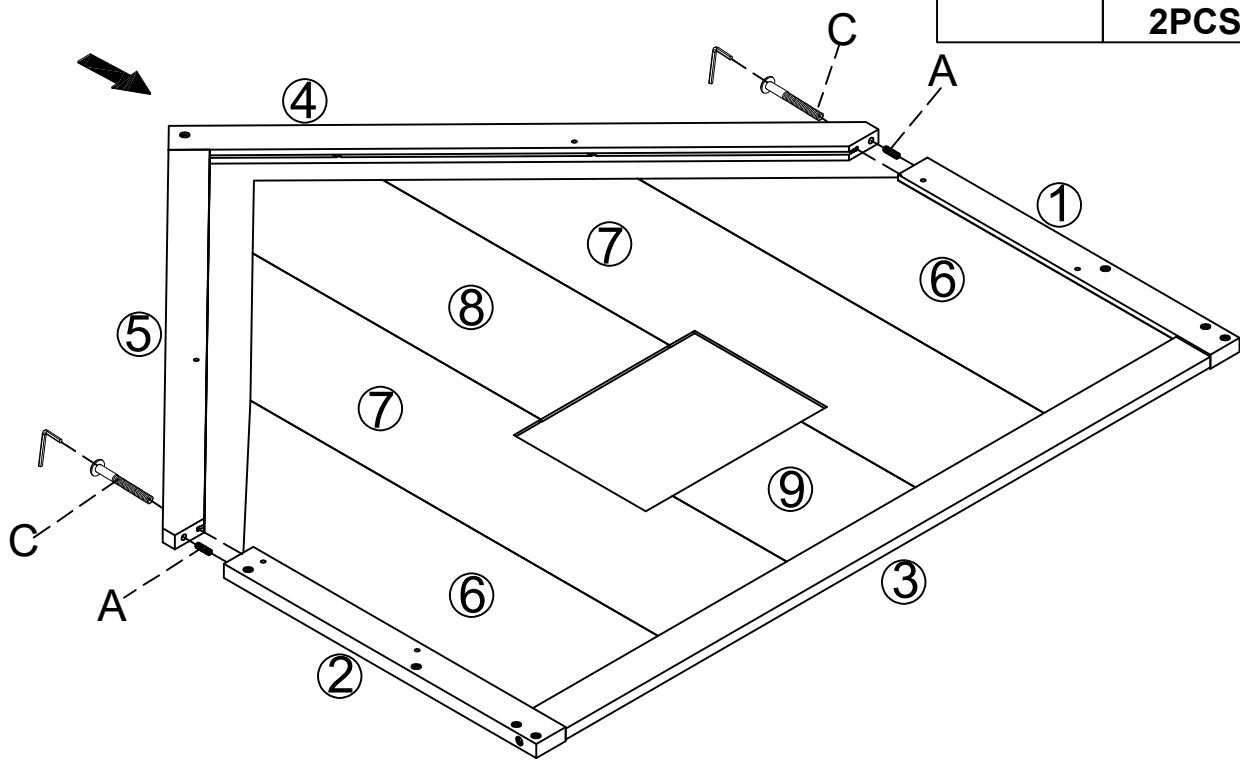
(ÉTAPE 4)



H	C	A
		
2PCS		2PCS

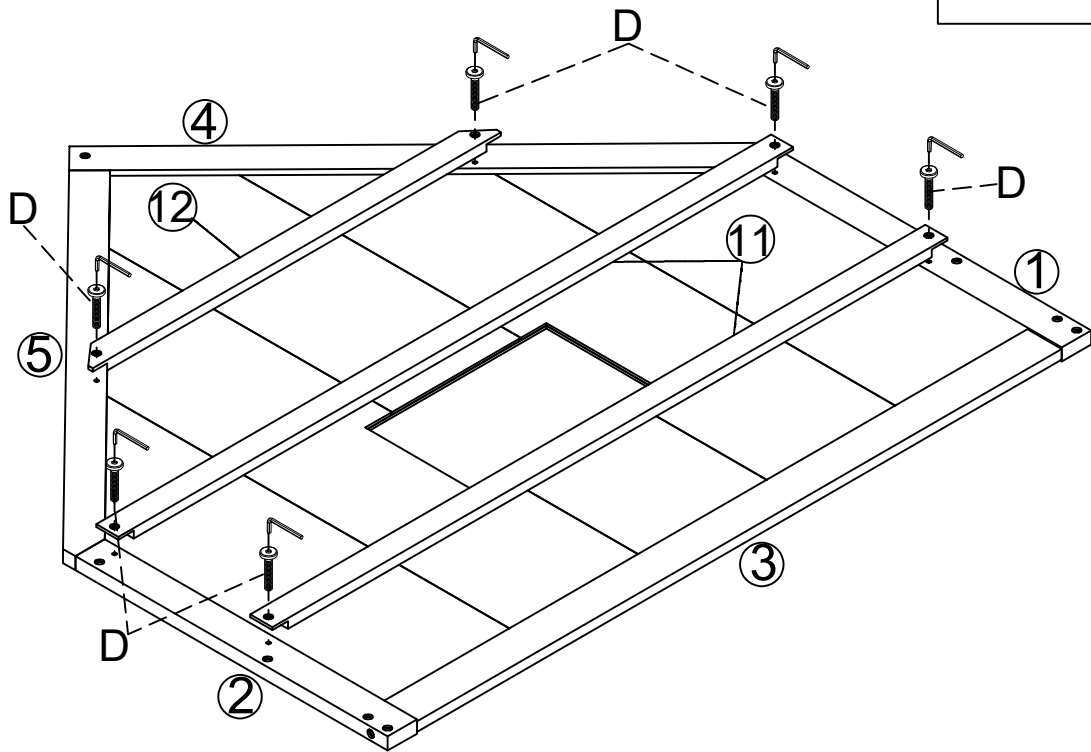
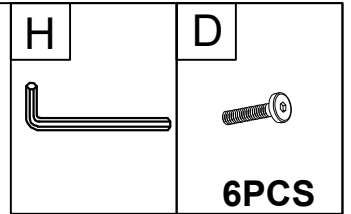

STEP 5:
(ÉTAPE 5)

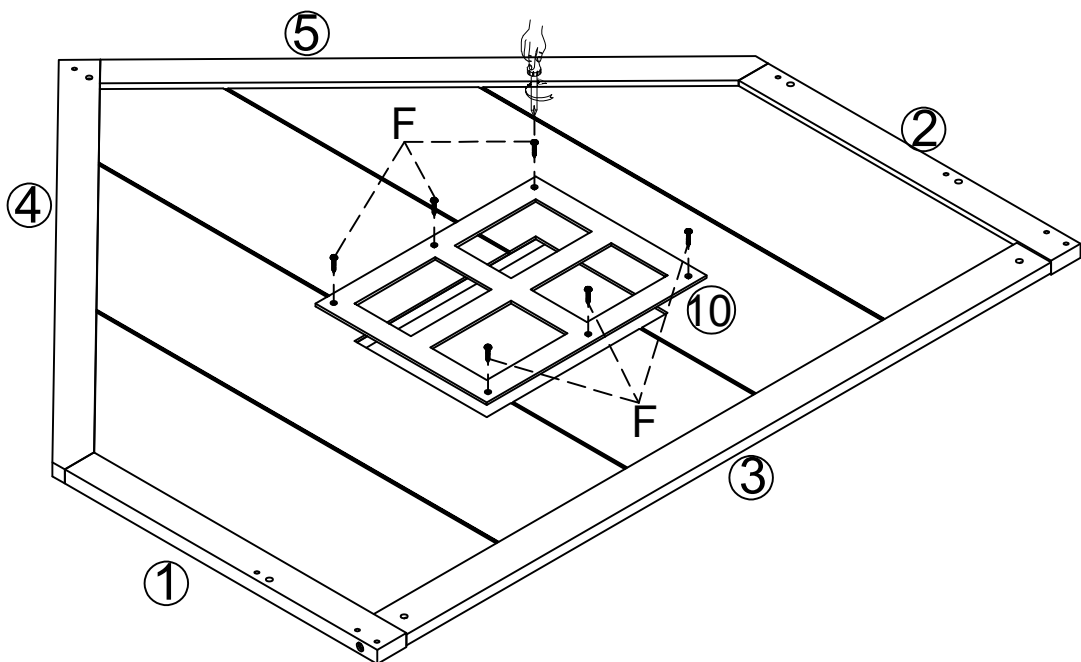
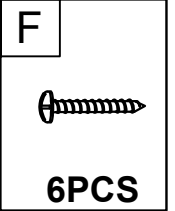

STEP 6:
(ÉTAPE 6)



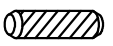

STEP 7:
(ÉTAPE 7)

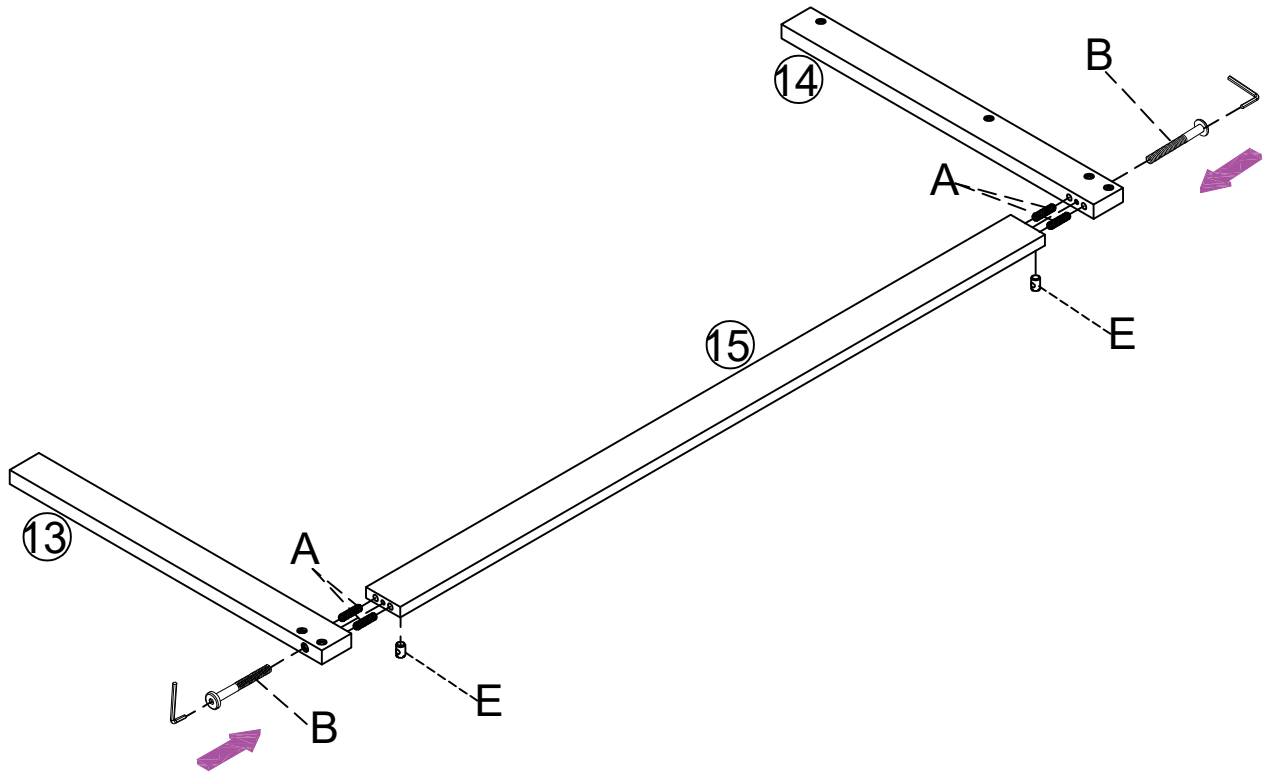
H 	E 	B 	A 
	2PCS	2PCS	4PCS



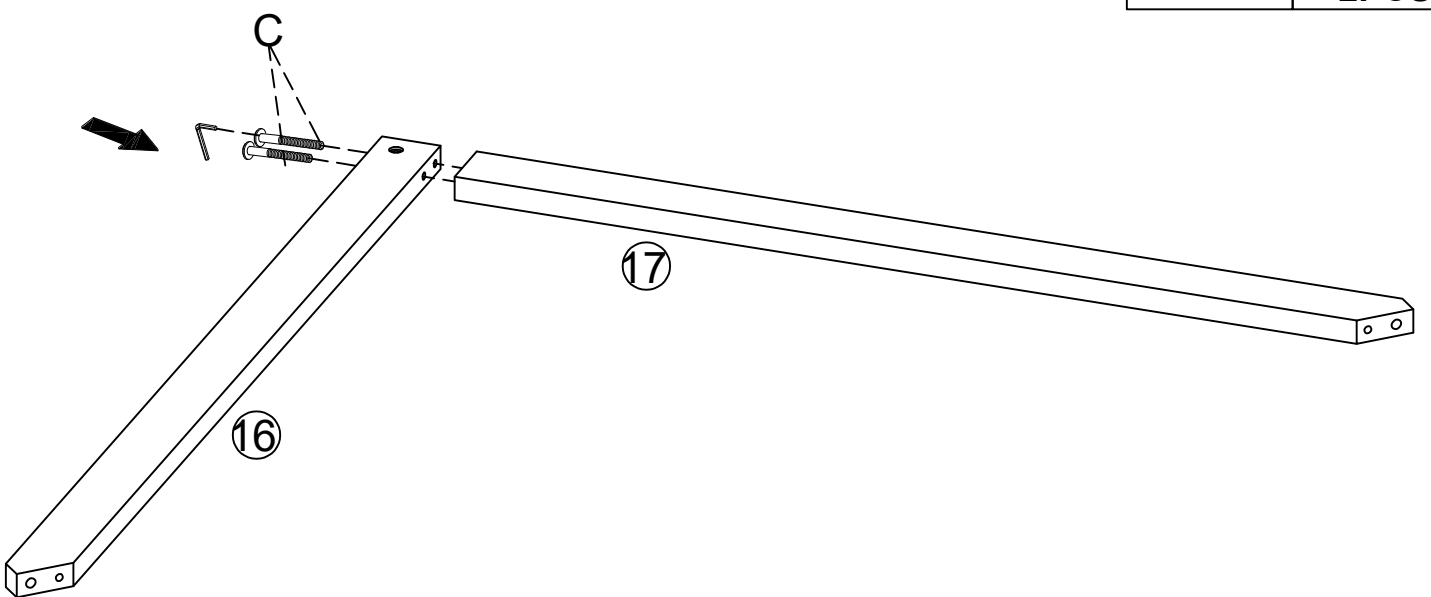

STEP 8:
(ÉTAPE 8)

H 	C 
	2PCS





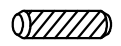

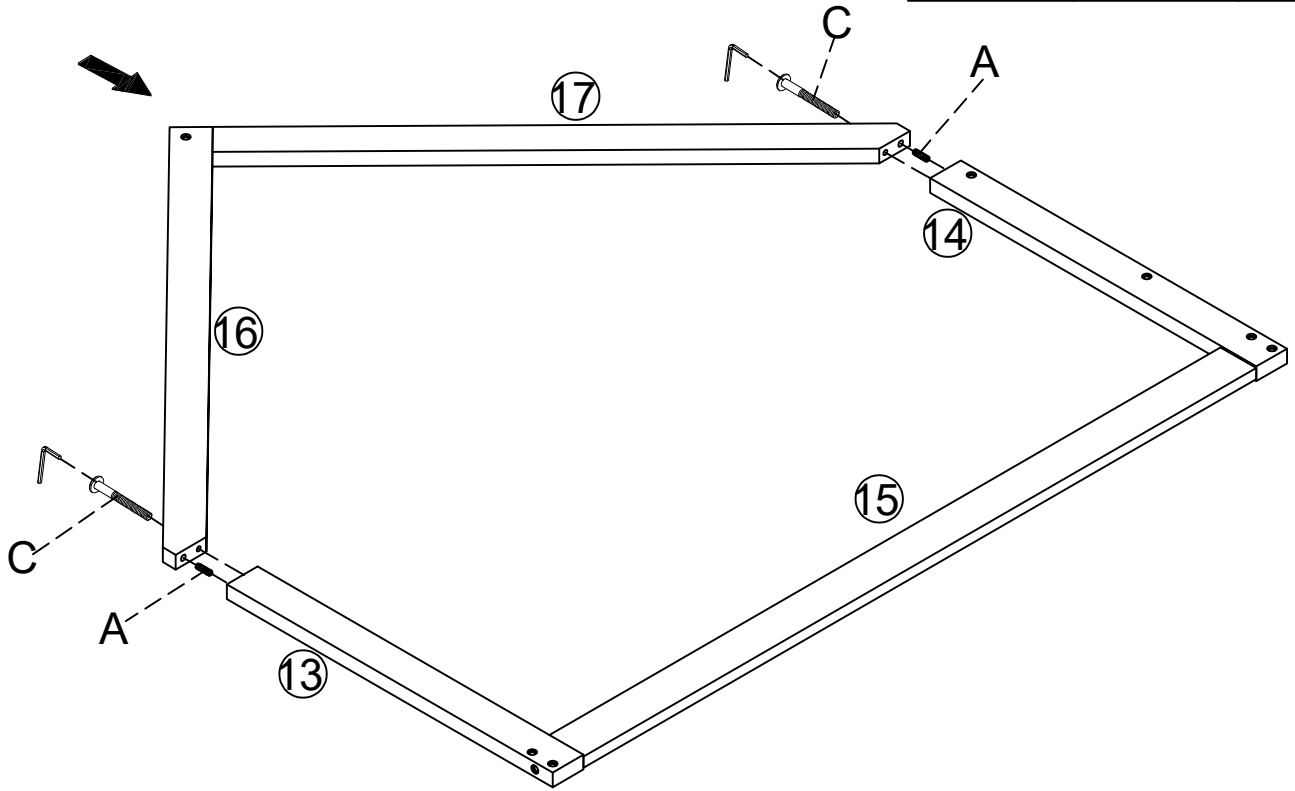
STEP 9:
(ÉTAPE 9)

H	C	A
		
	2PCS	2PCS



STEP 10:
(ÉTAPE 10)

H	E	C	A
			
	15PCS	15PCS	7PCS

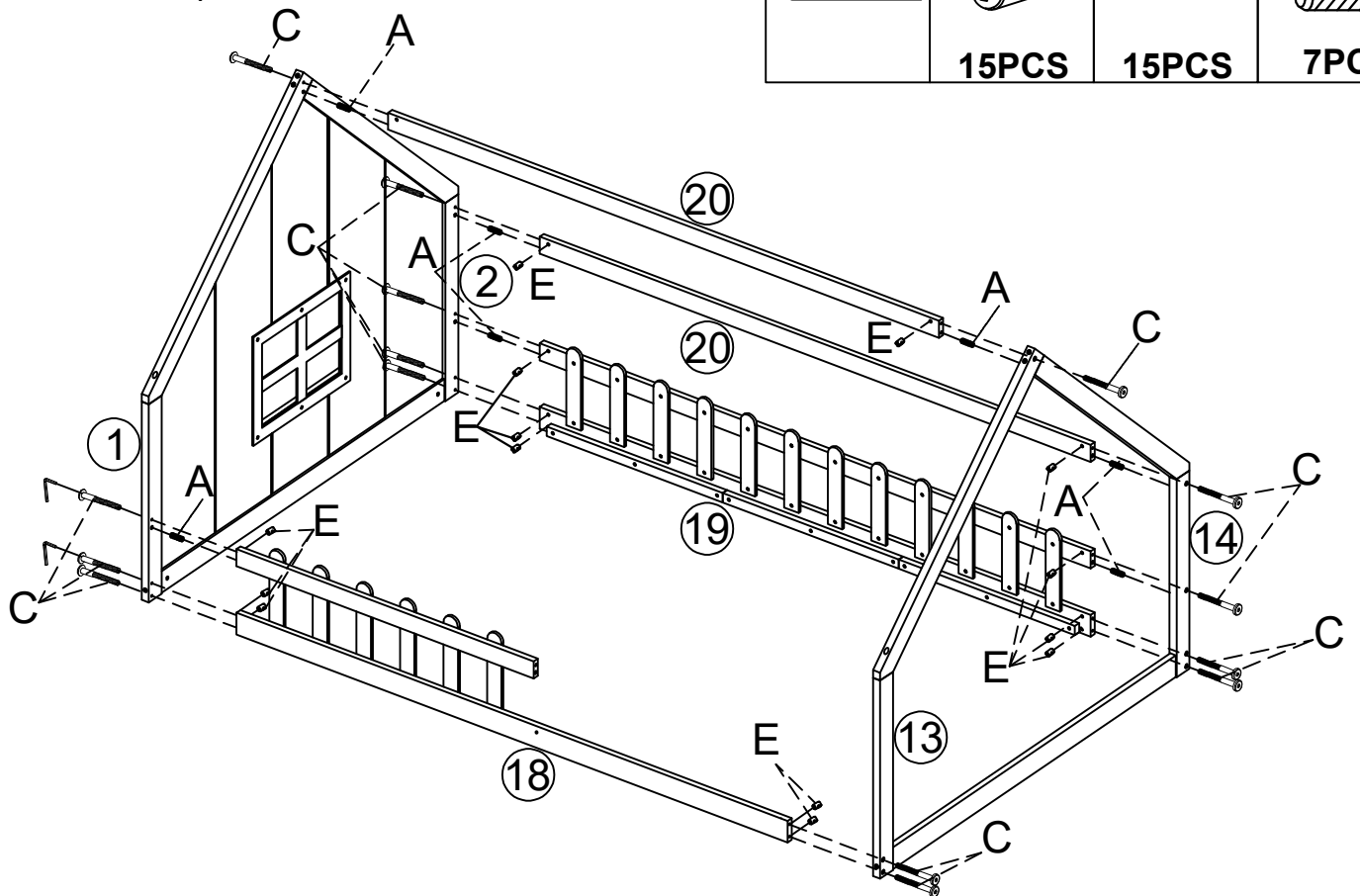

STEP 11:
(ÉTAPE 11)

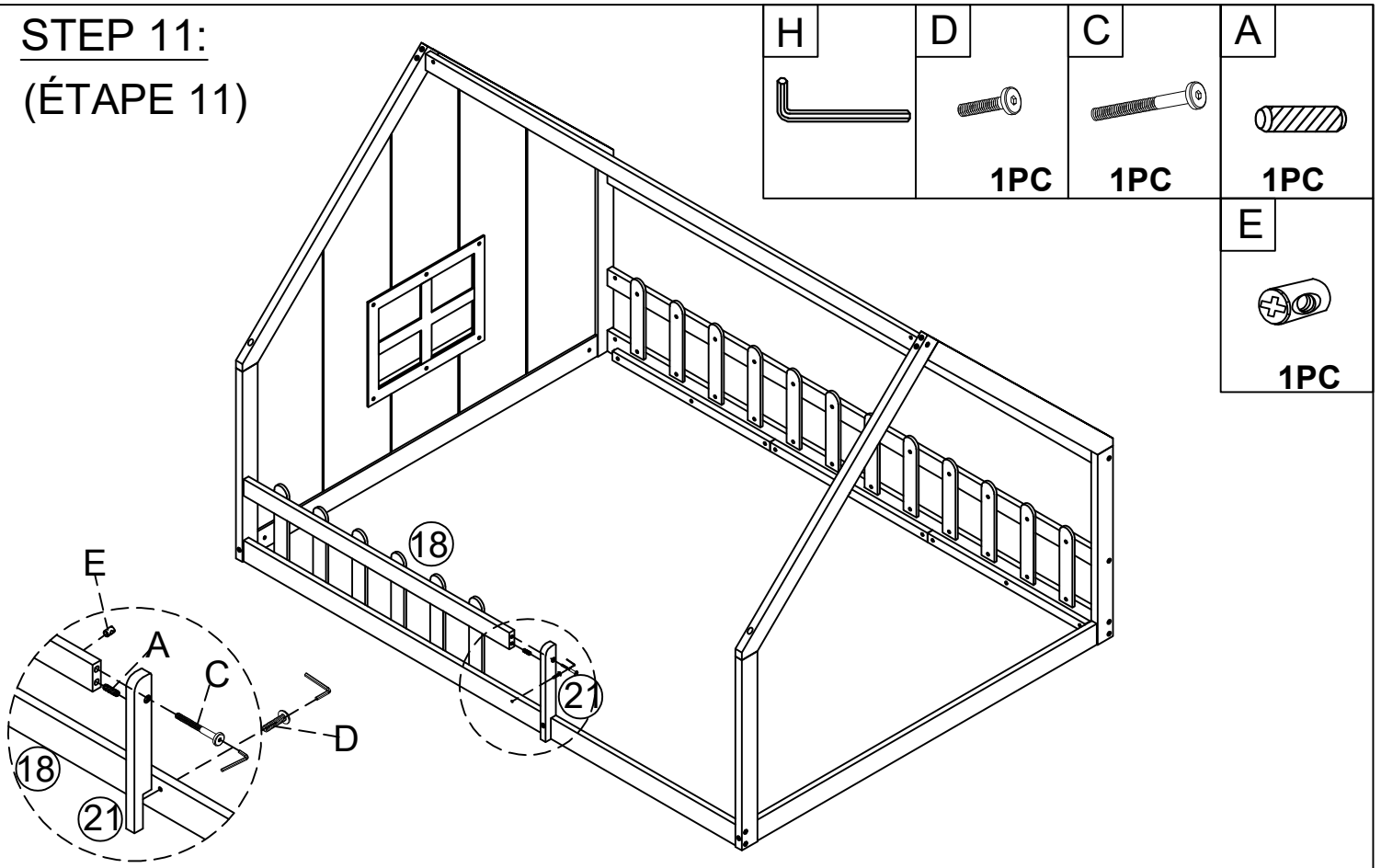

STEP 12:
(ÉTAPE 12)

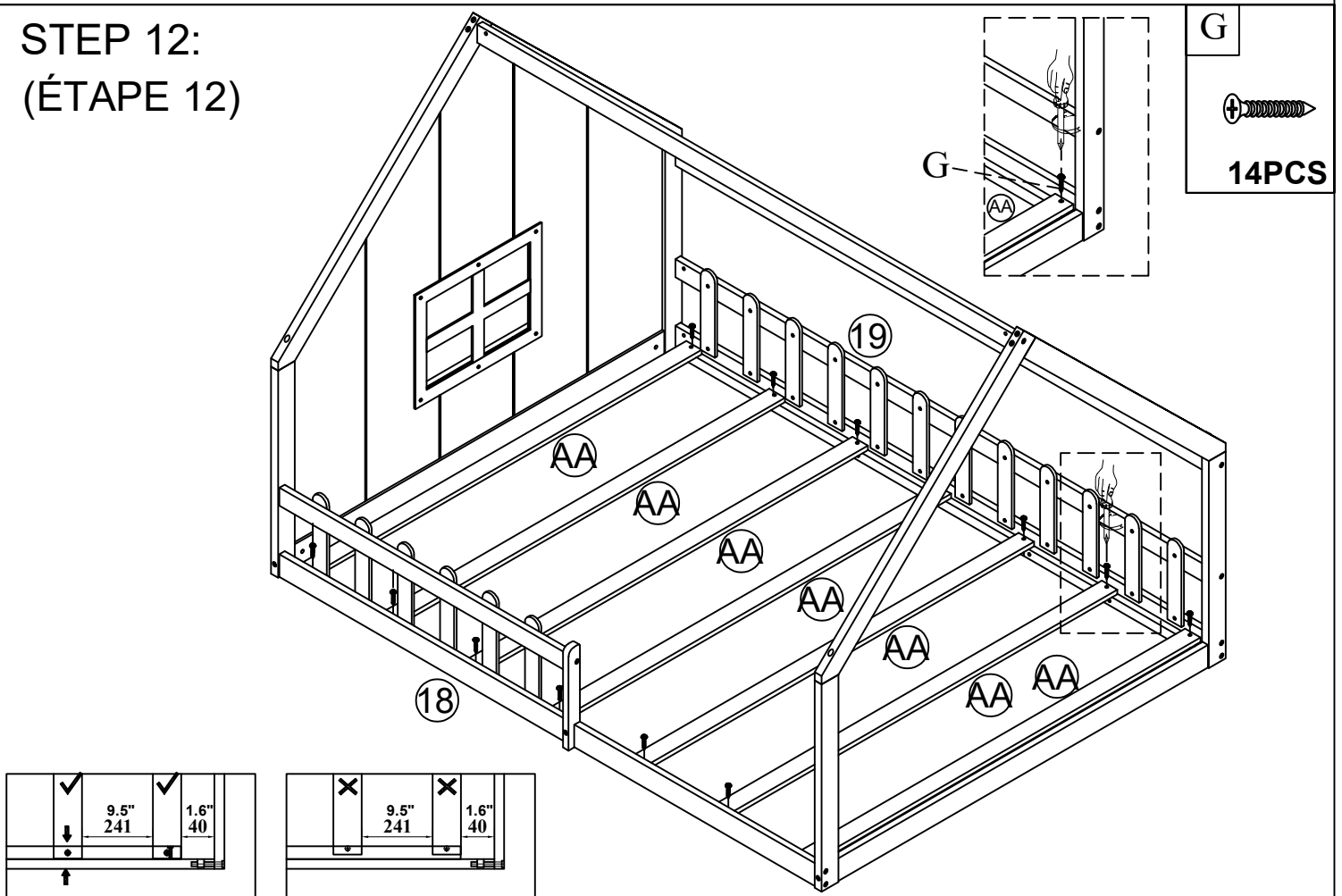



NOTE: Please make sure the bed slats close to the side rail before locking the screws to avoid breakage. This step is required for both the left and right sides. Moreover, please do not lock the screws of the bed slats at the outermost edge to avoid damaging.

REMARQUE : assurez-vous que les lattes du lit sont proches du rail latéral avant de verrouiller les vis pour éviter toute casse. Cette étape est nécessaire pour les côtés gauche et droit. De plus, veuillez ne pas verrouiller les vis des lattes du lit sur le bord le plus extérieur pour éviter de les endommager.

STEP 13:

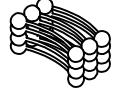
(ÉTAPE 13)

K	J	I
		
5PCS	1PCS	5PCS

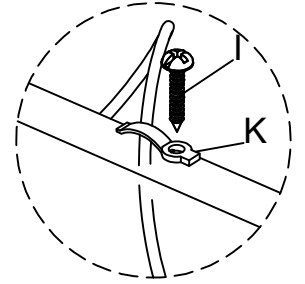
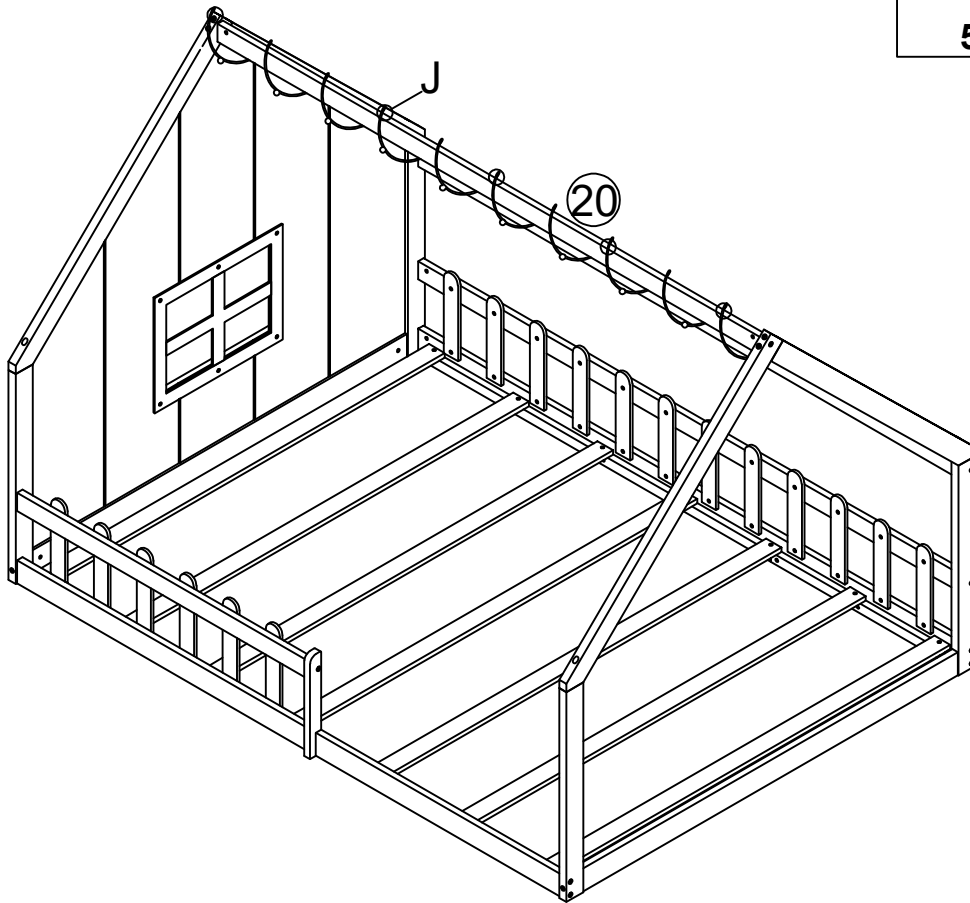

STEP 14:

(ÉTAPE 14)

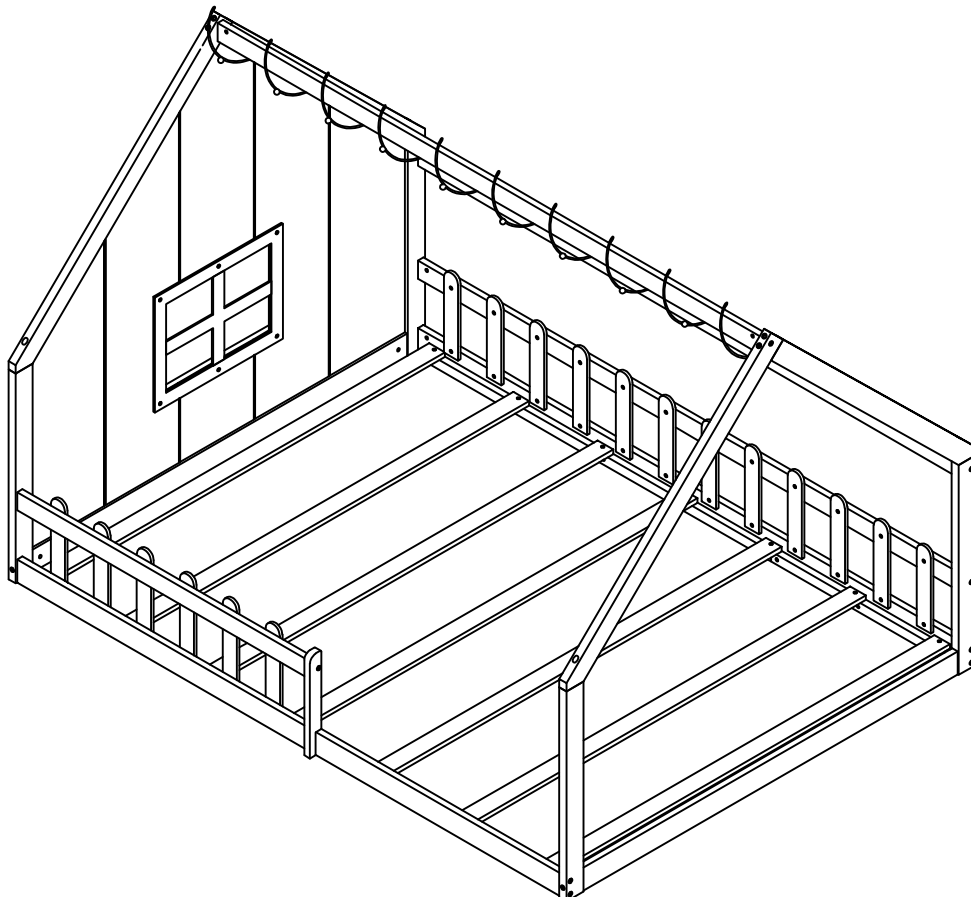

Please note: this Bed can only be used on a flat, level surface.

Attention : ce lit ne peut être utilisé que sur une surface plane et horizontale.