

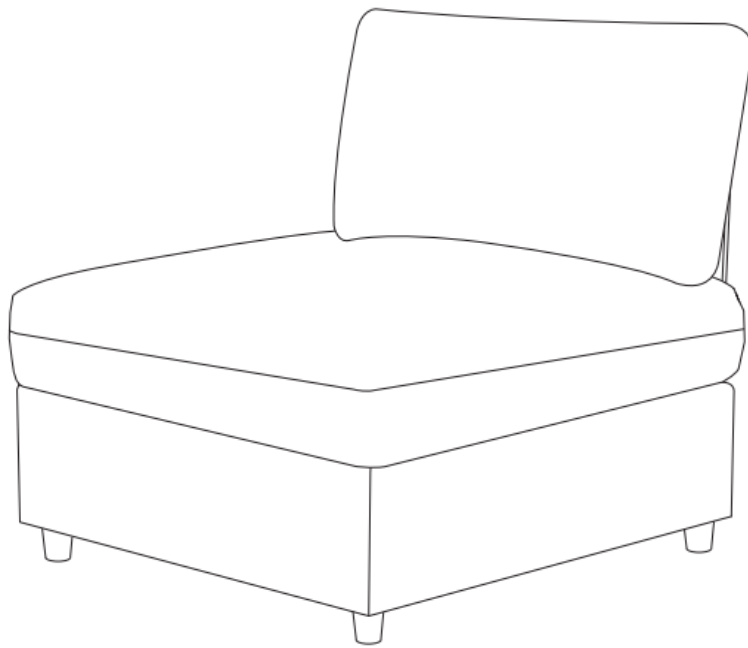

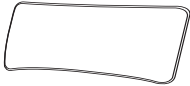

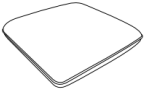

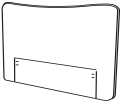

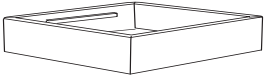

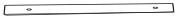

# Assembly Instructions

**Note: Please help to read my instruction before you ready to assemble.**

## Sofa



<b>Part List</b>			
<b>Label</b>	<b>Picture</b>	<b>Description</b>	<b>QTY (PCS)</b>
A		Back Cushion	2
B		Seat Cushion	2
C		Arm / Backrest	2
D		Seat Frame	2
E		Seat Panel	2
F		Wood Batten	4
G		Leg	8

<b>Hardware List</b>			
①		Plastic Washer	9
②		Metal Hook	4
③		Bolt(M6*35MM)	9
④		Flat Washer(M6)	9
⑤		Bolt(M6*20MM)	13
⑥		Metal Connector	2
⑦		Plastic Clip	4
⑧		Allen Wrench(S4)	1

STEP 1

x2

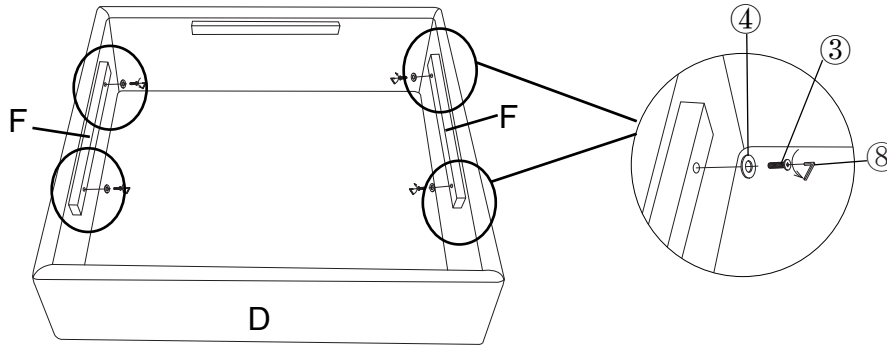

STEP 2

x2

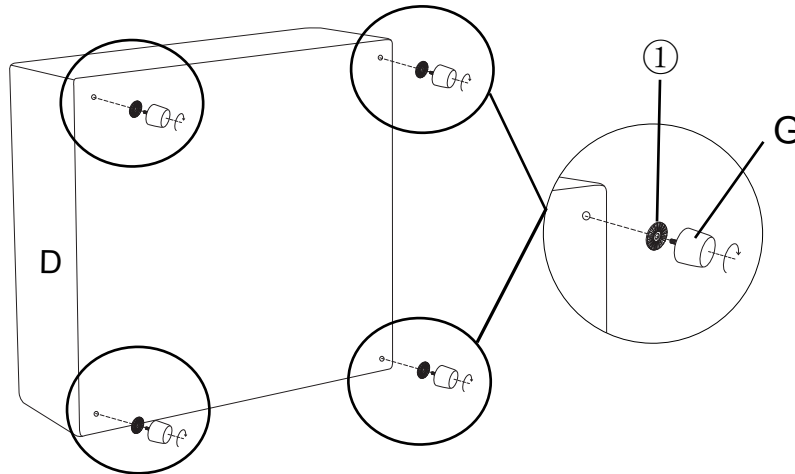

STEP 3

x2

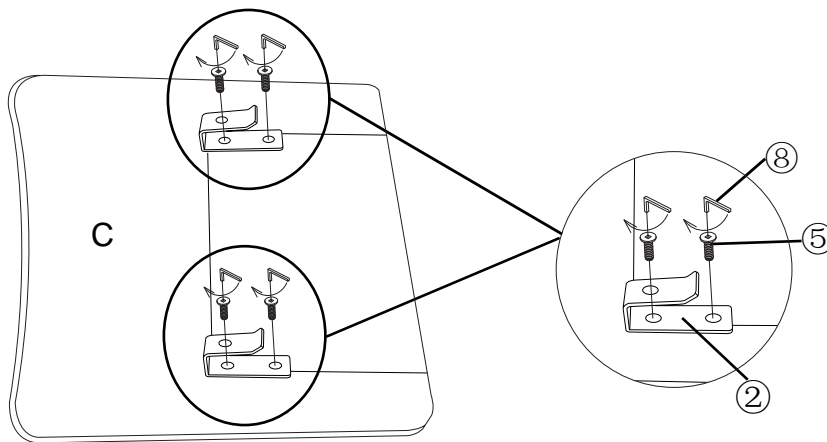

STEP 4

x2

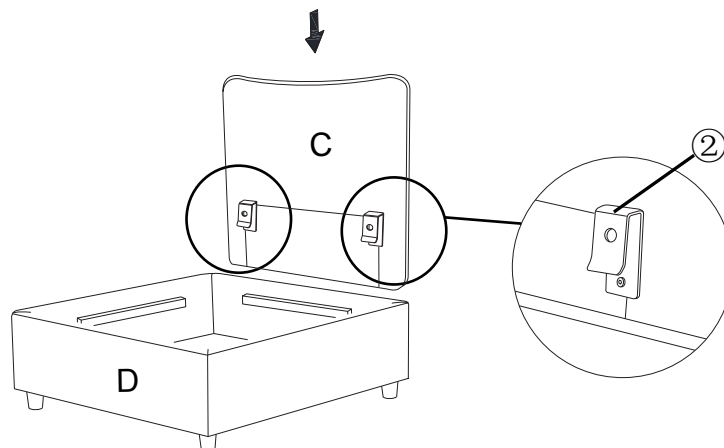

# STEP 5

X2

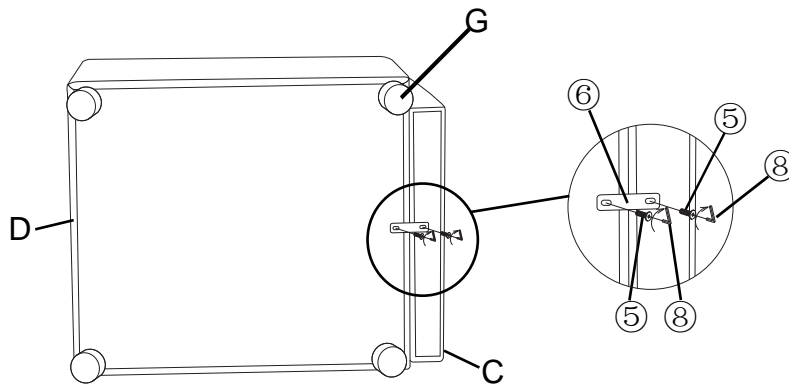

# STEP 6

X2

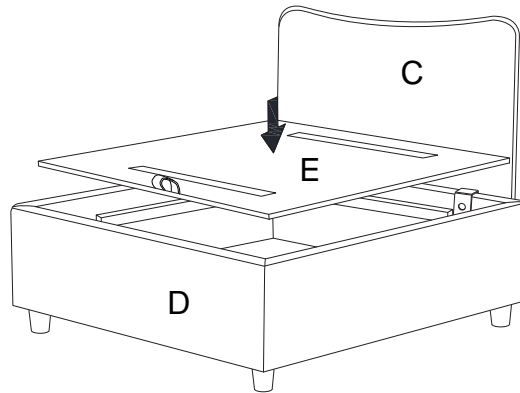

# STEP 7

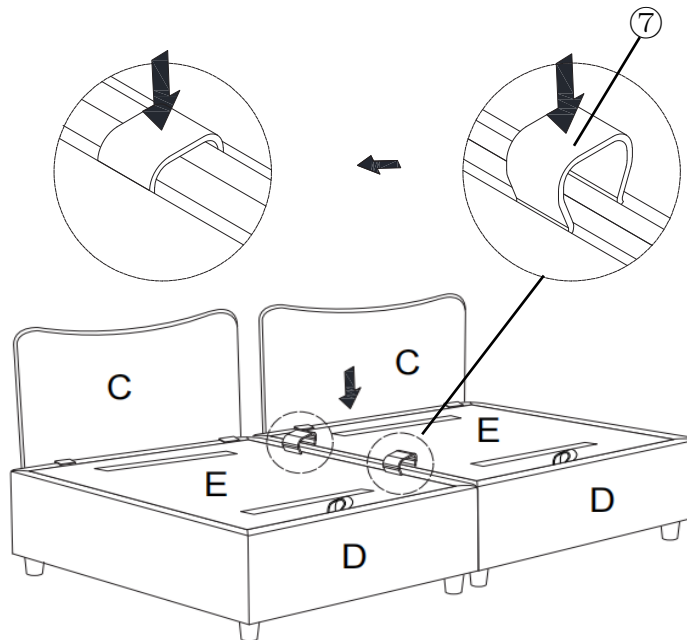

# STEP 8

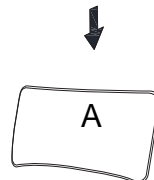
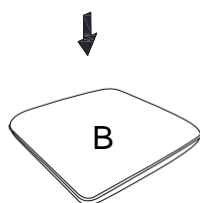
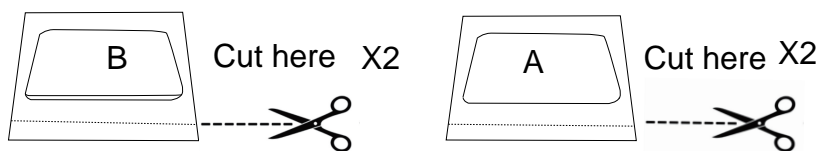

All cushions need slap and let stand 48 hours.

## STEP 9

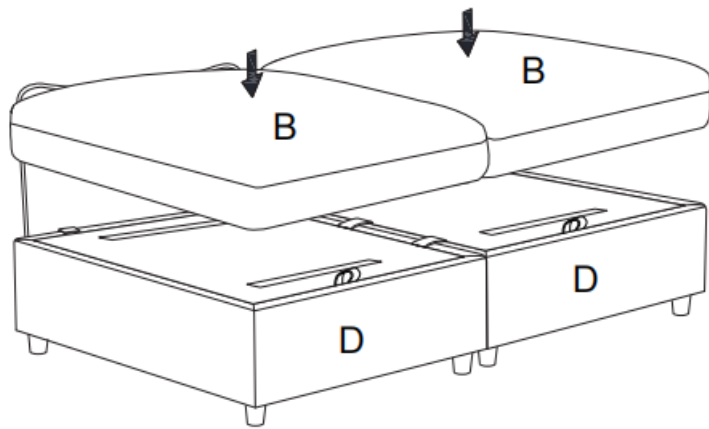

## STEP 10

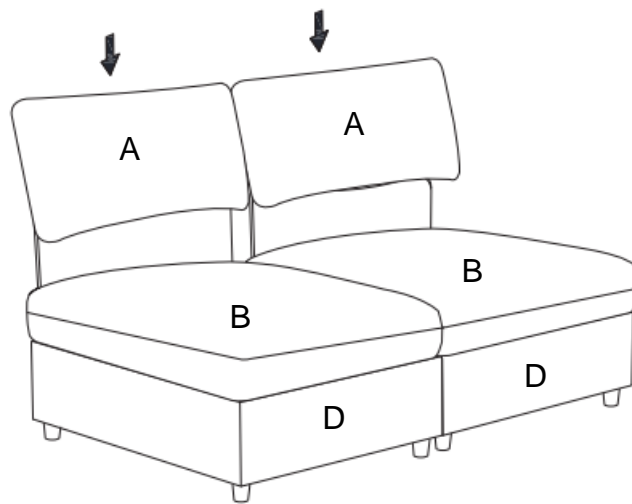

## STEP 11

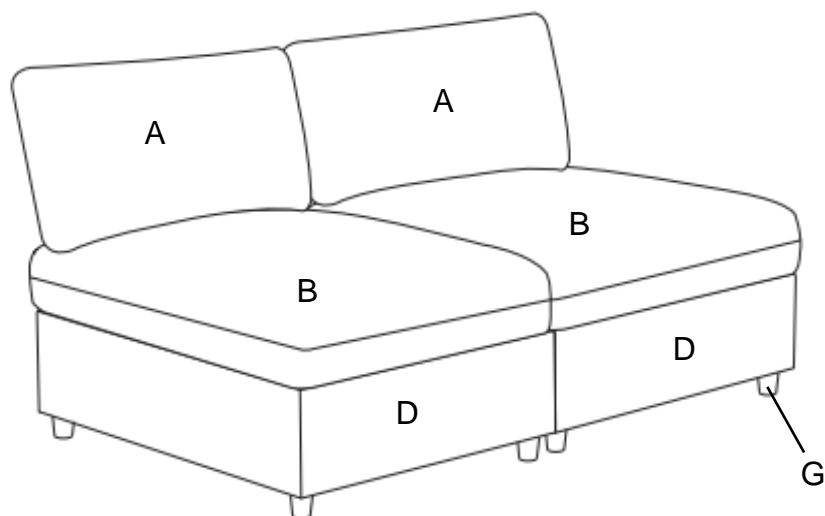

## Combine 1

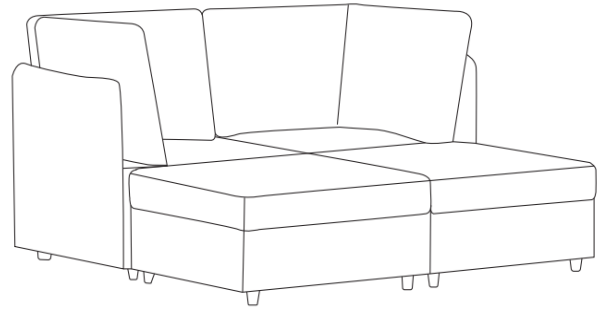
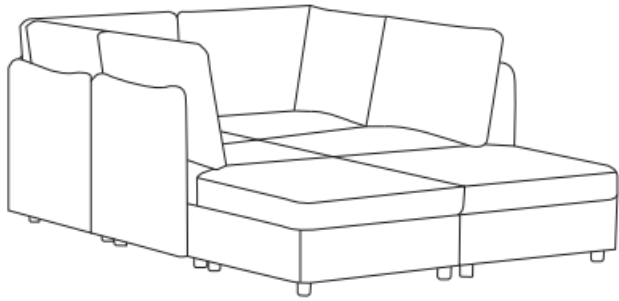

## Combine 2

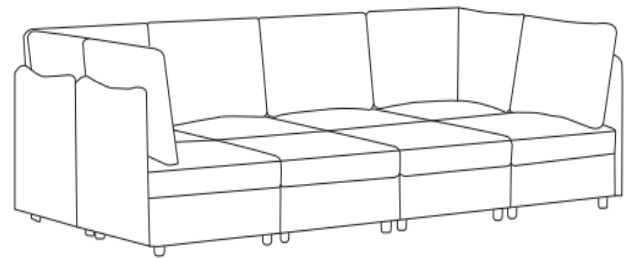
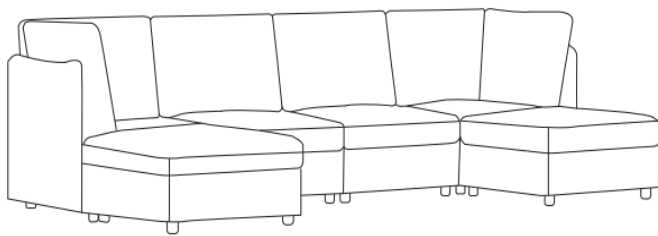

## Combine 3

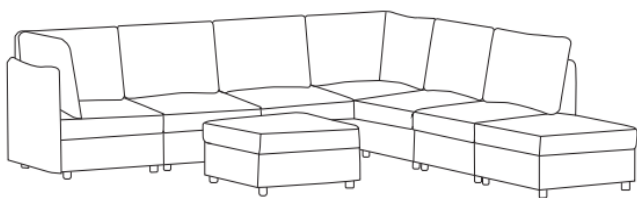

## Combine 4

