



A\*1



G\*2



M6\*18MM

B\*1



H\*6



M6\*25MM

C\*1



I\*2



0.5CM

D\*1



J\*4



φ6\*φ18mm

E\*5



K\*1



F\*1



1

Please take out and throw away the cap before assembling

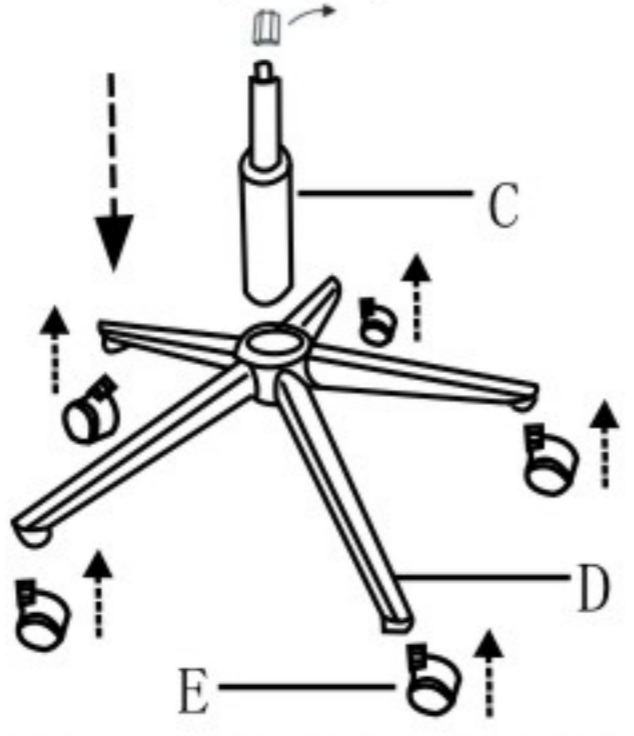

2

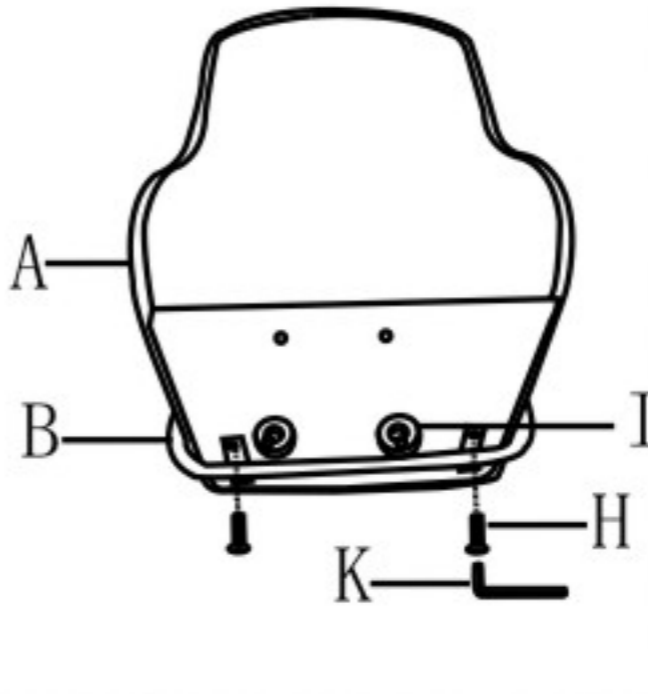

3

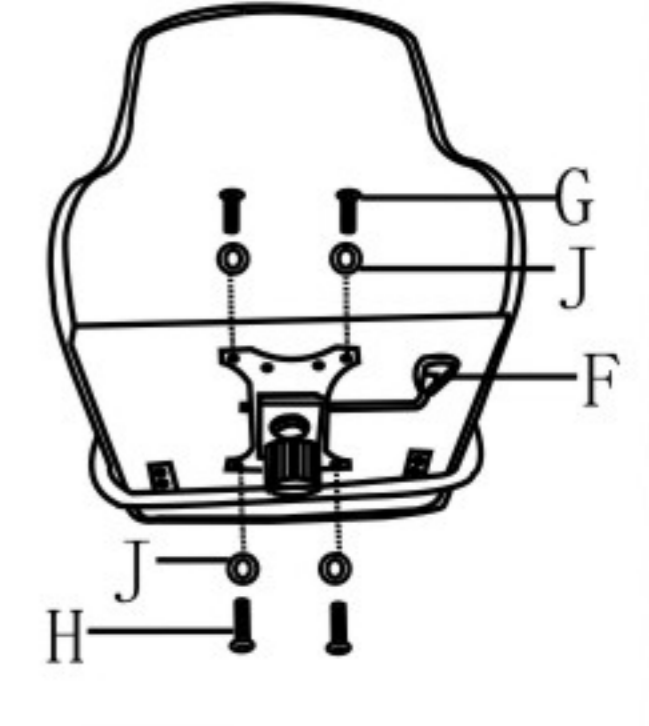

4



5

