

INSTRUCTION

Upholstered Platform Bed

Caution: Read owner's manual completely before assembly and use.

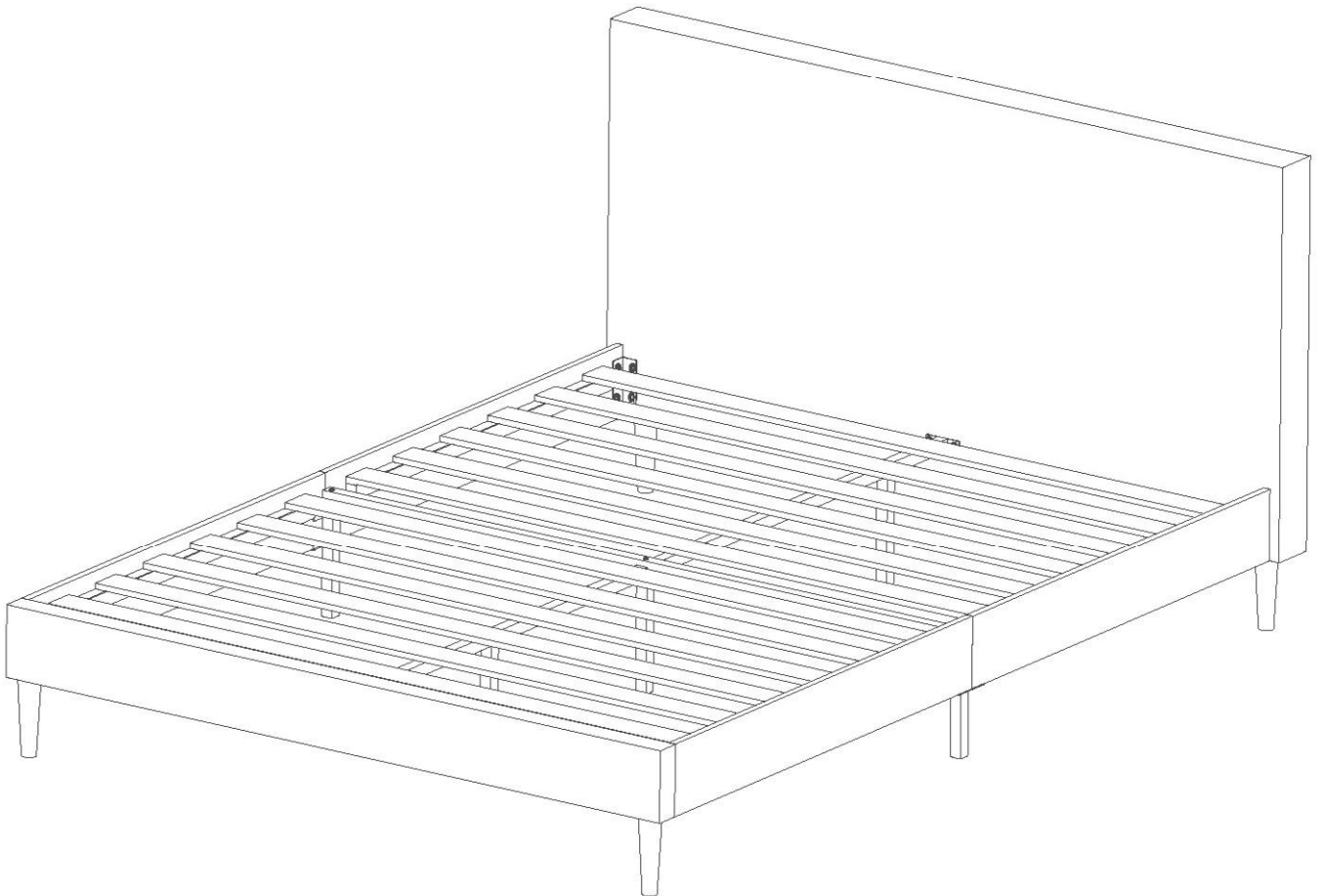

Product code: U057-030-100/U057-050-100/U057-030-200/U057-050-200/U057-060-100/U057-060-200

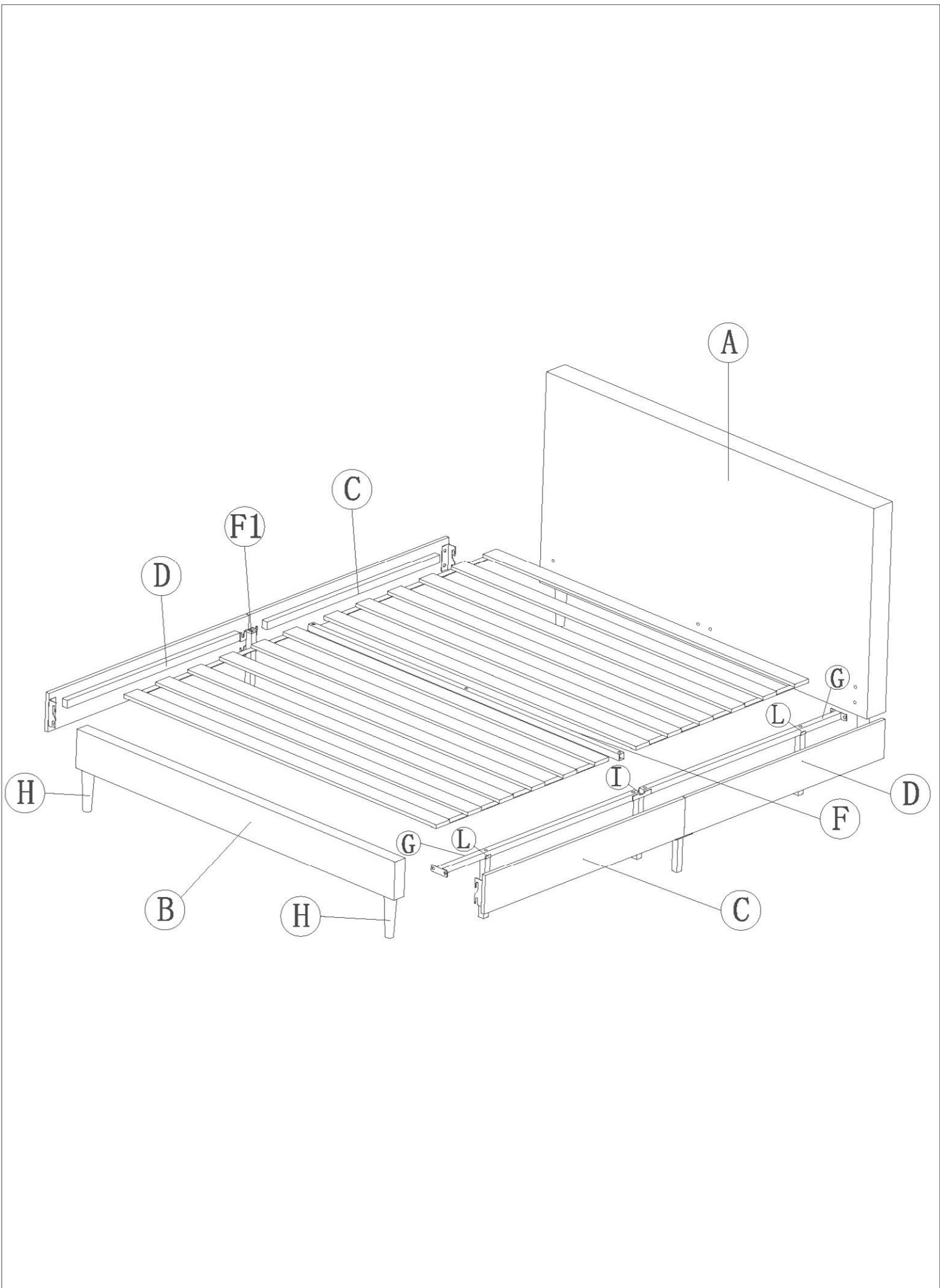





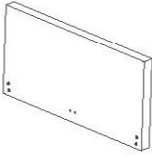
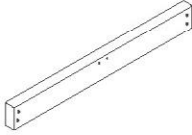
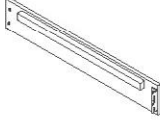
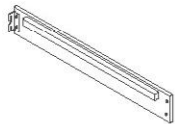
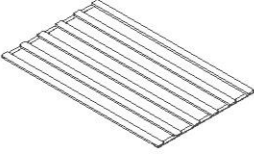

Parts list
Check all parts before assembly



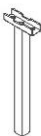

Parts:

<p>A: Headboard</p>  <p>X1</p>	<p>B: Footboard</p>  <p>X1</p>	<p>C: Side Rail</p>  <p>X2</p>	<p>D: Side Rail</p>  <p>X2</p>
<p>E: Slats</p>  <p>X2</p>	<p>F: Reinforcement Support</p>  <p>X1</p>		

Parts:

<p>G: Middle metal Support</p>  <p>X2</p>	<p>H: Wood Leg</p>  <p>X4</p>	<p>F1: Side Rail Support Leg</p>  <p>X2</p>	<p>I: Middle metal Leg</p>  <p>X1</p>
<p>L: Reinforcement metal Leg</p>  <p>X2</p>			

Hardware :

<p>1. Bolt</p>  <p>M8x25 X4</p>	<p>2. Bolt</p>  <p>M8x35 X6</p>	<p>3. Bolt</p>  <p>M8x50 X1</p>	<p>4. Allen Key</p>  <p>35*70*M5 X1</p>
---	---	--	---

Step1 NOTE: Loosen all screws on headboard(A),footboard(B), and bed frame(C)(D),but don't remove them completely.

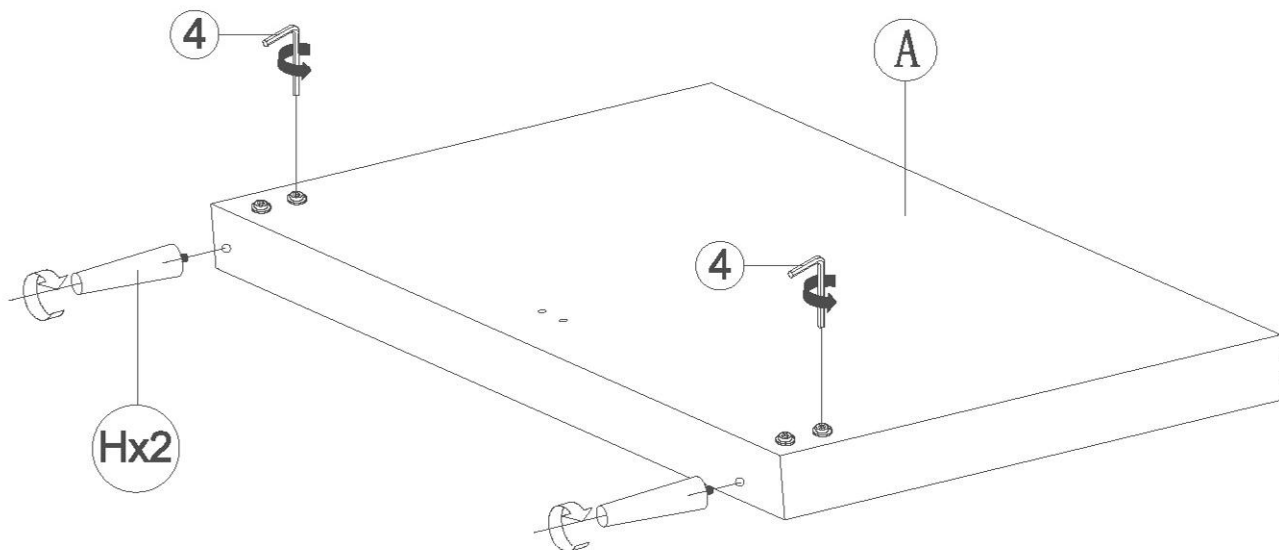

Step2

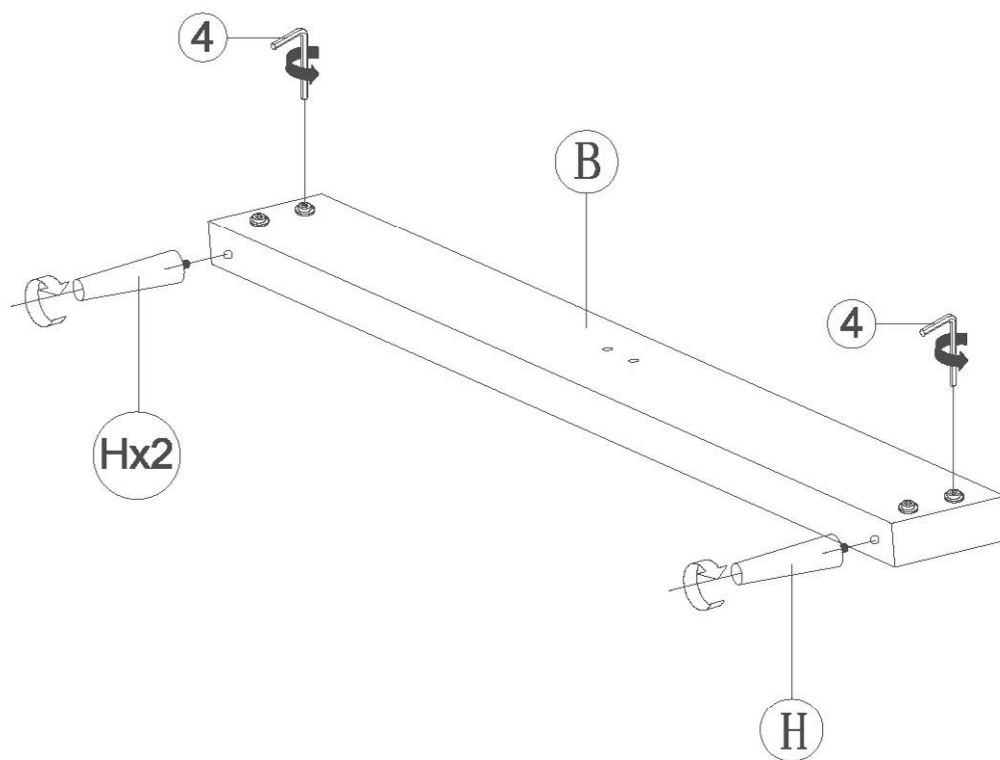

Step3

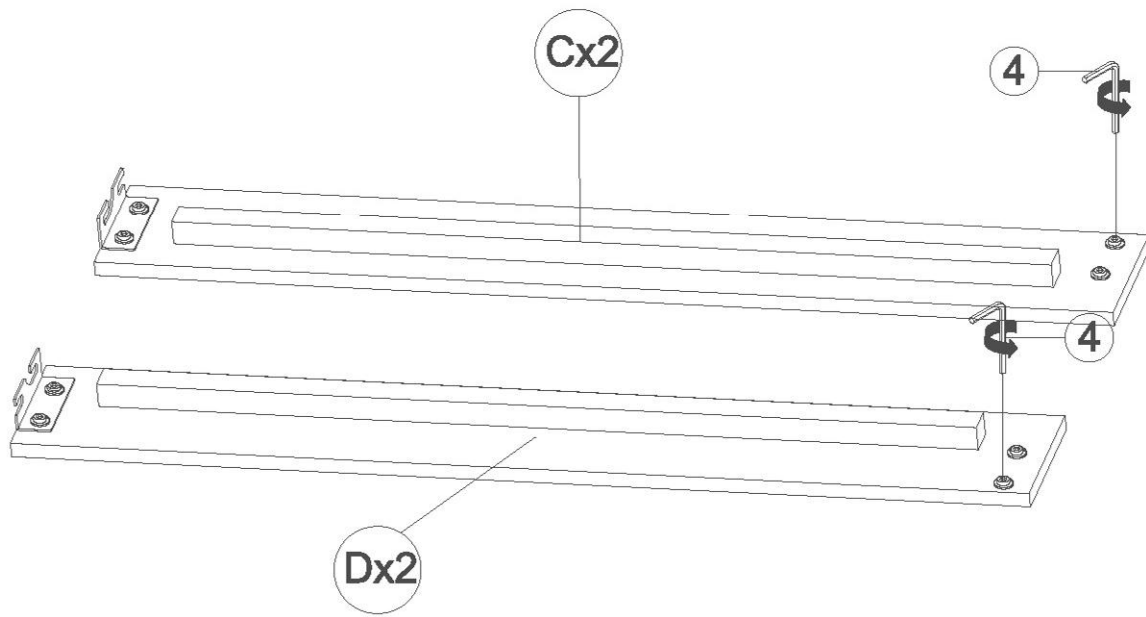

Step4

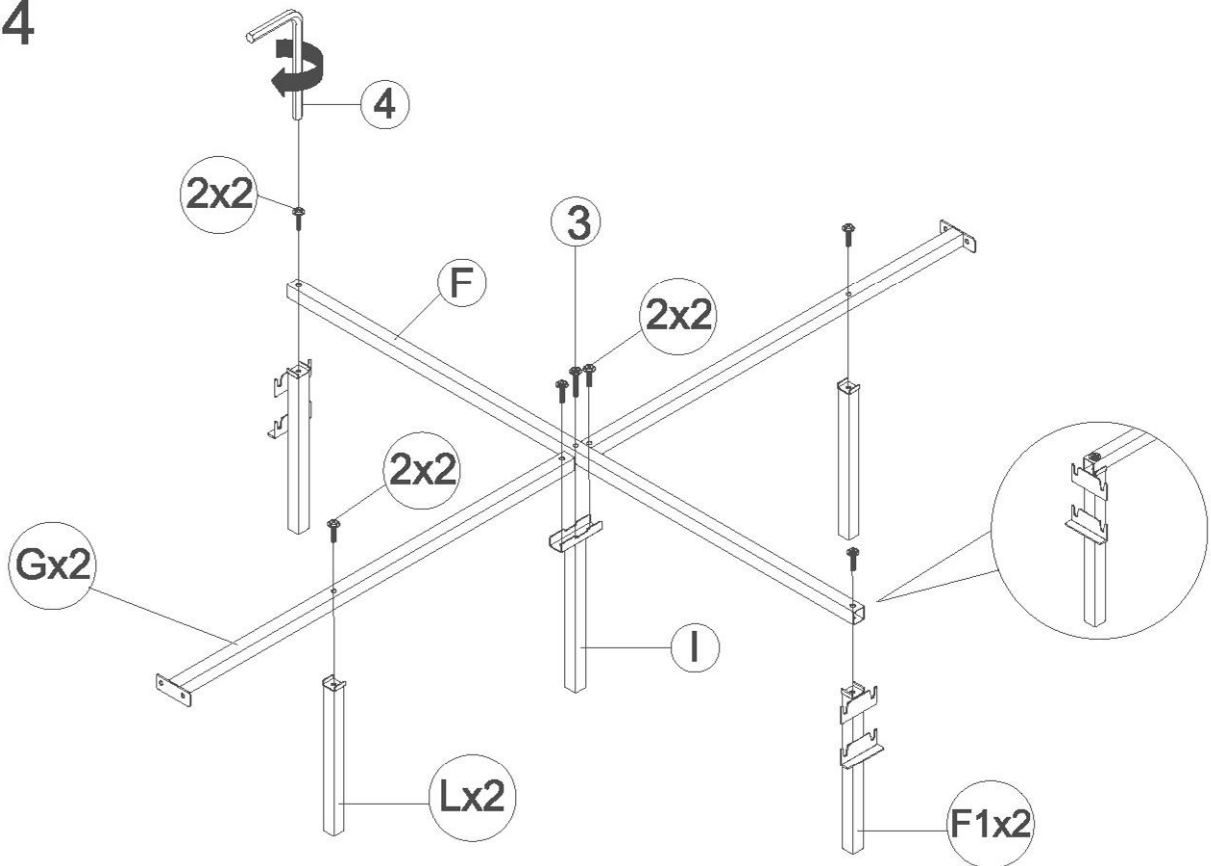

Step5

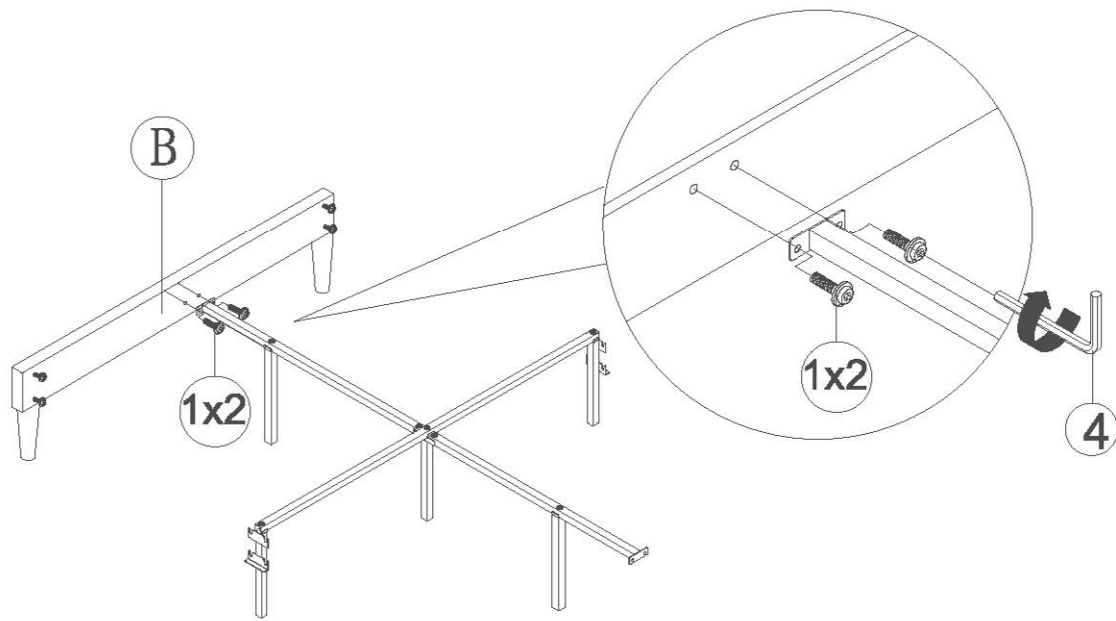

Step6

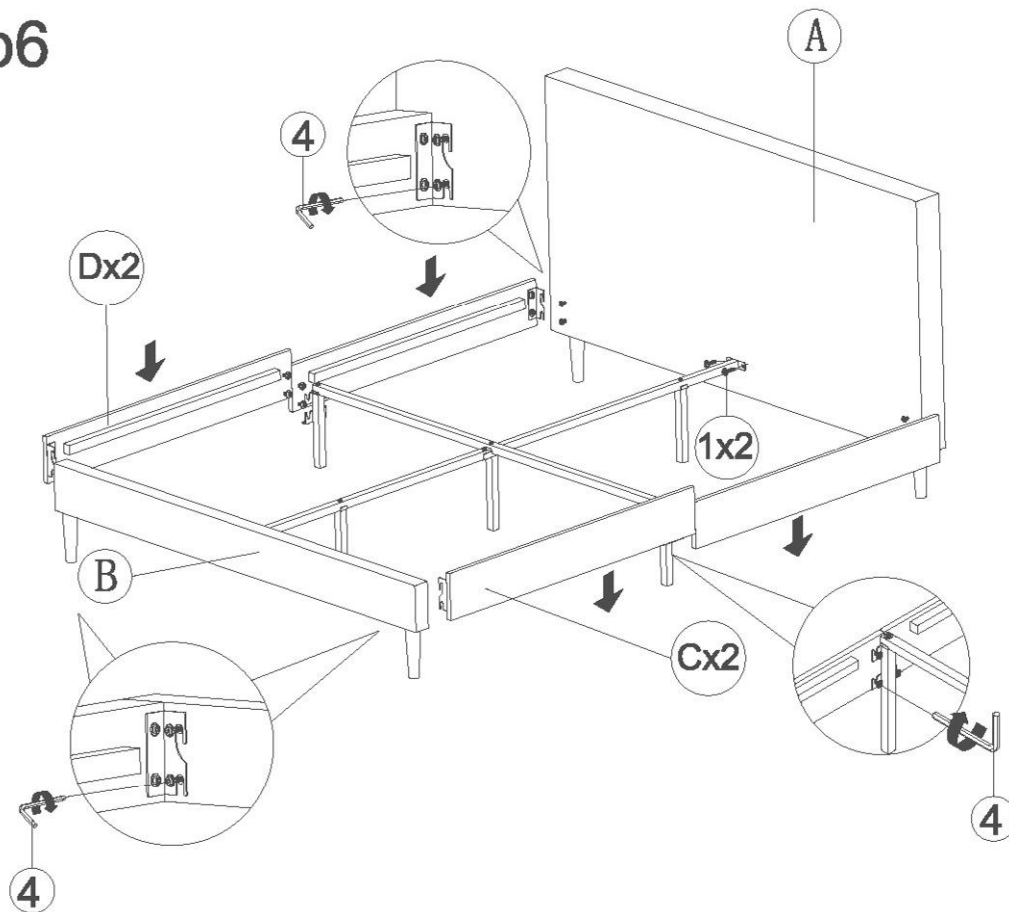

Step 7

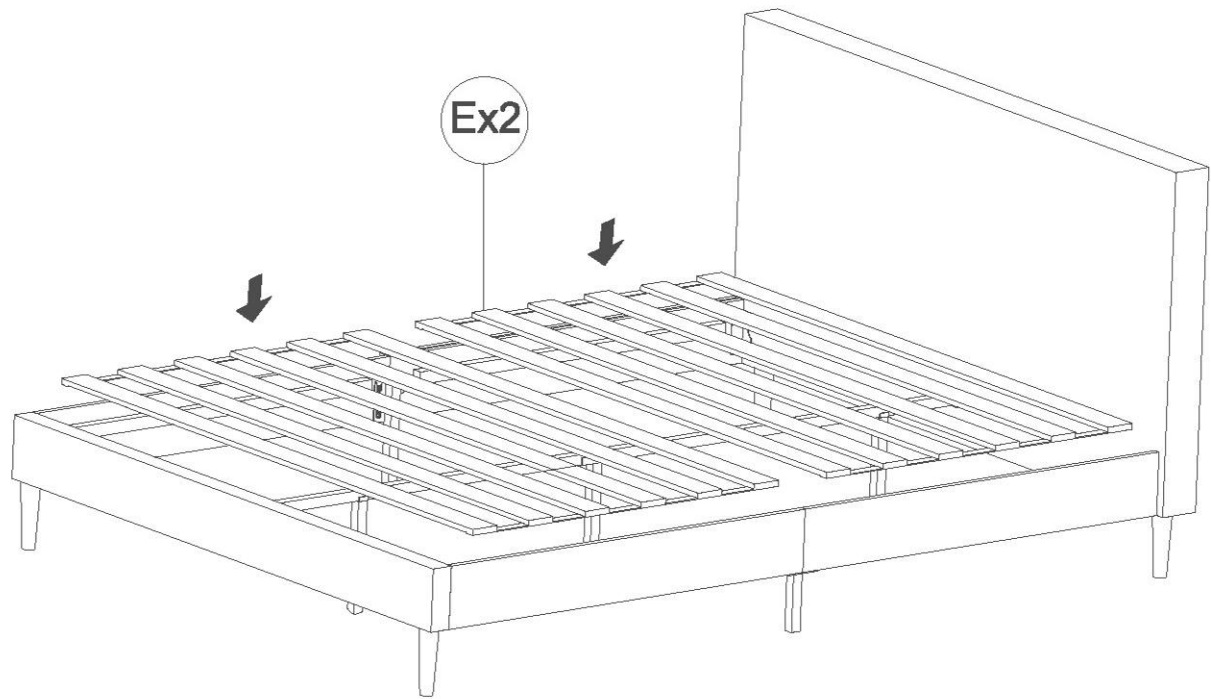

Assembly finished

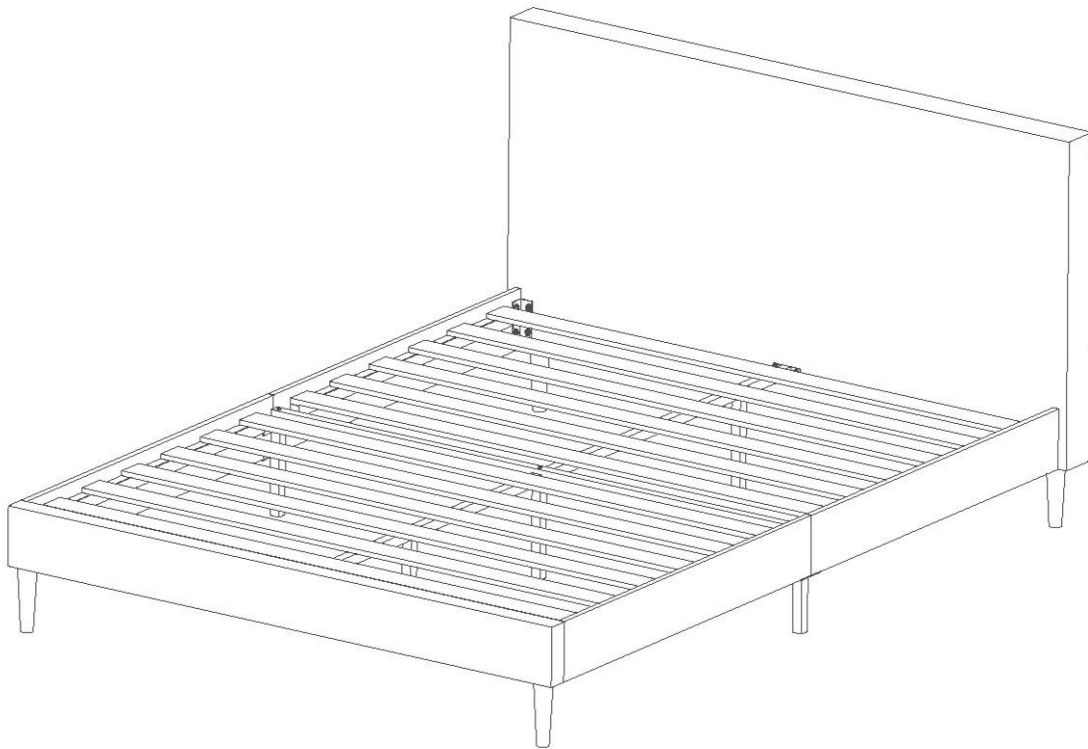

Warning!

When the assembly bed needs to move, it can't be directly pushed and pulled. First of all, the foot of the bed should be lifted off the ground and then moved. Otherwise, the support rod in the middle of the bed can be crooked or broken.

