

# BED

---

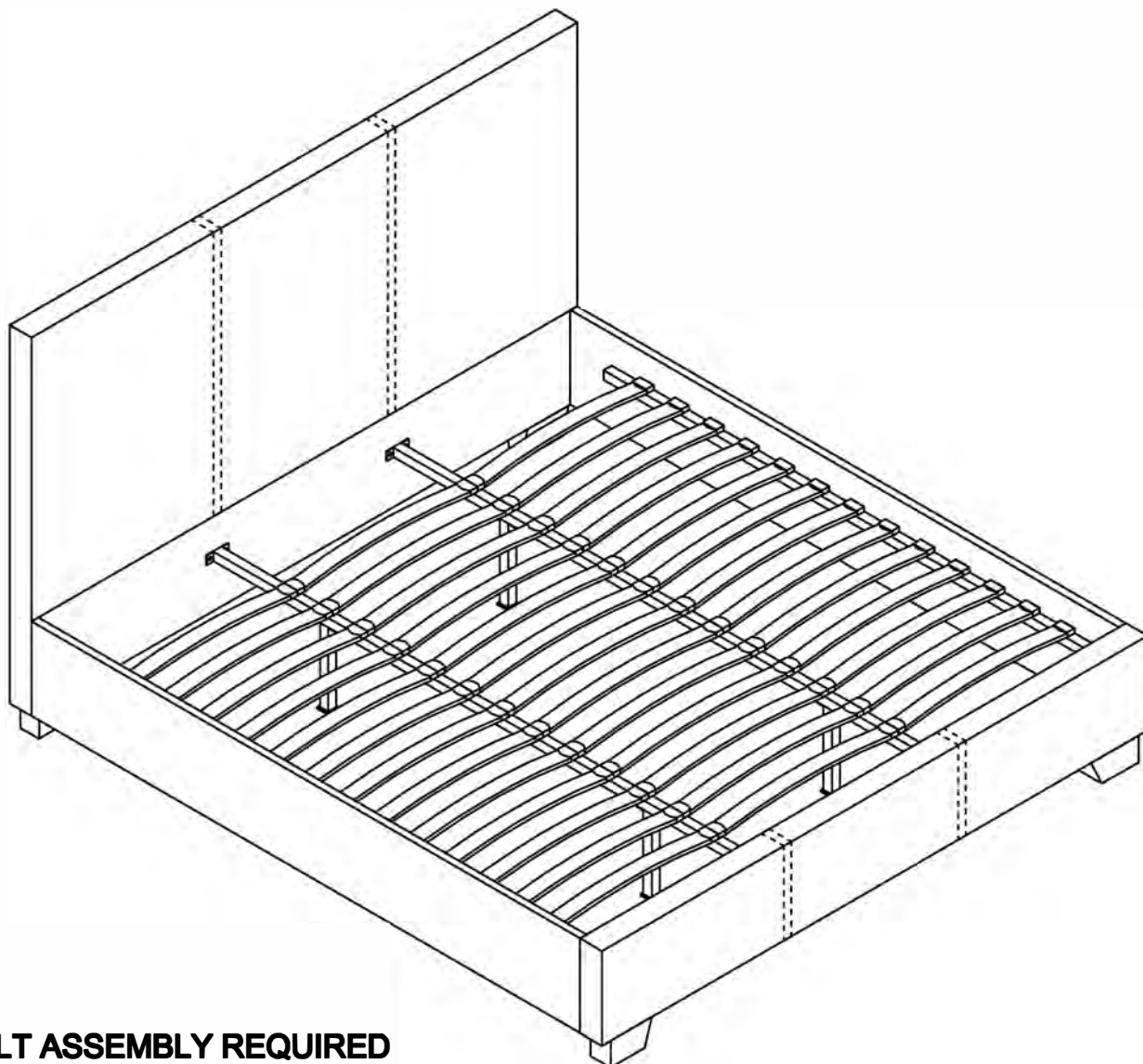









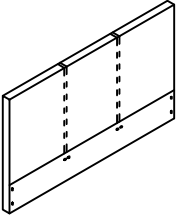
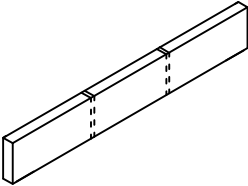
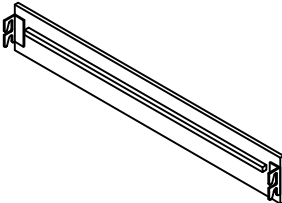
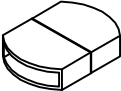
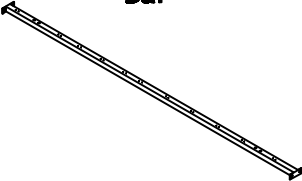
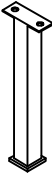
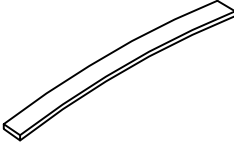

## ADULT ASSEMBLY REQUIRED

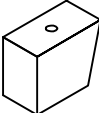
If you are missing any parts or have any questions regarding assembly, do not return this item to the retailers store. Please call our toll free customer service number and have this assembly manual open to the parts list ready to provide the model name, and part name or number .



**WARNING: This Product contains Small Components—Please ensure they are kept away from small children.**

# PARTS LIST

- |   |   |   |   |
|---|---|---|---|
| ①-Head Board (1pc)  | ②-Foot Board (1pc)  | ③-Side Rails (2pcs)   | ④-Double Plastic cap (26pcs)  |
|    |    |   |    |
| ⑤-Center Support (2pcs) Bar   | ⑥-Support Legs (4pcs)   | ⑦-Slats (39pcs)   | ⑧-Single Plastic cap (26pcs)  |
|     |    |   |    |
| ⑨-Legs (4pcs)   | A Bolt M8*30mm 16pcs  | B Bolt M8*45mm 8pcs   | C Nut M8*13mm 8pcs  |
|    |    |    |    |
| D Spring Washer 8pcs  | E Flat Washer 8pcs  | F Allen Key M5 1pc  | G Spanner 1pc   |
|  |  |  |  |
| H Bolt M8*50mm 4pcs   |   |   |   |
|  |   |   |   |

**STEP 1: ATTACH THE LEGS PROVIDED. (9) TO THE HEADBOARD(1) AND FOOTBOARD(2) USING THE 4PCS OF M8 BOLTS PROVIDED (H).TIGHTEN THE BOLTS USING THE PROVIDED ALLEN KEY (F)**

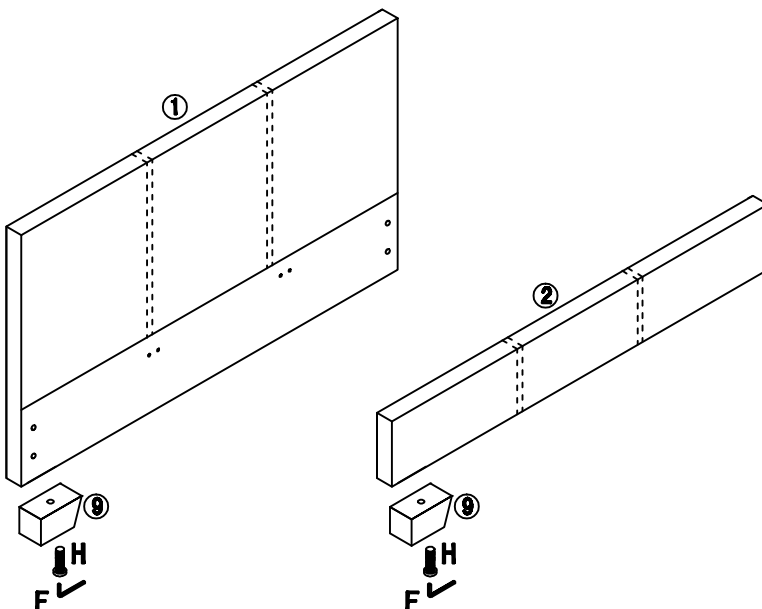

**STEP 2: ATTACH THE TWO SUPPORT LEGS(6) TO THE CENTER SUPPORT BAR(5) USING THE SUPPLIED M8 BOLTS(B) AND NUTS (C).TIGHTEN USING THE SUPPLIED ALLEN KEY (F) AND SPANNER WRENCH(G)**

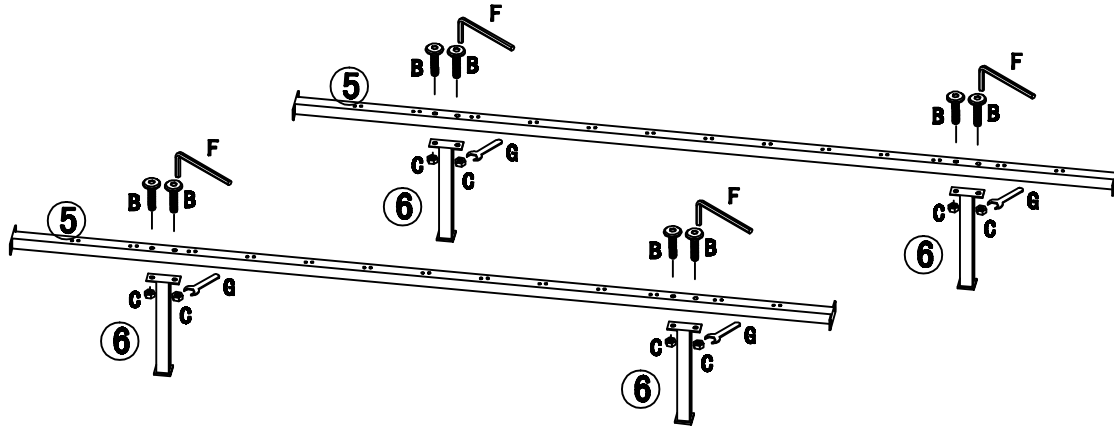

**STEP 3 : ATTACH THE CENTER SUPPORT BAR(5) W/SUPPORT LEGS AND THE TWO SIDE RAILS TO BOTH THE HB AND FB USING THE SUPPLIED M8 BOLTS(A) FLAT WASHERS(E). TIGHTEN USING THE SUPPLIED ALLEN KEY(F)**

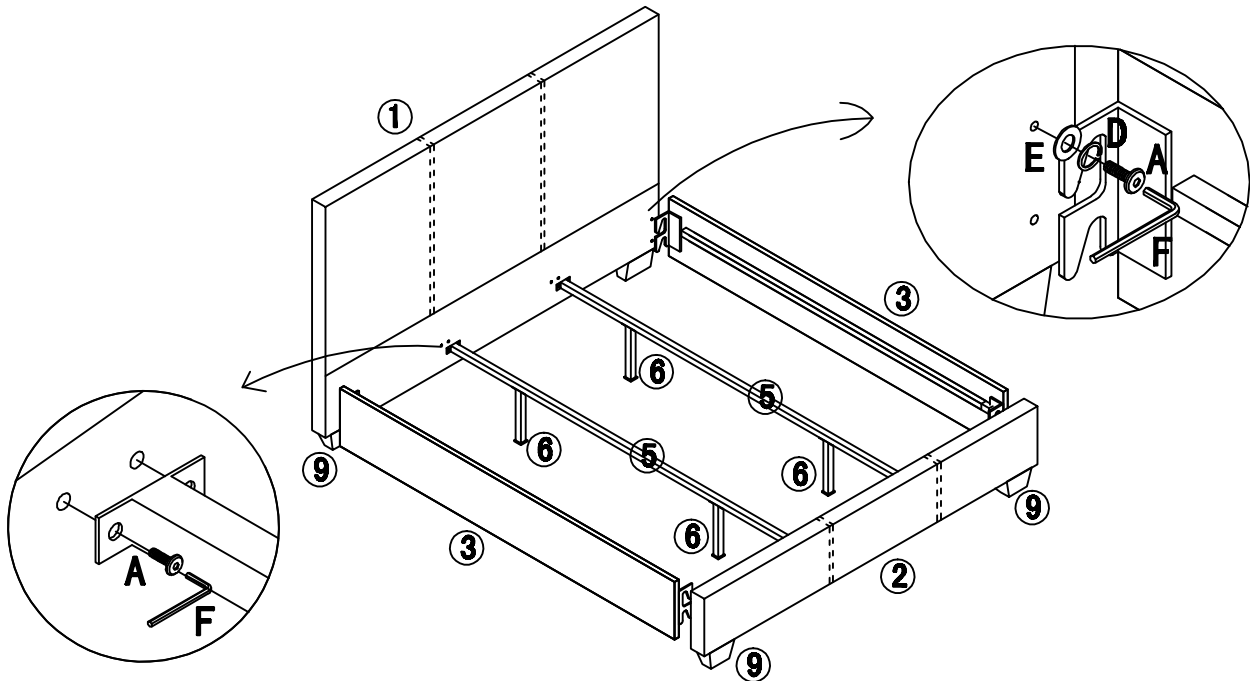

**STEP 4 : SLIDE SLATS INTO THE CENTER PLASTIC CAP(4) AND FIRMLY PRESS THE FIXED PLASTIC PEG FROM CENTER PLASTIC CAP INTO THE PRE DRILLED HOLES IN THE CENTER SUPPORT BAR. NEXT INSERT THE FREE SLAT END INTO THE END PLASTIC CAP AND FIRMLY PRESS THE PLASTIC PEG FROM THE PLASTIC END CAP INTO THE PRE DRILLED HOLES IN THE SIDE RAIL SUPPORT LEDGE.REPEAT UNTIL ALL SLATS ARE FRIMLY IN PLACE .**

