



SBC7BRSFRTPADALHD



32" x 23.63" x 27.38" (H x W x D)

24" wide commercially approved ADA-compliant front tap built-in beer dispenser in stainless steel

Highlights:

24" wide front tap kegerator includes all the equipment needed to serve beer

Innovative front tap system requires no countertop modification

Approved for both residential and commercial settings

Product Features:

24" Wide Front-Tap Beer Dispenser	Kegerator includes front taps accessed via the door and includes all of the equipment needed to serve beer from two sixtel kegs
Commitment-free front-taps	Unique design requires no alterations to your countertop, freeing up valuable countertop space
Dual tap system	Twin draft tower allows you to serve from two 1/6 (sixel) sized kegs
Built-In capable	Designed for installation under the counter
Accessible design	Taps are located on the front of the door, requiring no added reach
ADA-compliant height	Sized at 32 inches high (32.25 to hinge cap) for installation under lower ADA-compliant counters
Commercially listed	ETL-S listed to ANSI-NSF Standard 7 for commercial use
Versatile use	Approved for both residential and commercial settings
Complete beer tap kit included	Includes a 5 lb. CO2 tank and regulator, dual tap draft arm, Sankey American tap, and the needed connection hardware.



SBC7BRSFRTPADALHD Specifications:

Overview	
Height of Cabinet	31.88" (81 cm)
Height to Hinge Cap	32.0" (81 cm)
Width	23.63" (60 cm)
Depth	27.38" (70 cm)
Depth with door at 90°	51.88" (132 cm)
Capacity	5.3 cu.ft. (150 L)
Defrost Type	Automatic
Door	Stainless Steel
Cabinet	Black
US Electrical Safety	ETL
Canadian Electrical Safety	ETL-C
Sanitation	ETL-S
Energy Usage/Year	293.0kWh/year
Amps	0.8
Voltage/Frequency	115 V AC/60 Hz
Parts & Labor Warranty	1 Year
Compressor Warranty	5 Years
UPC	761101145426
Kegeerator	
Door Swing	LHD
Height Adjustable	Yes
Tap Kit	Yes
Number of Taps	2
Thermostat Type	Dial
Interior Light	Yes
Refrigerant	R600a
Refrigerant Amount	0.64 oz.
Inter Height	27.75" (70 cm)
Interior Width	21.0" (53 cm)
Interior Depth	18.0" (46 cm)
Compressor Step Height	5.5" (14 cm)
Compressor Step Width	21.0" (53 cm)
Compressor Step Depth	6.0" (15 cm)
Level Legs Qty	4
Temperature Range	36 to 46°F

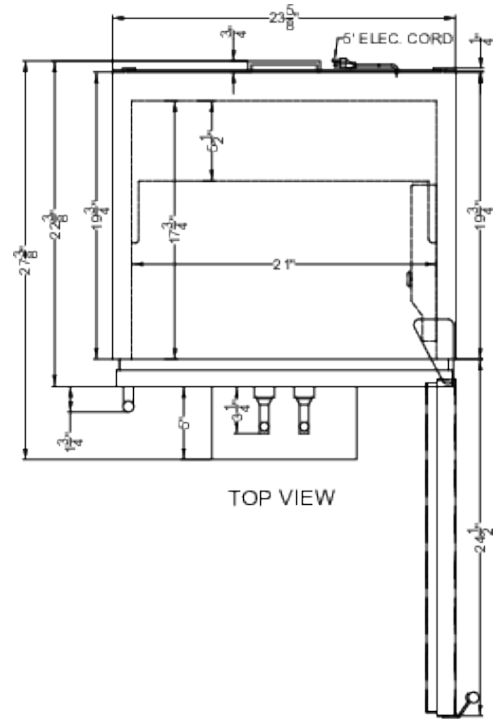

TOP VIEW

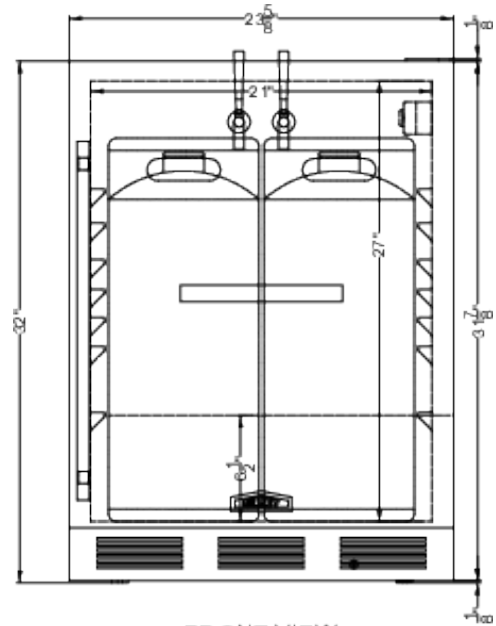

FRONT VIEW