

# ASSEMBLY INSTRUCTION

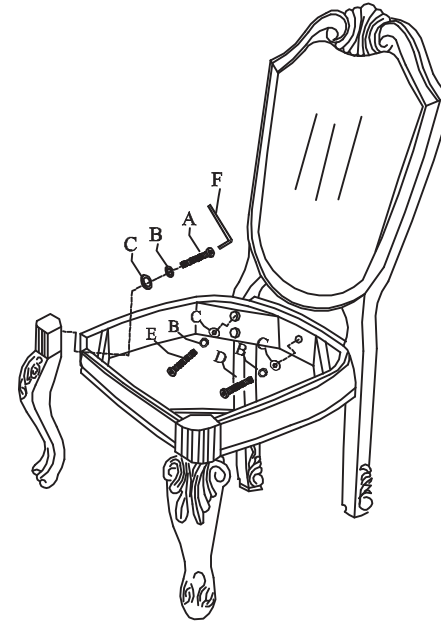





Thank you for purchasing this quality product. Be sure to check all packing material carefully for small parts which may have come loose inside the carton during shipment. Separate, identify and count all parts and hardware. Compare with the parts list to be sure all parts are present. "DO NOT TIGHTEN SCREWS UNTIL COMPLETELY ASSEMBLED"

**IMPORTANT:**  
PLEASE READ INSTRUCTION BEFORE STARTING THE ASSEMBLY

Step 1:



## Hardware List:

NO.	Description	Drawing	Size	Q'ty
<b>A</b>	Middle Bolt		Ø5/16" * 2-1/4"	4
<b>B</b>	Lock Washer		Ø5/16" * 12mm	9
<b>C</b>	Flat Washer		Ø5/16" * 22mm	9
<b>D</b>	Short Bolt		Ø5/16" * 1-1/2"	1
<b>E</b>	Long Bolt		Ø5/16" * 3-1/4"	4
<b>F</b>	Allen Wrench		5mm	1

Finish:

