

ASSEMBLY INSTRUCTIONS

DINING CHAIR

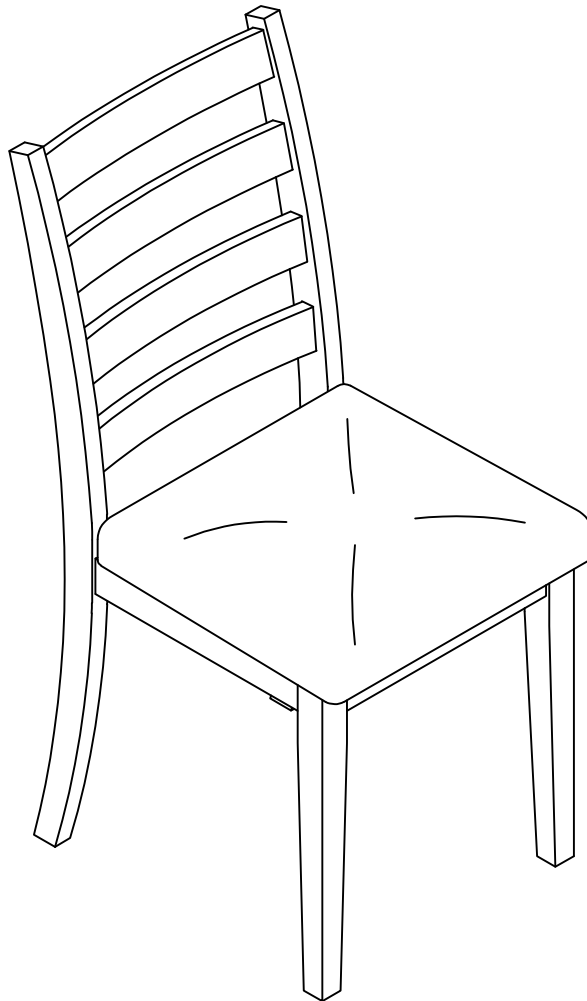

N715P383420D

IMPORTANT NOTE :

- ① PLACE ALL PARTS ON A CLEAN AND SMOOTH SURFACE SUCH AS A RUG OR CARPET TO AVOID THE PARTS FROM BEING SCRATCHED.
- ② BEFORE YOU BEGIN , KINDLY FOLLOW THE ASSEMBLY INSTRUCTIONS STEP BY STEP.
- ③ DO NOT TIGHTEN ALL SCREWS AND BOLTS UNTIL THE BENCH IS FULLY SET-UP

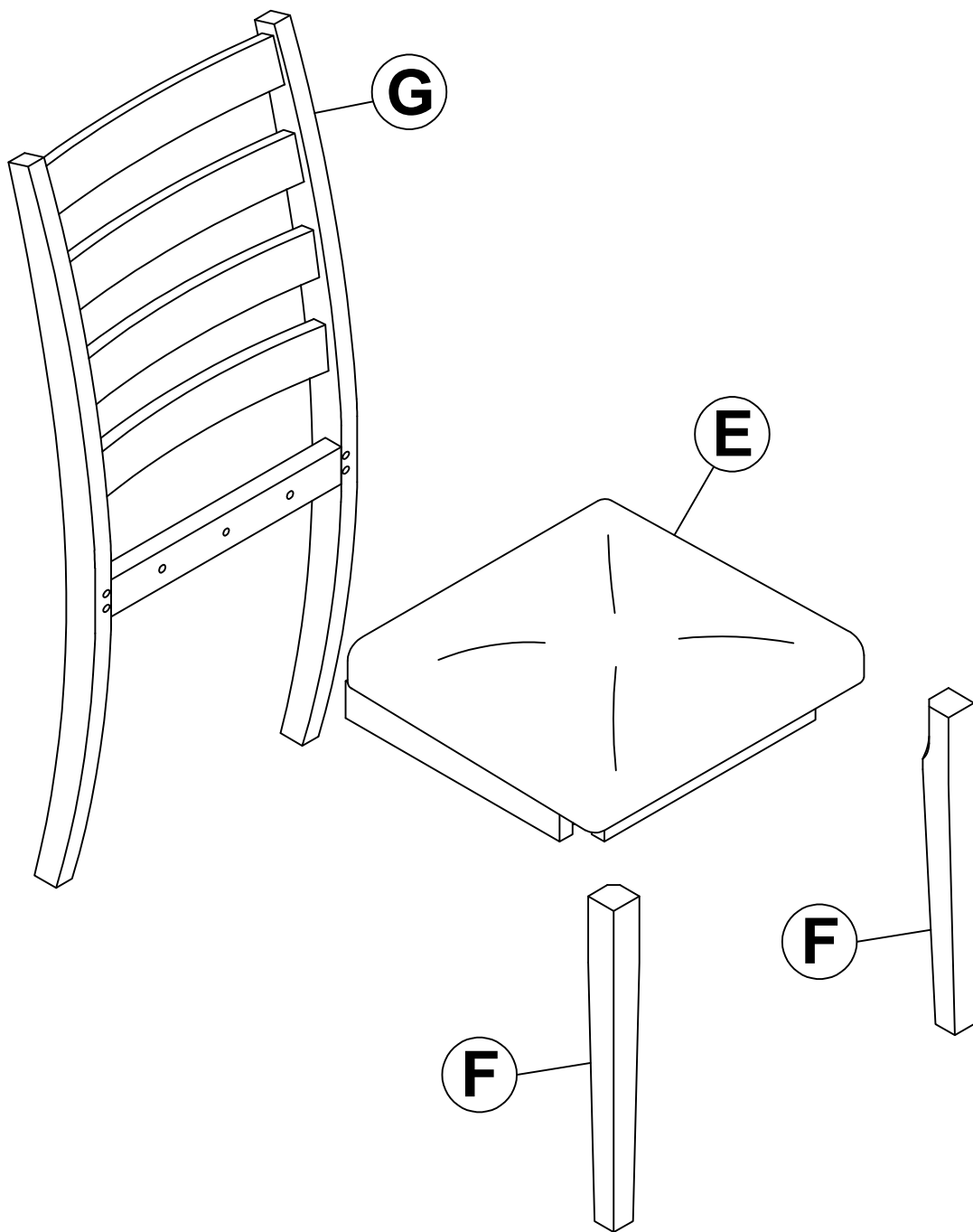

Part List

Hardware List

E

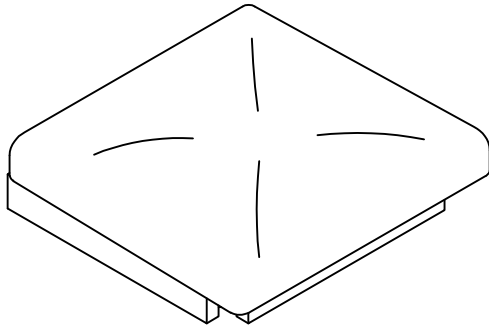

SEAT FRAME (1pc)

F

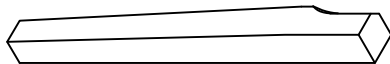

LEGS CHAIR (2pcs)

G

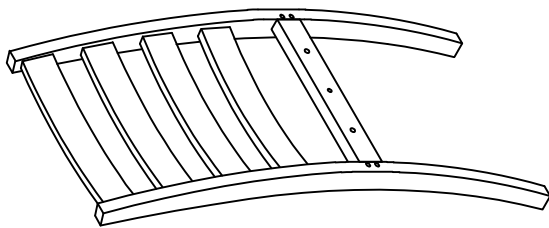

BACK FRAME (1pc)

9



Ø1/4" x 75mm

BOLT (4pcs)

10



Ø1/4" x 55mm

BOLT (4pcs)

11



Ø1/4" x 35mm

BOLT (2pcs)

12



Ø1/4" x 13mm

SPRING WASHER (10pcs)

13

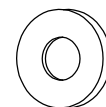

Ø1/4" x 19mm

FLAT WASHER (10pcs)

14



Ø10 x 30mm

WOODEN PEGS (1pc)

15

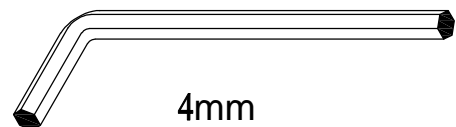

4mm

ALLENKEY (1pc)

Step 1

