

# Instruction Manual

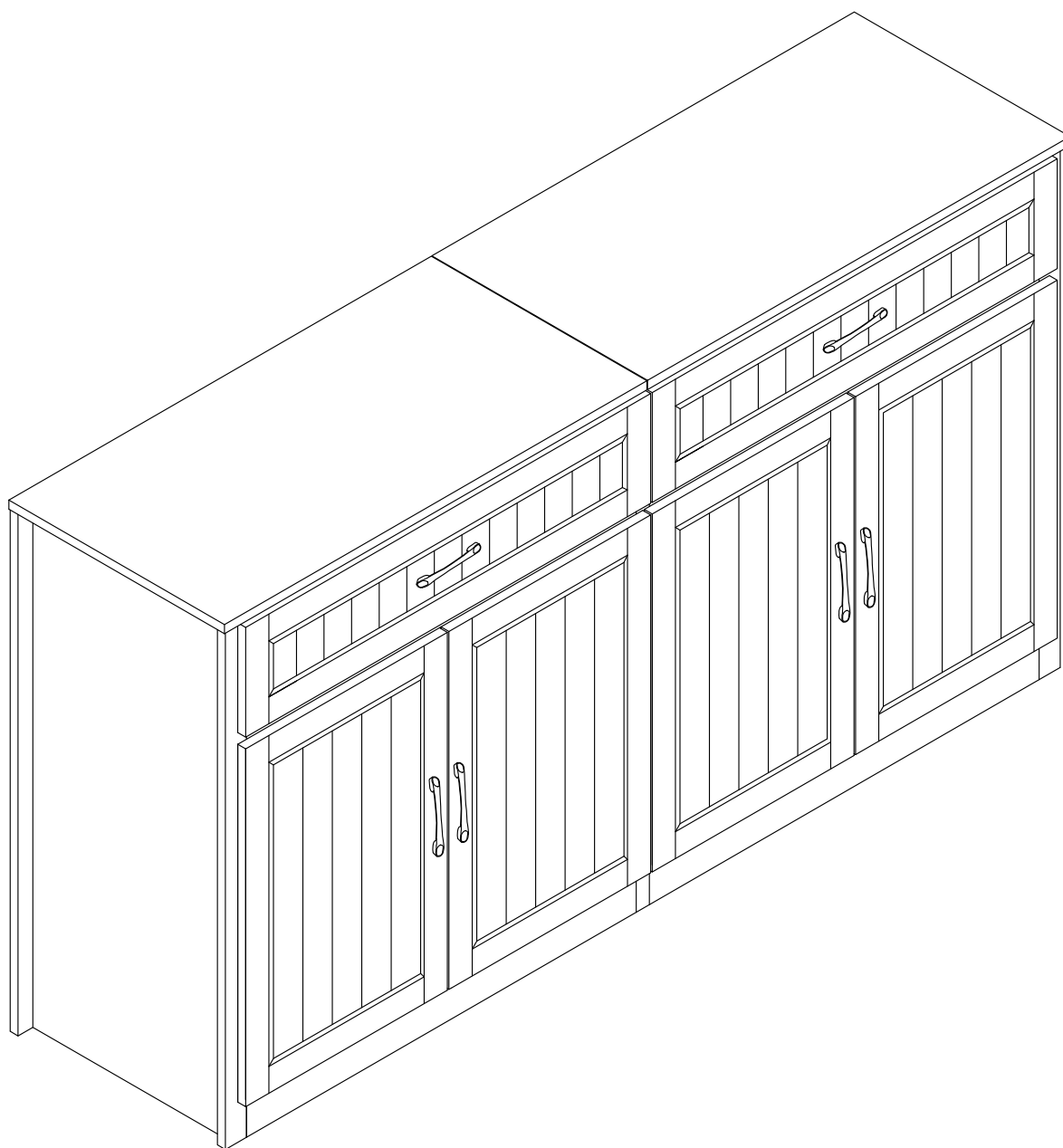

**Storage Cabinet**

**EN**

Thank you for purchase on our products. Please contact us if you have difficulty with assembly or need replacement parts. Our customer service is here to assist you. Please attach your User Name or Order ID so that we can assist you better.

## **WARNING**

Serious or fatal injury may occur from unexpected assembly or use.

1. During the assembly process, keep all parts away from babies or children.
2. Always securely fix this product to the wall. Make sure the wall area to be drilled is free from hidden electrical wires, water and gas pipes.
3. Use of tip-over restraints may only reduce, but not eliminate the risk of tip-over.
4. Unless specially designed to accommodate, do not set heavy objects on top of this product.
5. Place the heaviest items on the lowest shelf.
6. Never allow children to climb or bang on drawers, doors or shelves.

**DE**

Vielen Dank für Ihren Kauf von uns Produkten. Bitte kontaktieren Sie uns, wenn Sie Probleme mit Montage haben oder Ersatzteile benötigen. Wir Kundenservice ist für Sie da. Bitte geben Sie Ihren Benutzernamen oder Ihre Bestellnummer an, damit wir Sie besser unterstützen können.

## **WARNUNG**

Bei unerwarteter Montage oder Verwendung können schwere oder tödliche Verletzung auftreten.

1. Legen Sie in den Montageprozess alle Teile weg von Babys oder Kindern.
2. Stellen Sie sicher, dass der gebohrte Wandbereich frei von verborgenen Stromkabeln, Wasser- und Gasleitungen ist, wenn Sie dieses Produkt an der Wand befestigen.
3. Die Verwendung von Kippsicherungen kann die Gefahr eines Kippens nur verringern, jedoch nicht beseitigen.
4. Setzen Sie bitte keine schweren Gegenstände auf dieses Produkt, es sei denn, dass das Produkt speziell für die Unterbringung konzipiert wird.
5. Legen Sie bitte die schwersten Gegenstände auf das unterste Regal.
6. Erlauben Sie nie Kindern, auf Schubladen, Türen oder Regale zu klettern oder zu knallen.



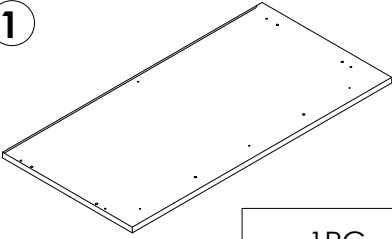
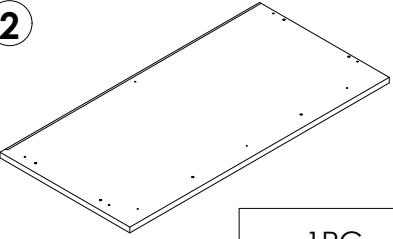
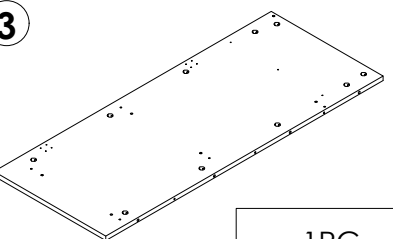
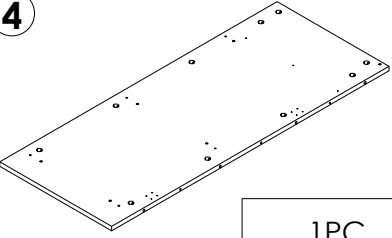
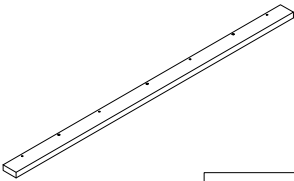
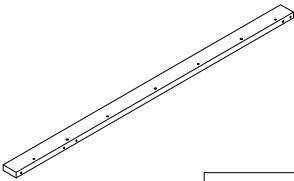
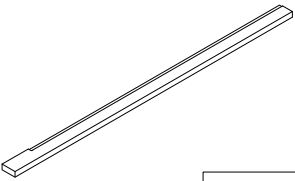
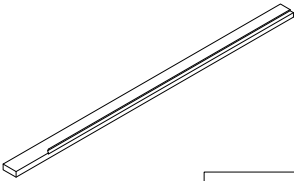
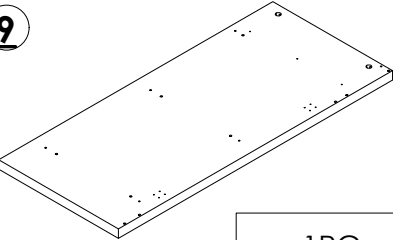
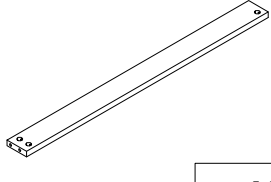
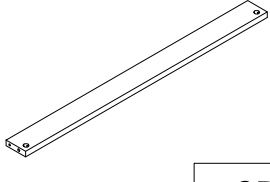
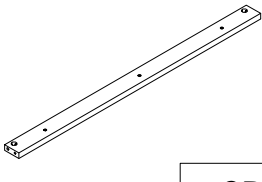
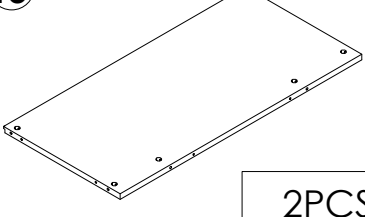
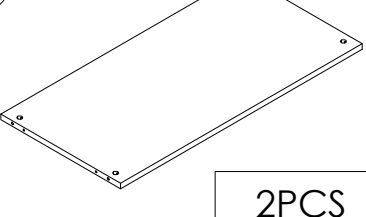
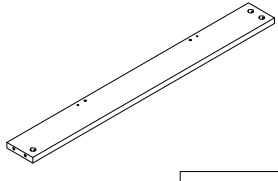
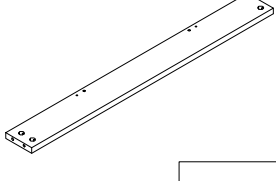
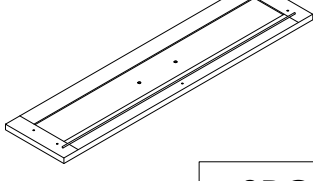
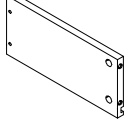
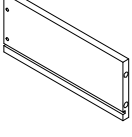
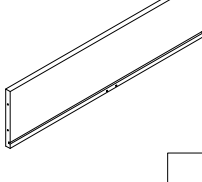
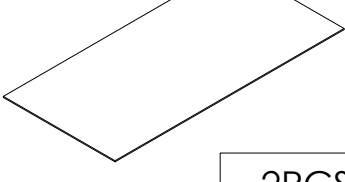

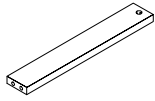
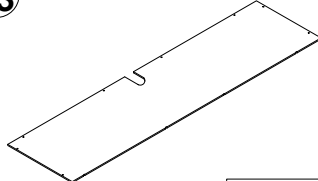
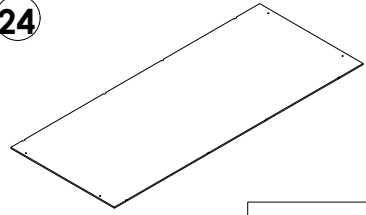
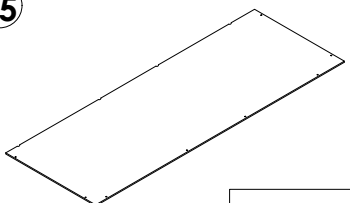
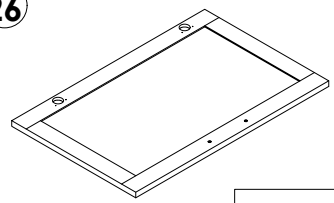
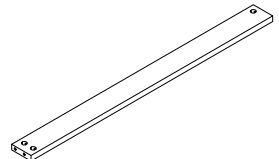

## Parts List(EN) / Teile Liste(DE)

<p style="text-align: center;"><b>1</b></p>  <p style="text-align: right;">1PC</p>	<p style="text-align: center;"><b>2</b></p>  <p style="text-align: right;">1PC</p>	<p style="text-align: center;"><b>3</b></p>  <p style="text-align: right;">1PC</p>
<p style="text-align: center;"><b>4</b></p>  <p style="text-align: right;">1PC</p>	<p style="text-align: center;"><b>5</b></p>  <p style="text-align: right;">1PC</p>	<p style="text-align: center;"><b>6</b></p>  <p style="text-align: right;">1PC</p>
<p style="text-align: center;"><b>7</b></p>  <p style="text-align: right;">1PC</p>	<p style="text-align: center;"><b>8</b></p>  <p style="text-align: right;">1PC</p>	<p style="text-align: center;"><b>9</b></p>  <p style="text-align: right;">1PC</p>
<p style="text-align: center;"><b>10</b></p>  <p style="text-align: right;">1PC</p>	<p style="text-align: center;"><b>11</b></p>  <p style="text-align: right;">2PCS</p>	<p style="text-align: center;"><b>12</b></p>  <p style="text-align: right;">2PCS</p>
<p style="text-align: center;"><b>13</b></p>  <p style="text-align: right;">2PCS</p>	<p style="text-align: center;"><b>14</b></p>  <p style="text-align: right;">2PCS</p>	<p style="text-align: center;"><b>15</b></p>  <p style="text-align: right;">1PC</p>
<p style="text-align: center;"><b>16</b></p>  <p style="text-align: right;">1PC</p>	<p style="text-align: center;"><b>17</b></p>  <p style="text-align: right;">2PCS</p>	<p style="text-align: center;"><b>18</b></p>  <p style="text-align: right;">2PCS</p>
<p style="text-align: center;"><b>19</b></p>  <p style="text-align: right;">2PCS</p>	<p style="text-align: center;"><b>20</b></p>  <p style="text-align: right;">2PCS</p>	<p style="text-align: center;"><b>21</b></p>  <p style="text-align: right;">2PCS</p>

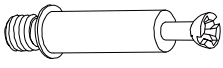
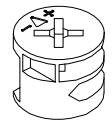
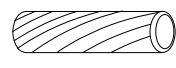
# Parts List(EN) / Teile Liste(DE)

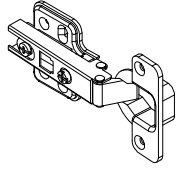
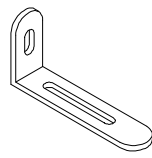
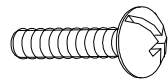
<p><b>22</b></p>  <p>2PCS</p>	<p><b>23</b></p>  <p>2PCS</p>	<p><b>24</b></p>  <p>2PCS</p>
<p><b>25</b></p>  <p>2PCS</p>	<p><b>26</b></p>  <p>4PCS</p>	<p><b>27</b></p>  <p>1PC</p>

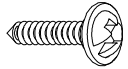
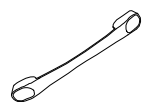
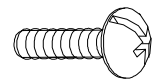
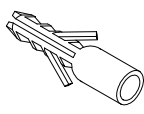
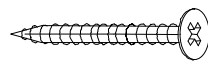
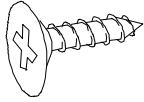

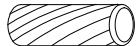
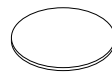
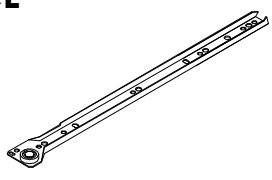
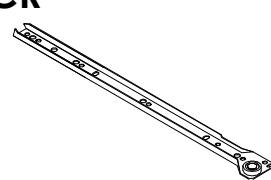
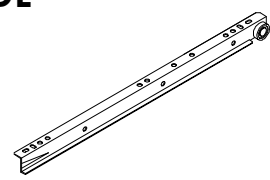
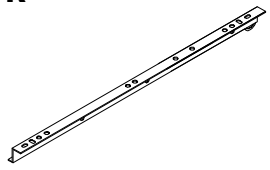
## Parts List(EN) / Teile Liste(DE)

<p><b>A</b></p>  <p>M6×35mm    74+2PCS</p>	<p><b>B</b></p>  <p>∅15×10mm    74+2PCS</p>	<p><b>C</b></p>  <p>∅6×30mm    52+2PCS</p>	<p><b>D</b></p>  <p>M4×14mm    48+2PCS</p>
<p><b>E</b></p>  <p>∅35mm    8PCS</p>	<p><b>F</b></p>  <p>2PCS</p>	<p><b>G</b></p>  <p>M4×16mm    8+1PCS</p>	<p><b>H</b></p>  <p>M4×20mm    6PCS</p>
<p><b>I</b></p>  <p>M3×12mm    56+2PCS</p>	<p><b>J</b></p>  <p>6PCS</p>	<p><b>K</b></p>  <p>M4×12mm    4PCS</p>	<p><b>L</b></p>  <p>M6×30mm    2PCS</p>
<p><b>M</b></p>  <p>M4×35mm    14+1PCS</p>	<p><b>N</b></p>  <p>M3.5×12mm    24+2PCS</p>	<p><b>O</b></p>  <p>M4×12mm    2PCS</p>	<p><b>P</b></p>  <p>∅6×20mm    4PCS</p>
<p><b>Q</b></p>  <p>16+2PCS</p>	<p><b>CL</b></p>  <p>L350mm    2PCS</p>	<p><b>CR</b></p>  <p>L350mm    2PCS</p>	<p><b>DL</b></p>  <p>L350mm    2PCS</p>
<p><b>DR</b></p>  <p>L350mm    2PCS</p>			

# Assembly Steps(EN) / Montageschritte(DE)

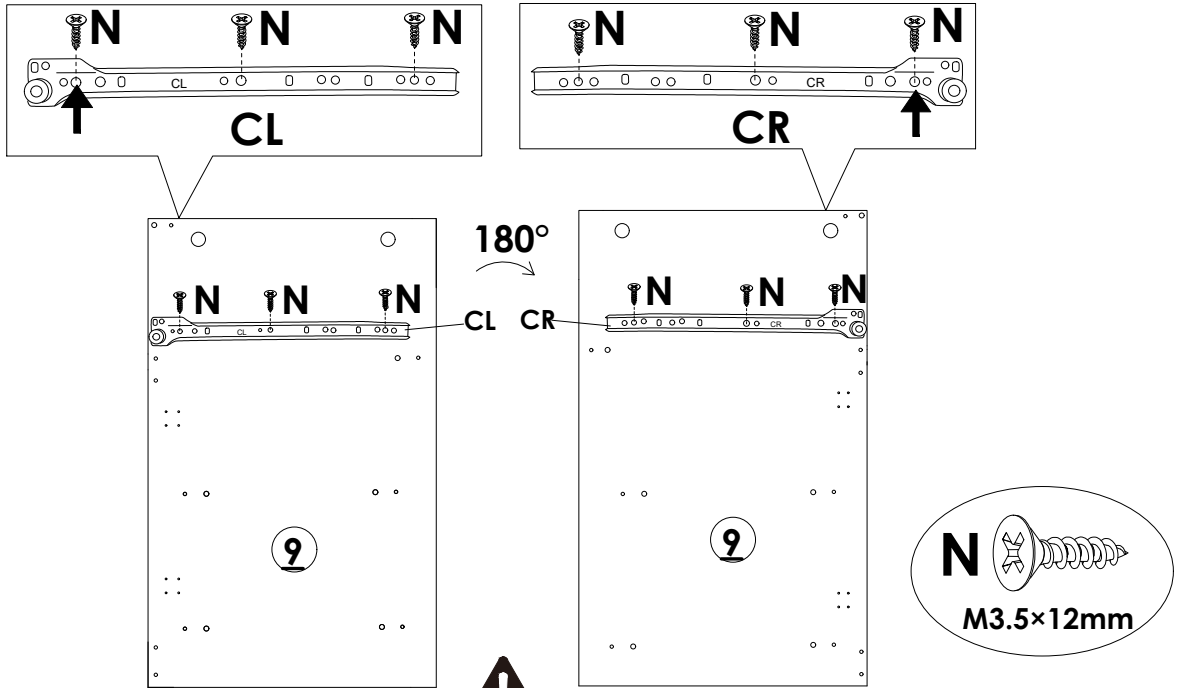
## STEP 1



	<b>N x 6PCS</b>
	<b>CL x 1PC</b>
	<b>CR x 1PC</b>

Turn over part 9 to install the other side.

## STEP 2

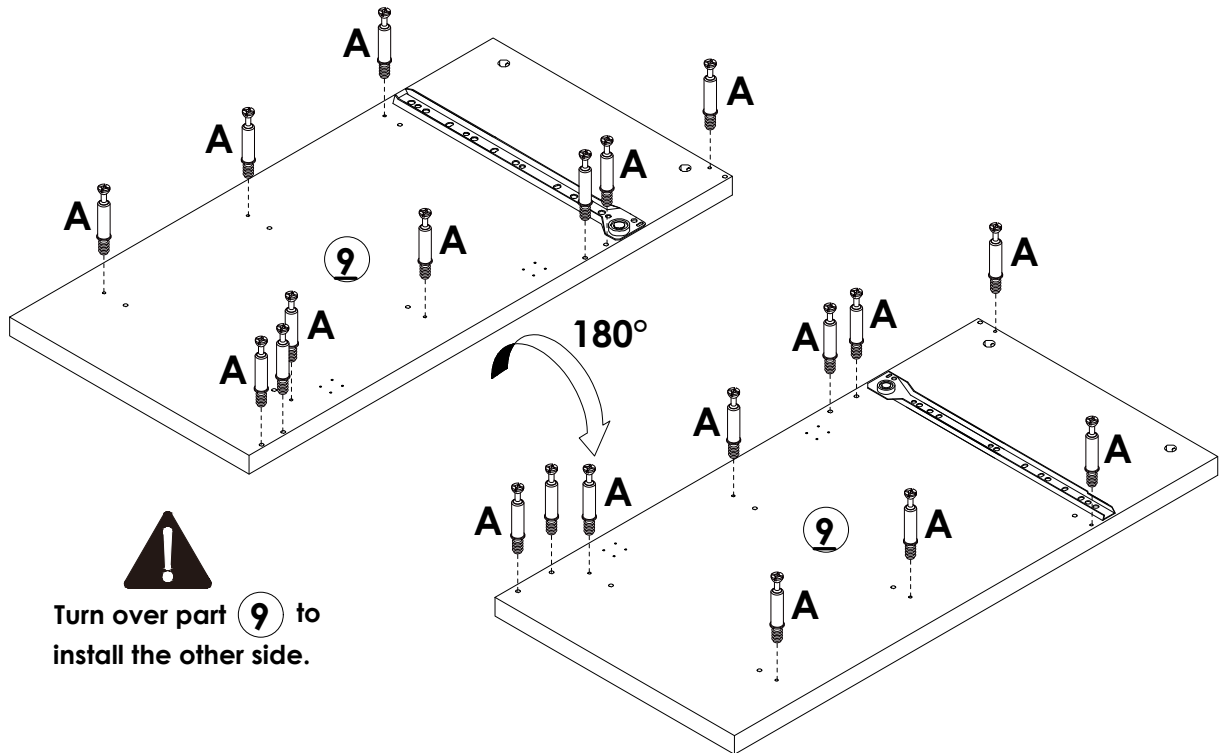

Turn over part 9 to install the other side.

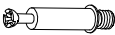
	<b>A x 20PCS</b>
---	------------------

# Assembly Steps(EN) / Montageschritte(DE)

## STEP 3

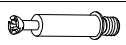
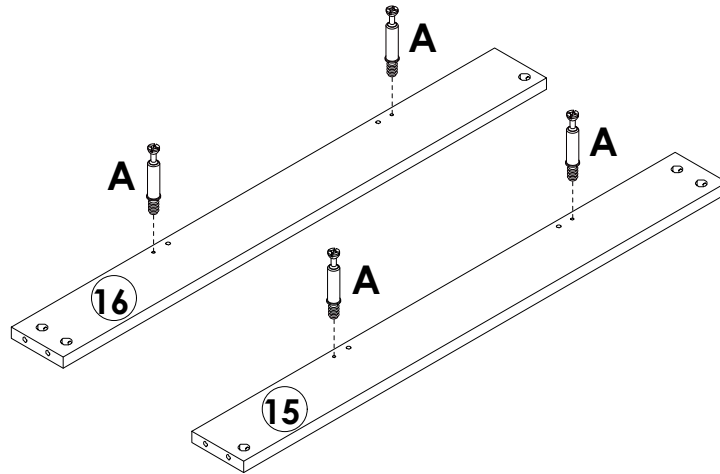

**A** x 4PCS

## STEP 4

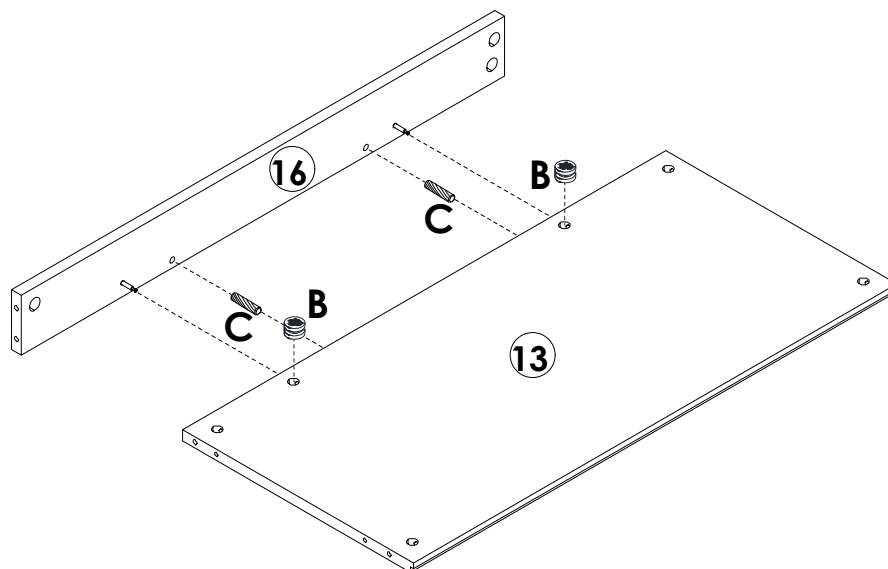

**B** x 2PCS



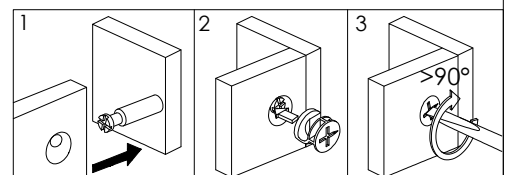

**C** x 2PCS

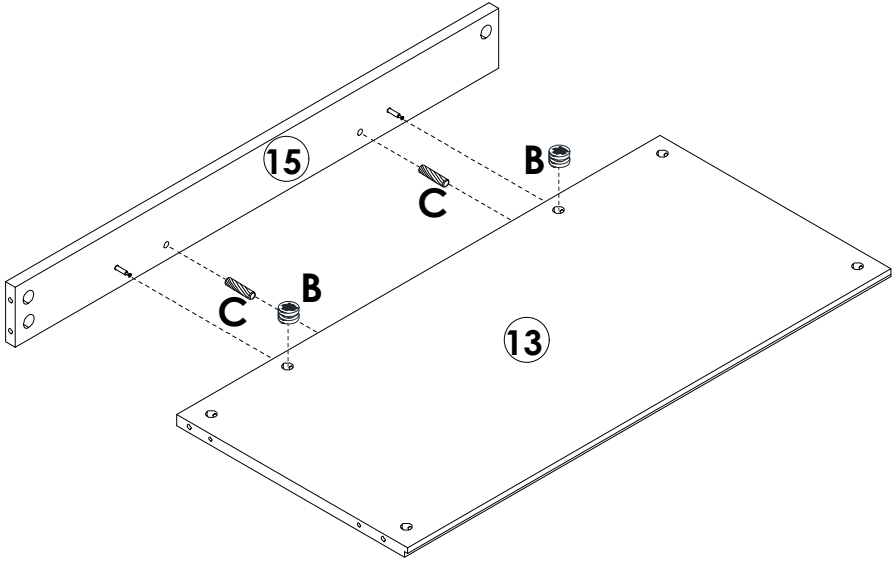

# Assembly Steps(EN) / Montageschritte(DE)

## STEP 5



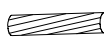

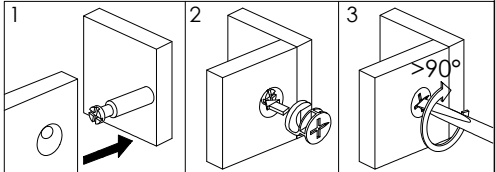
	<b>B</b> x 2PCS
	<b>C</b> x 2PCS

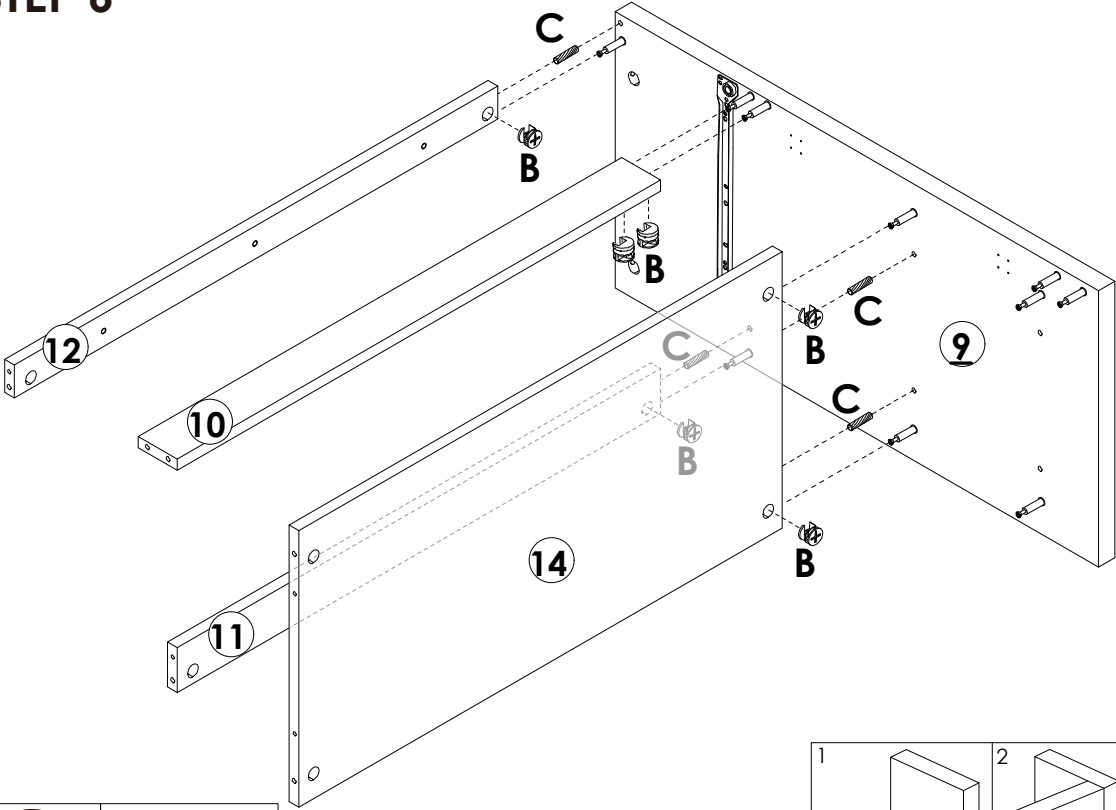

## STEP 6



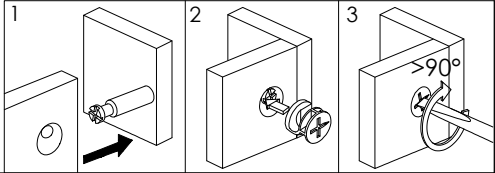

	<b>B</b> x 6PCS
	<b>C</b> x 4PCS

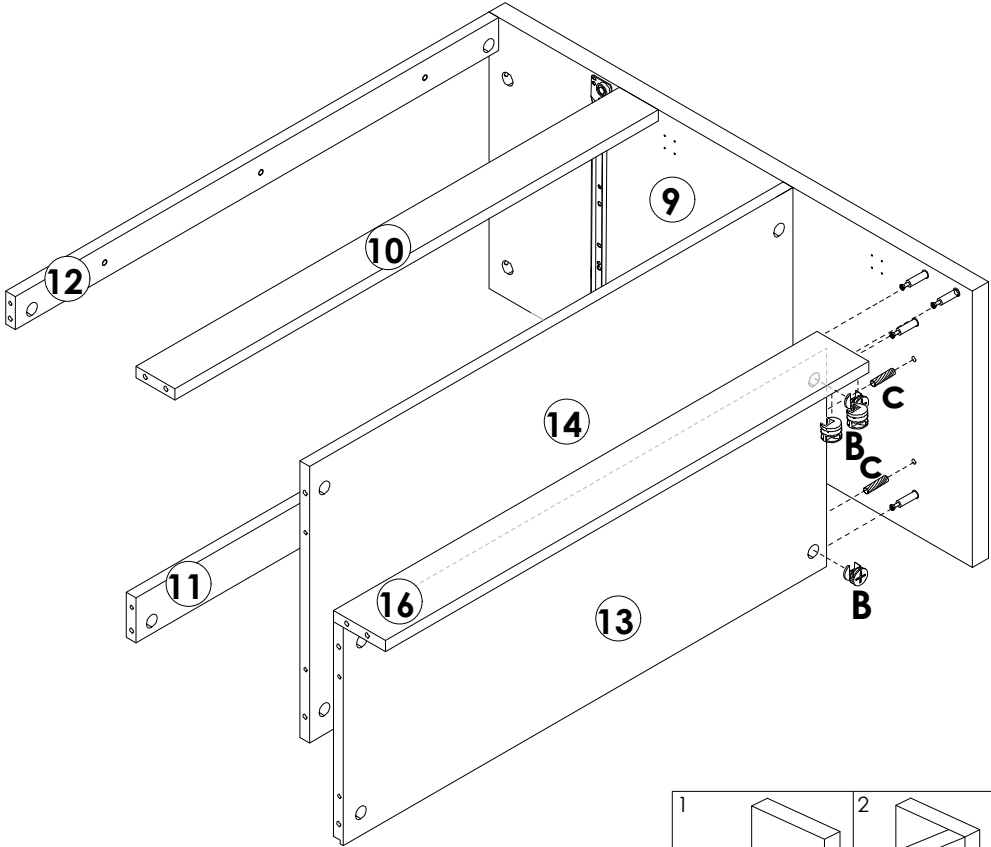

# Assembly Steps(EN) / Montageschritte(DE)

## STEP 7



	<b>B</b> x 4PCS
	<b>C</b> x 2PCS

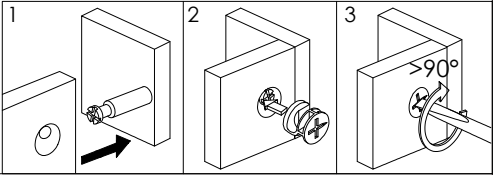

## STEP 8

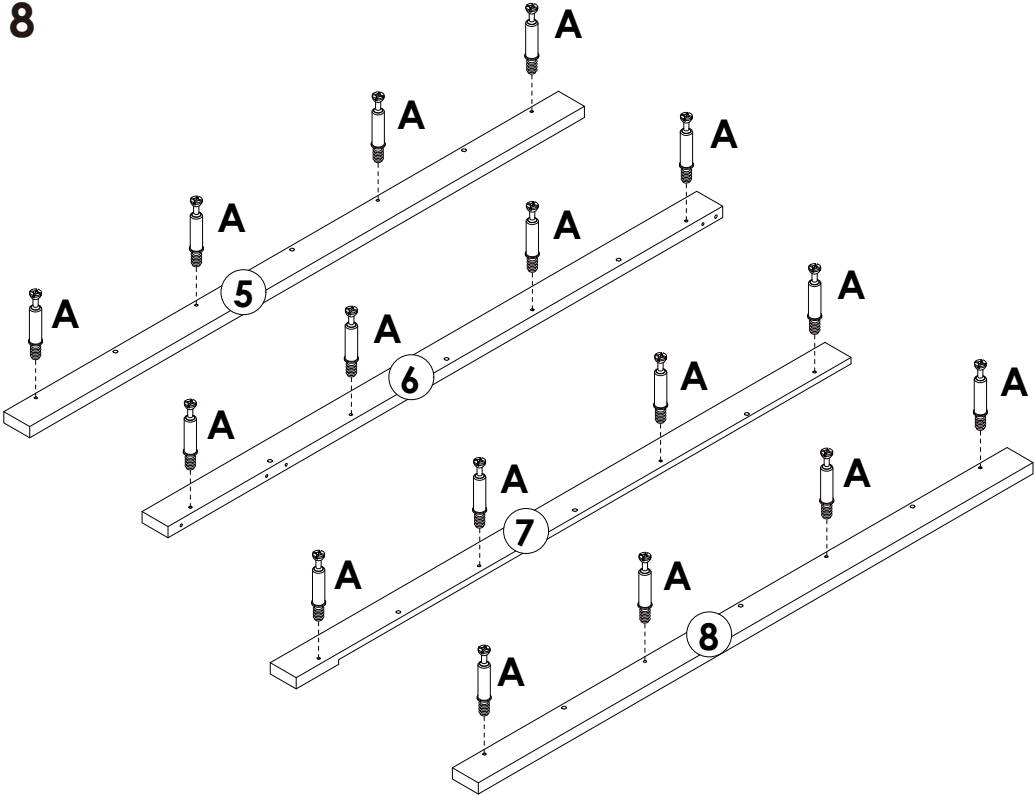

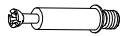

	<b>A</b> x 16PCS
---	------------------

# Assembly Steps(EN) / Montageschritte(DE)

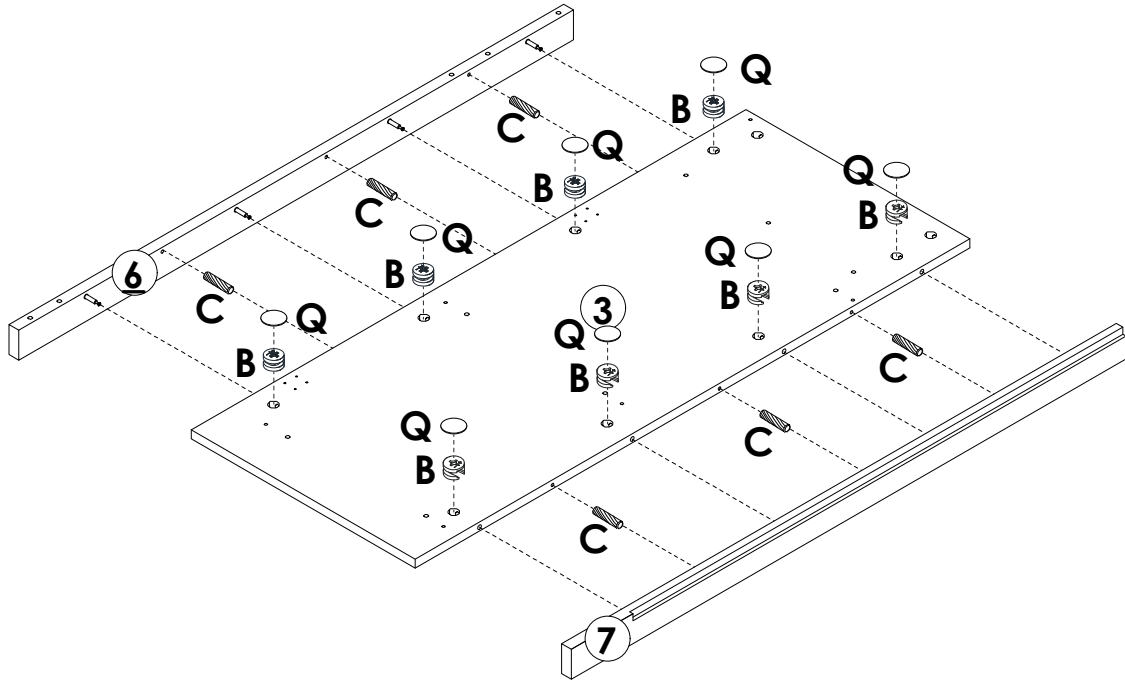
## STEP 9



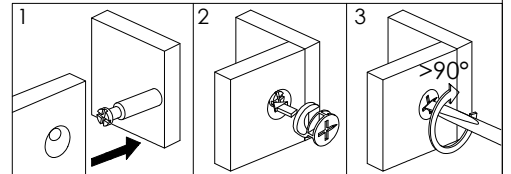

	<b>B</b> x 8PCS
	<b>C</b> x 6PCS
	<b>Q</b> x 8PCS

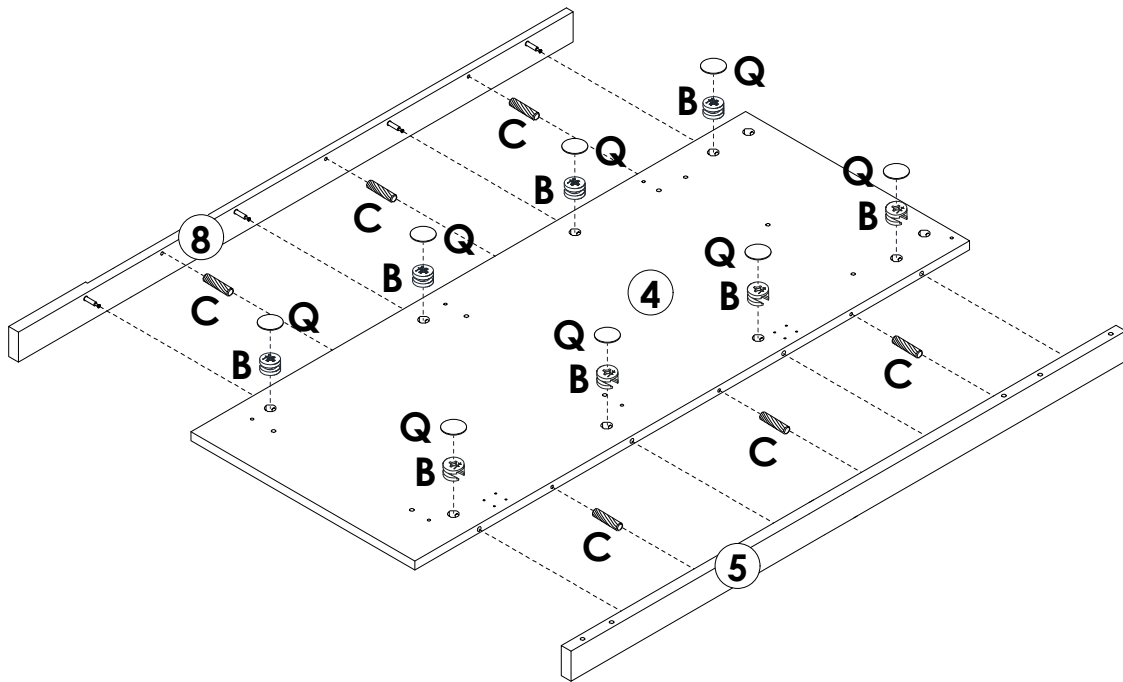

## STEP 10





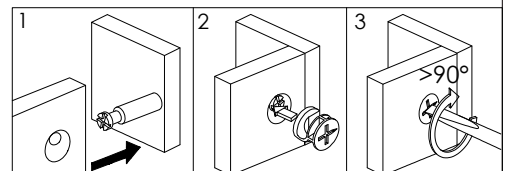

	<b>B</b> x 8PCS
	<b>C</b> x 6PCS
	<b>Q</b> x 8PCS

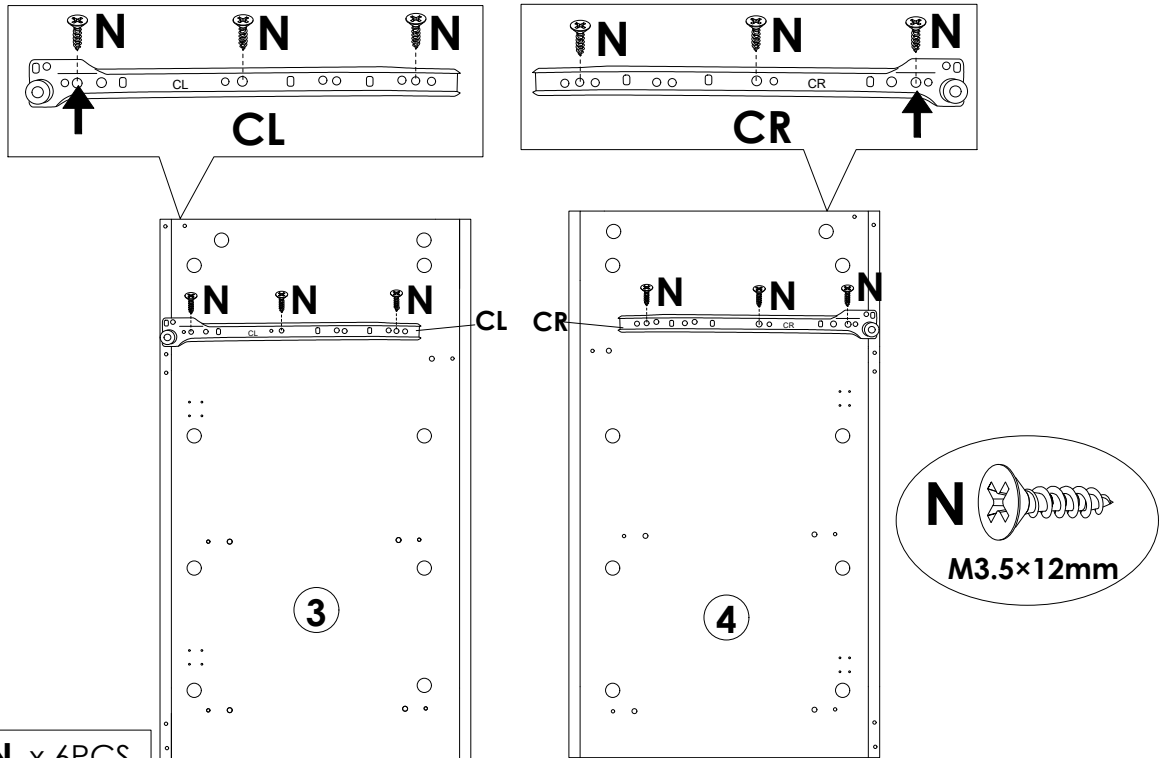

# Assembly Steps(EN) / Montageschritte(DE)

## STEP 11



	<b>N x 6PCS</b>
	<b>CL x 1PC</b>
	<b>CR x 1PC</b>

## STEP 12

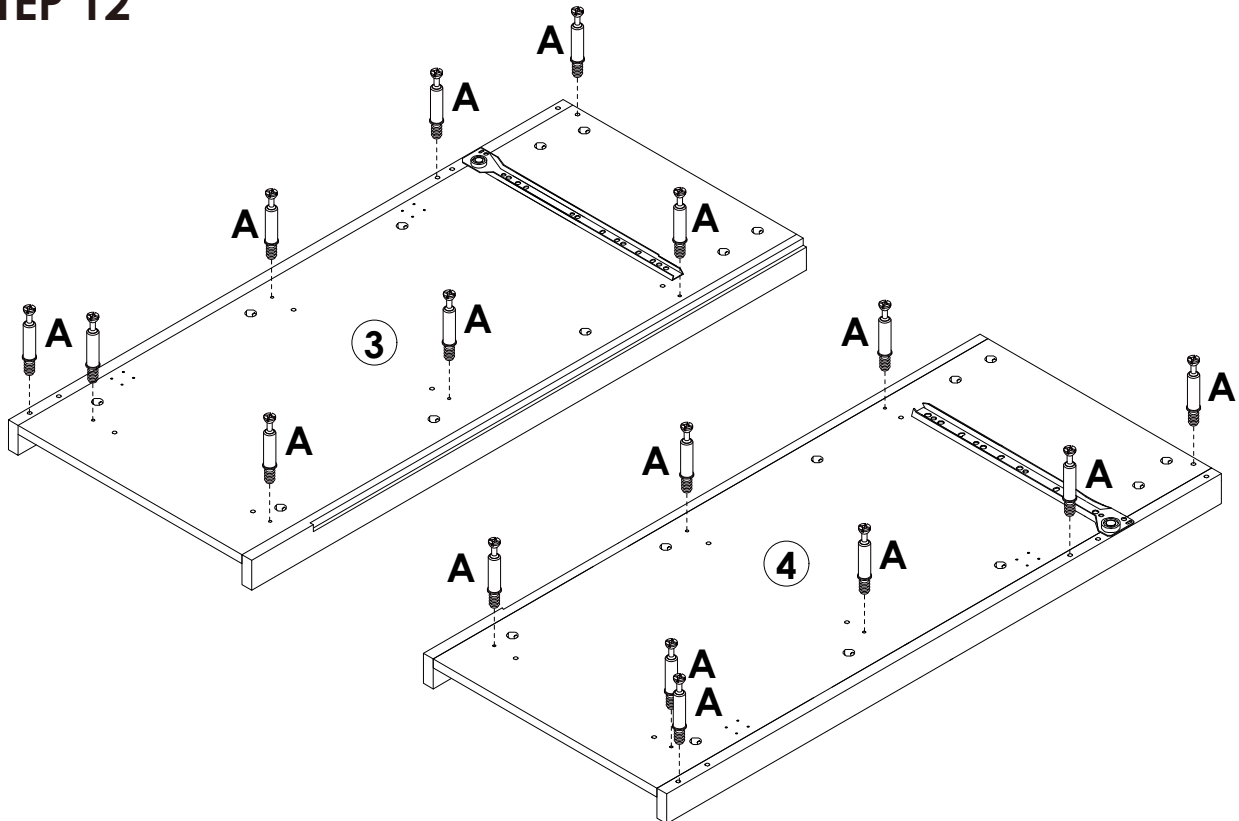

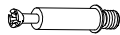
	<b>A x 16PCS</b>
---	------------------

# Assembly Steps(EN) / Montageschritte(DE)

## STEP 13

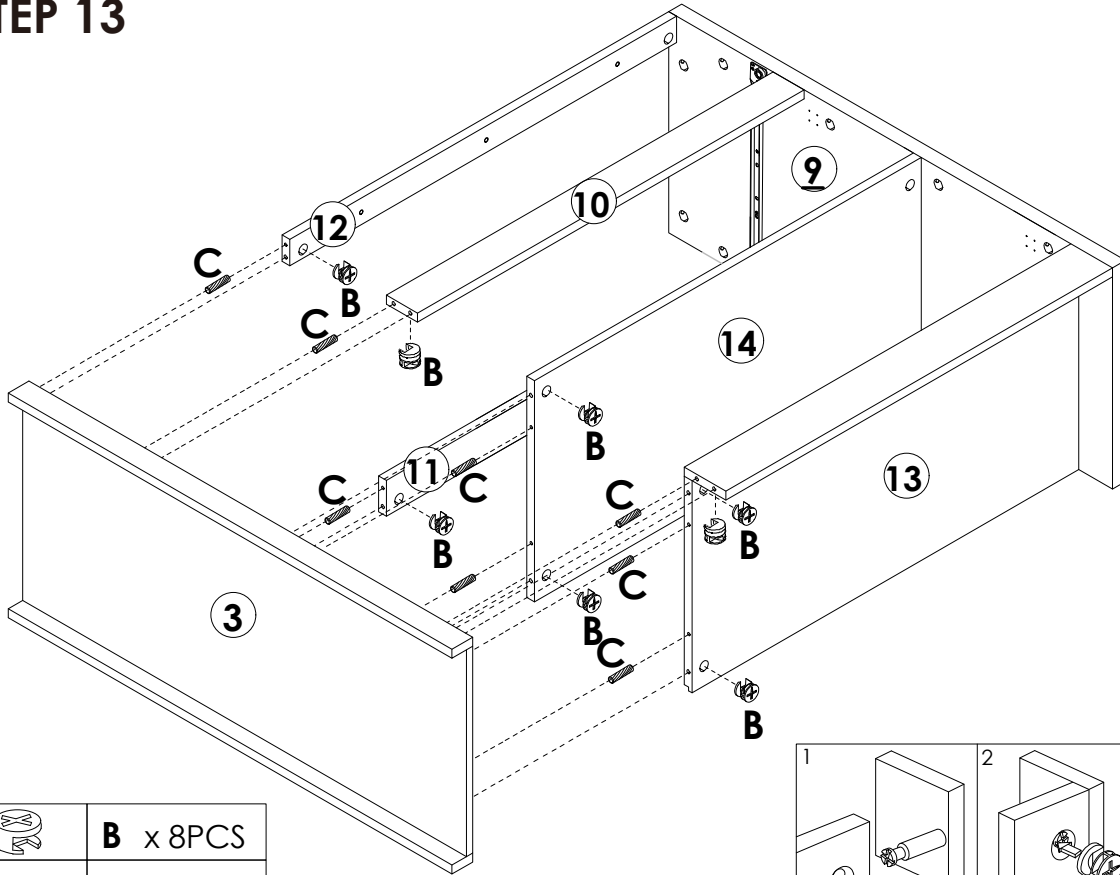

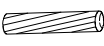

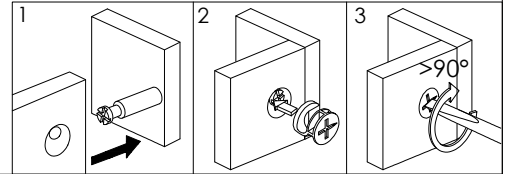
	<b>B</b> x 8PCS
	<b>C</b> x 8PCS

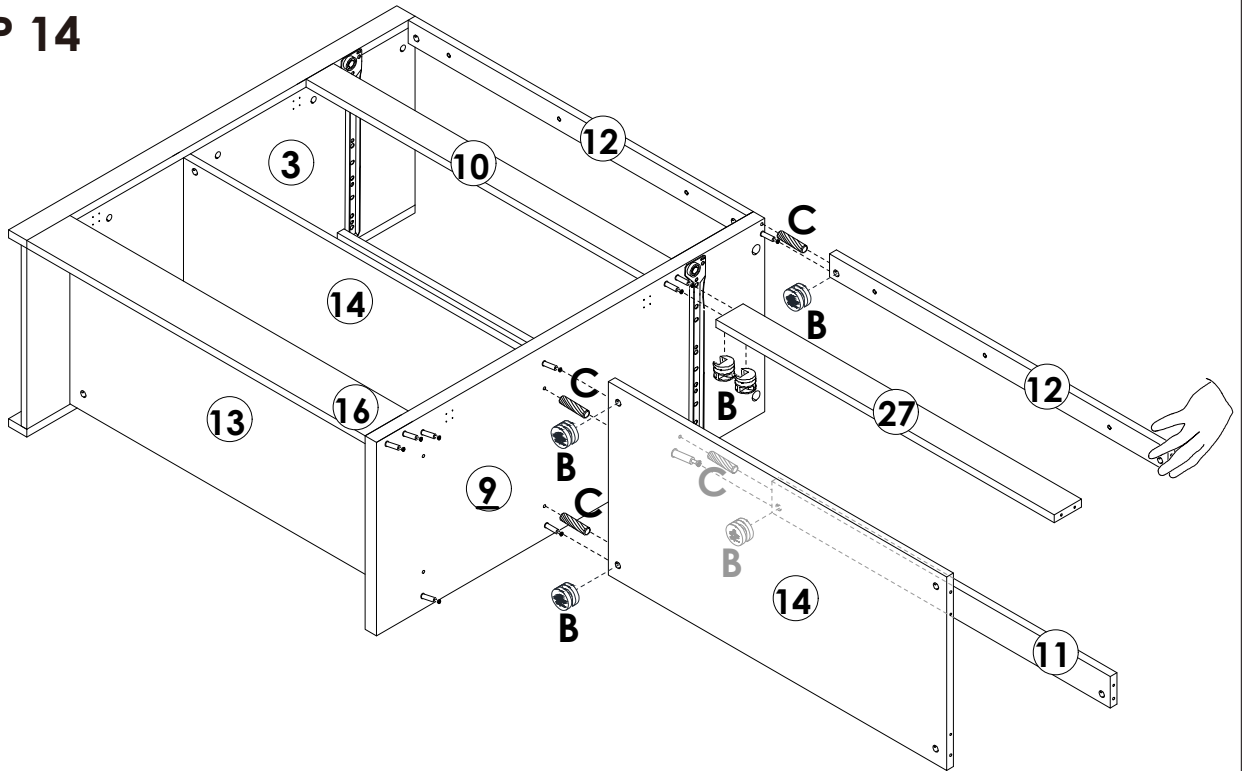

## STEP 14



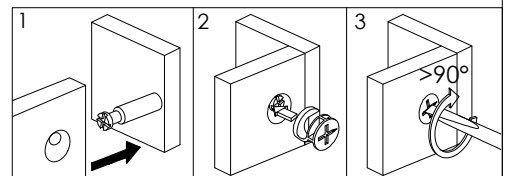

	<b>B</b> x 6PCS
	<b>C</b> x 4PCS

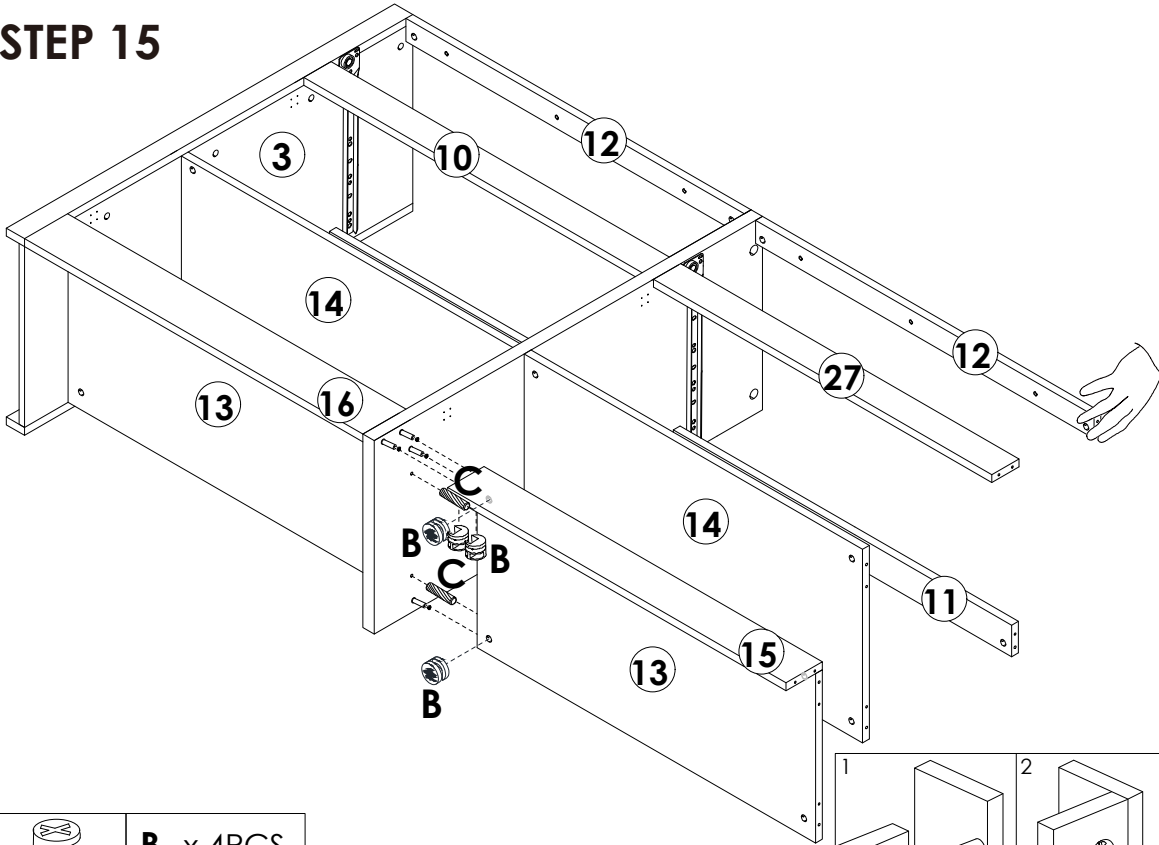

# Assembly Steps(EN) / Montageschritte(DE)

## STEP 15



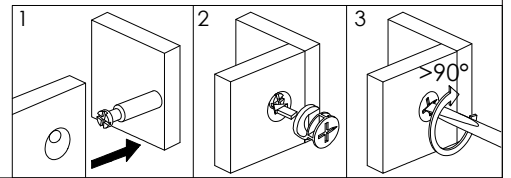

	<b>B</b> x 4PCS
	<b>C</b> x 2PCS

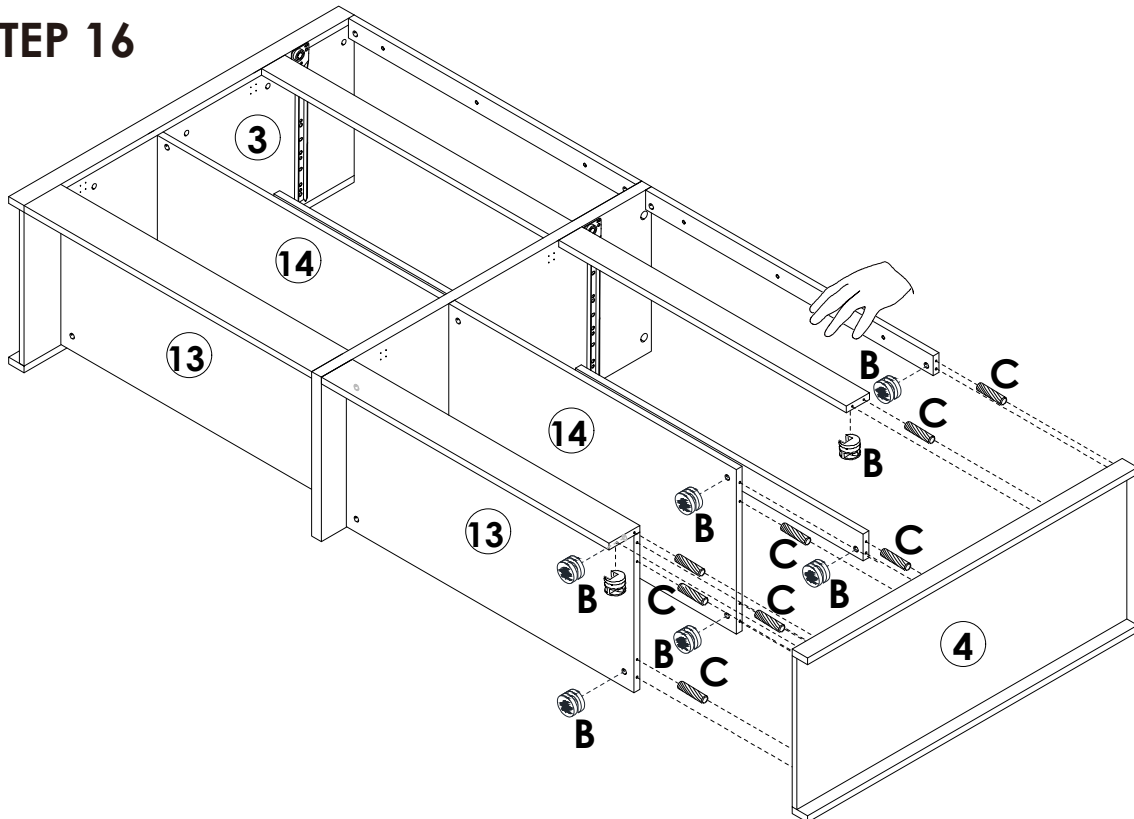

## STEP 16



	<b>B</b> x 8PCS
	<b>C</b> x 8PCS

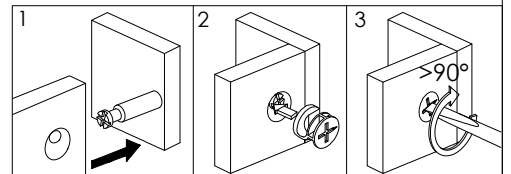



# Assembly Steps(EN) / Montageschritte(DE)

## STEP 17

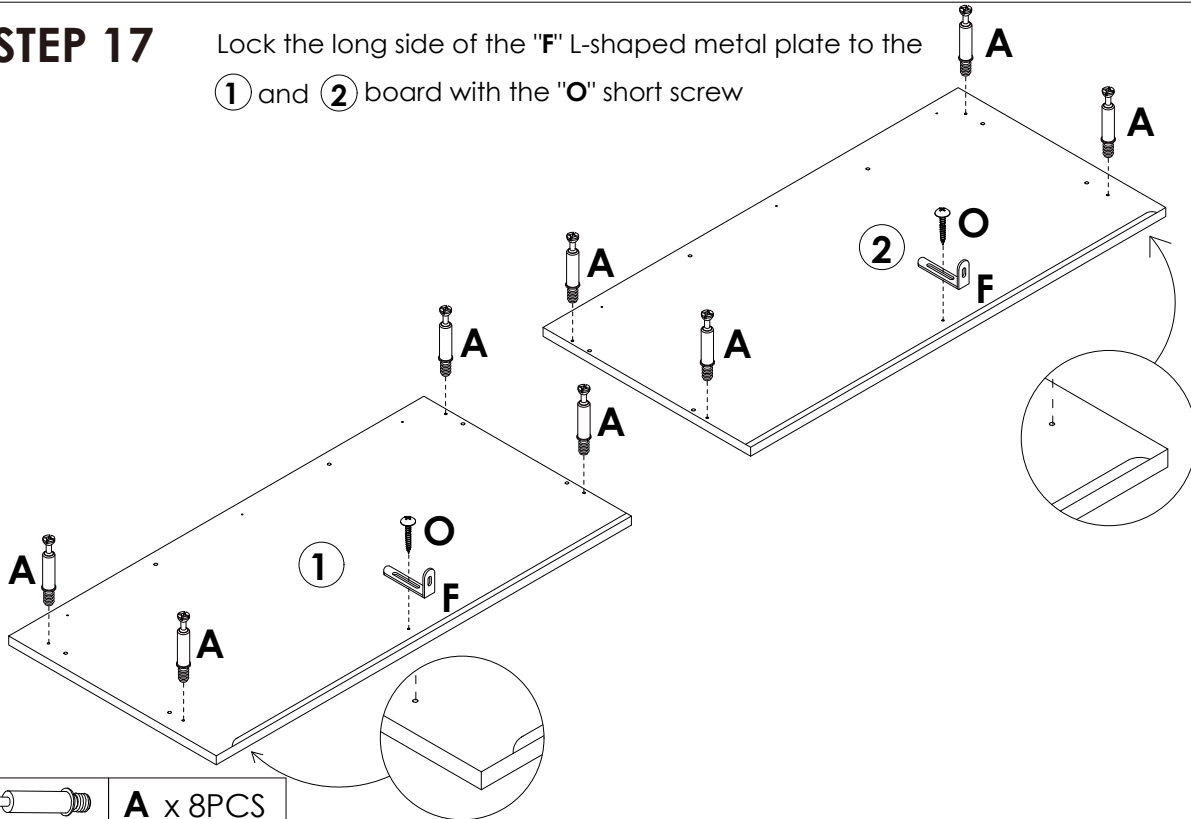
Lock the long side of the "F" L-shaped metal plate to the  
 ① and ② board with the "O" short screw

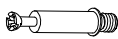

	<b>A</b> x 8PCS		<b>F</b> x 2PCS		<b>O</b> x 2PCS
---	-----------------	---	-----------------	---	-----------------





## STEP 18

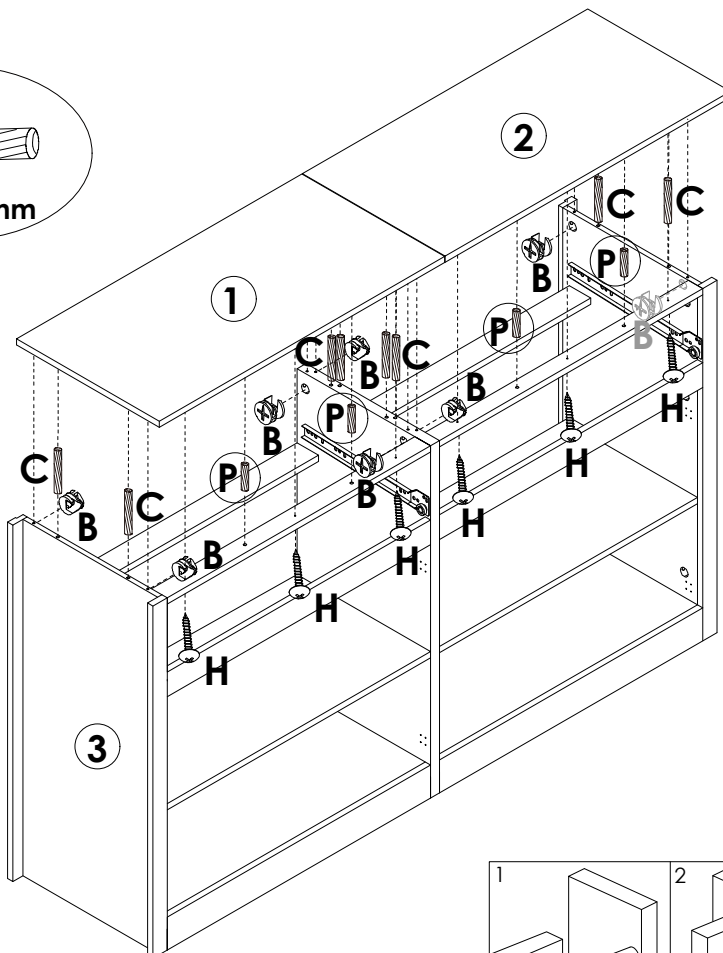

**P**

Ø6×20mm



	<b>B</b> x 8PCS
	<b>C</b> x 8PCS
	<b>H</b> x 6PCS
	<b>P</b> x 4PCS

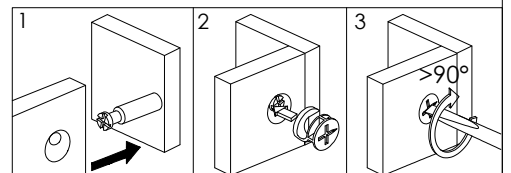

# Assembly Steps(EN) / Montageschritte(DE)

## STEP 19

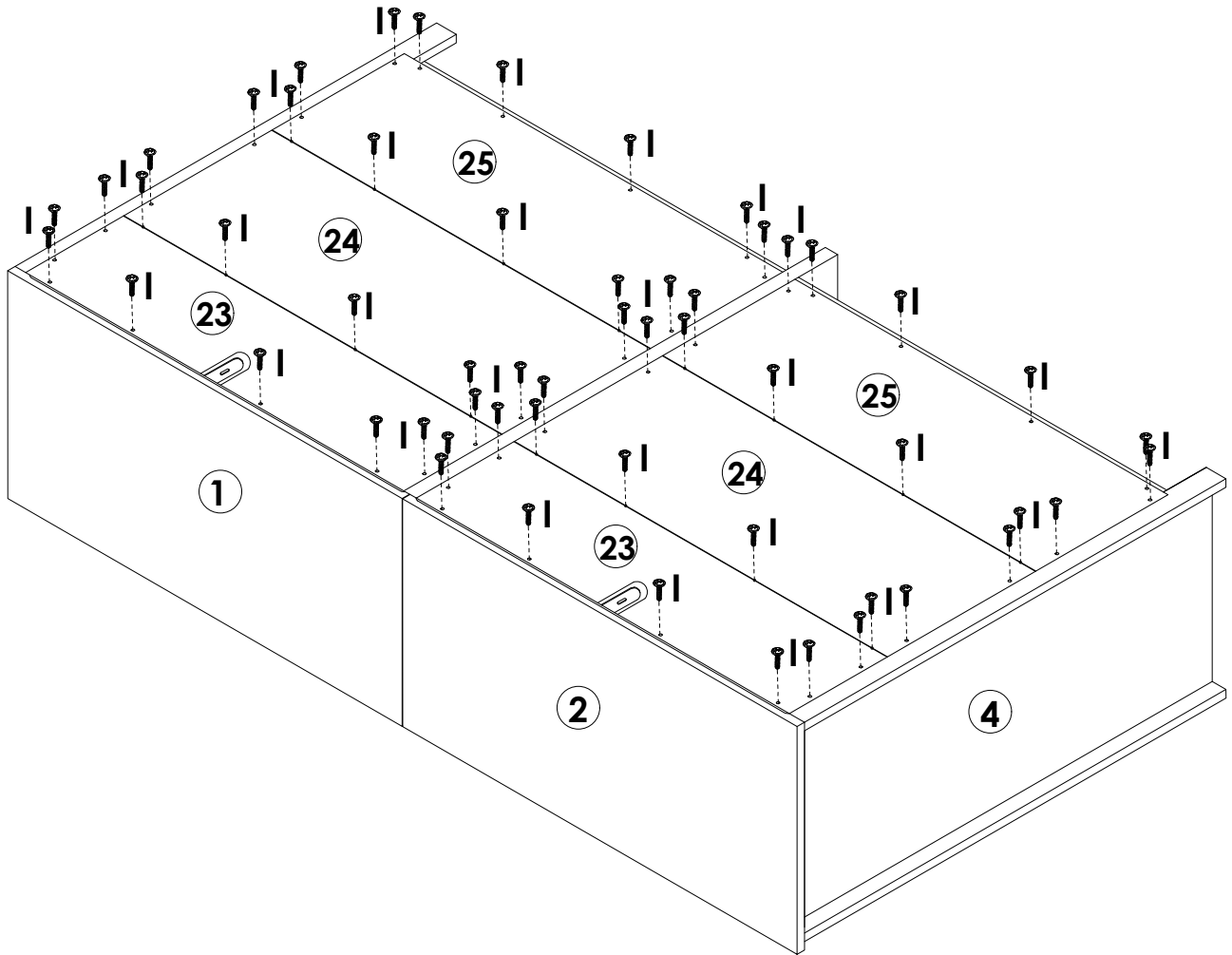

I x 56PCS

## Assembly Steps(EN) / Montageschritte(DE)

### STEP 20

Drill 2 holes on the wall at the required position for anti-falling device installation.

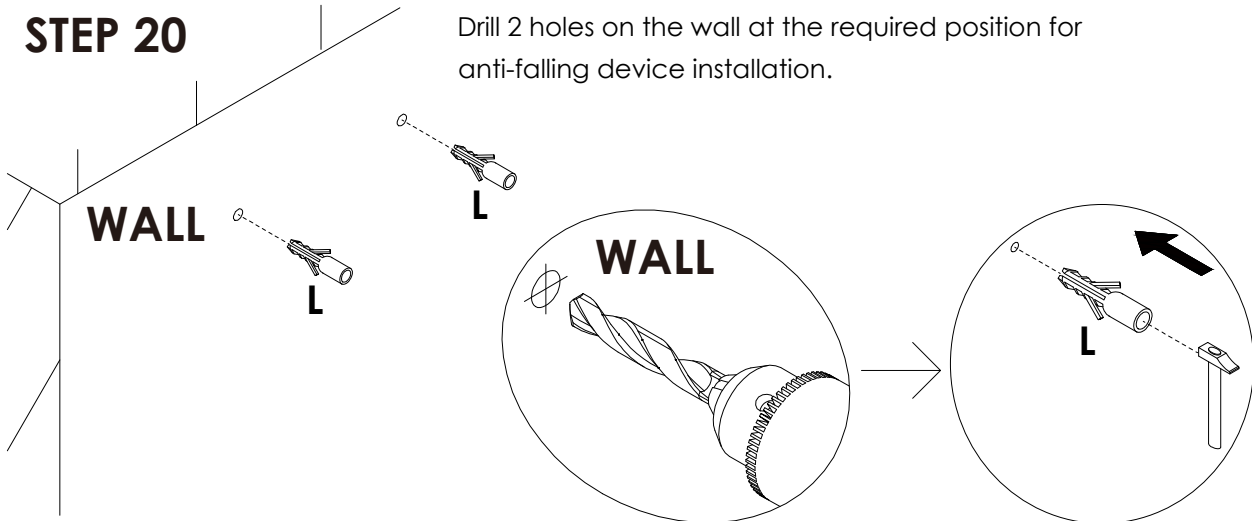

**L** x 2PCS

### STEP 21

Move the cabinet to the required position, use the "M" long screw to fix the cabinet to the wall.

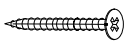
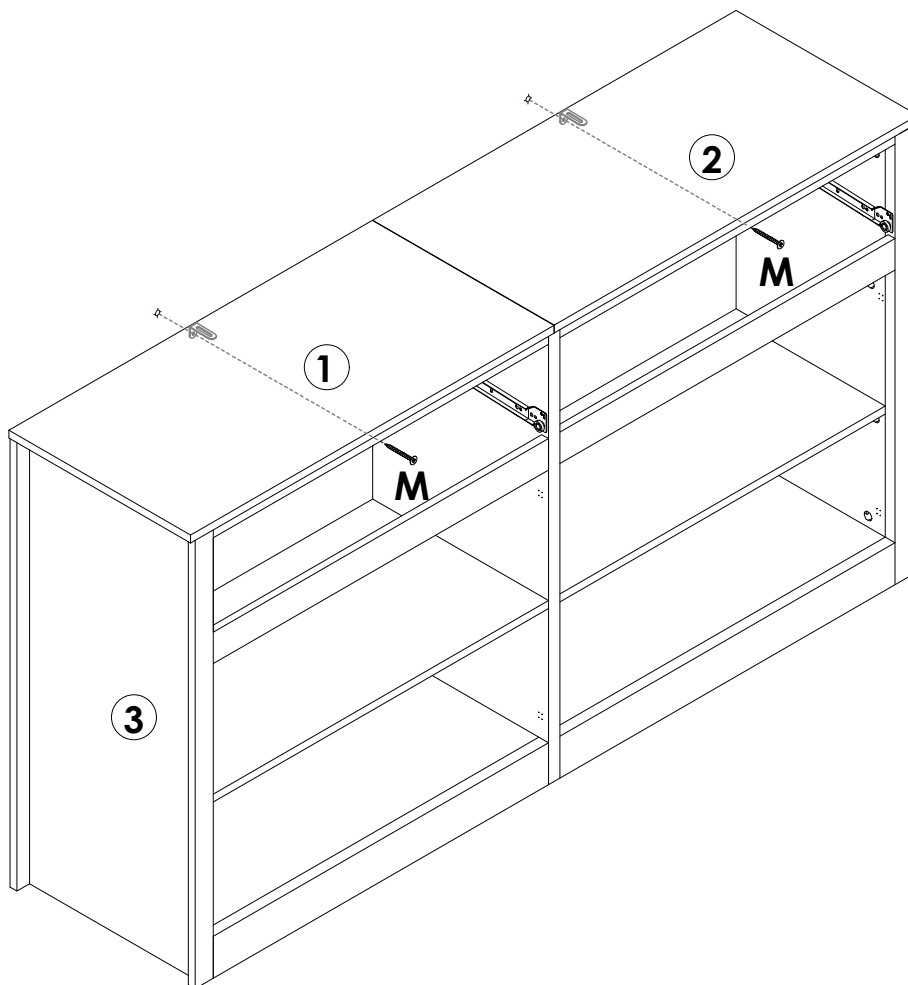



**M** x 2PCS

# Assembly Steps(EN) / Montageschritte(DE)

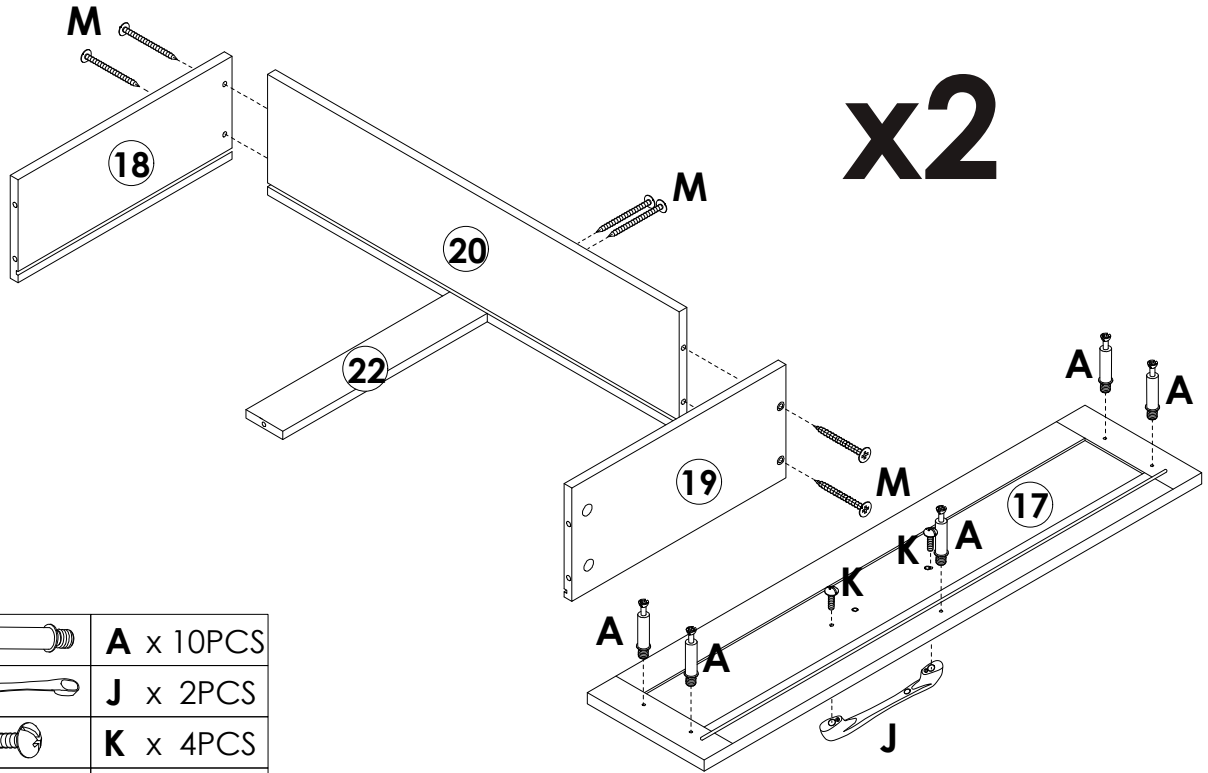
## STEP 22

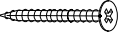

**x2**

	<b>A</b> x 10PCS
	<b>J</b> x 2PCS
	<b>K</b> x 4PCS
	<b>M</b> x 12PCS

## STEP 23

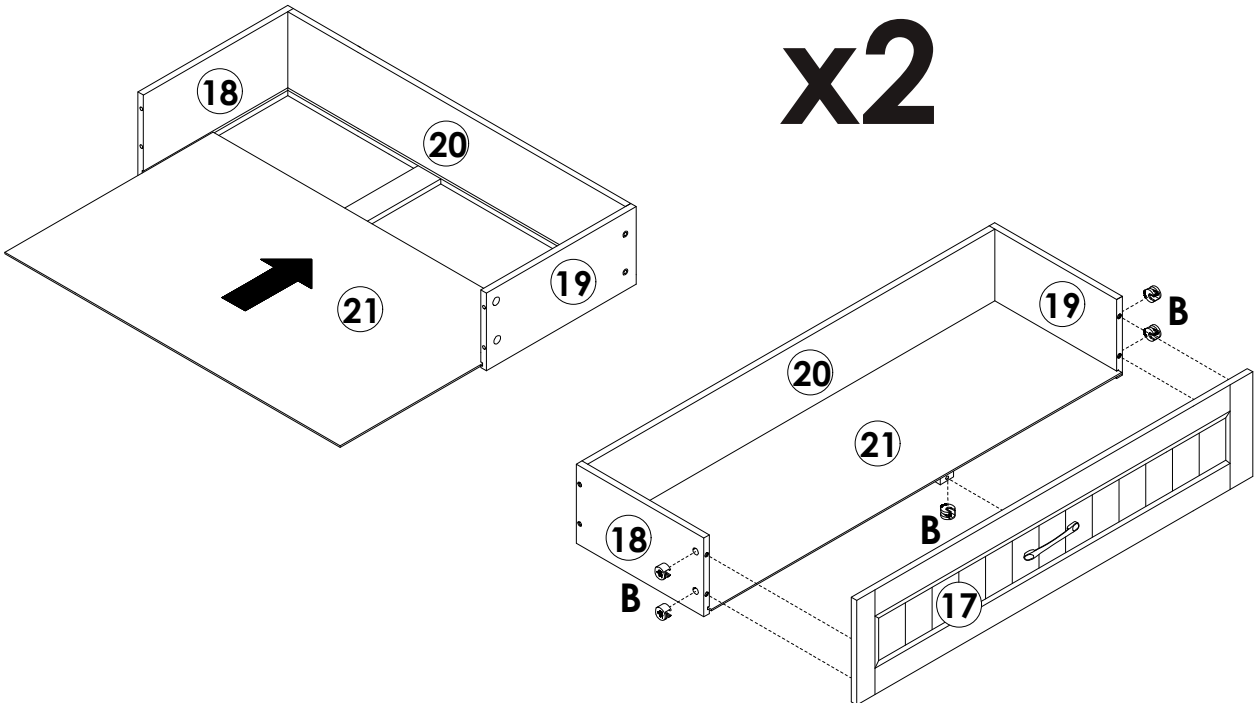

**x2**

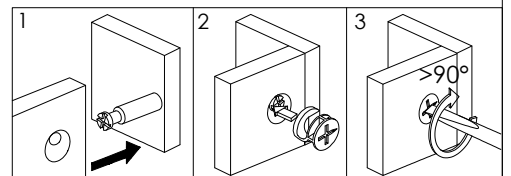

	<b>B</b> x 10PCS
---	------------------



# Assembly Steps(EN) / Montageschritte(DE)

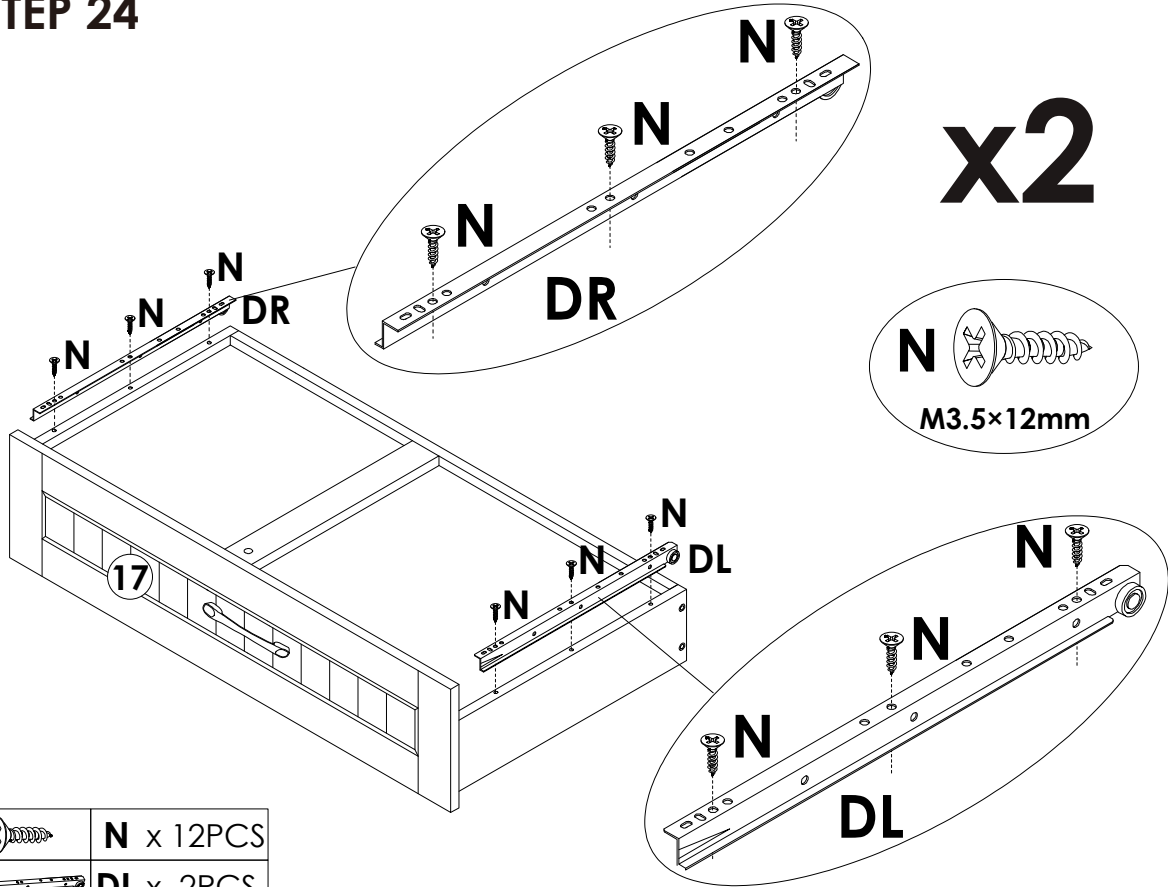



## STEP 24

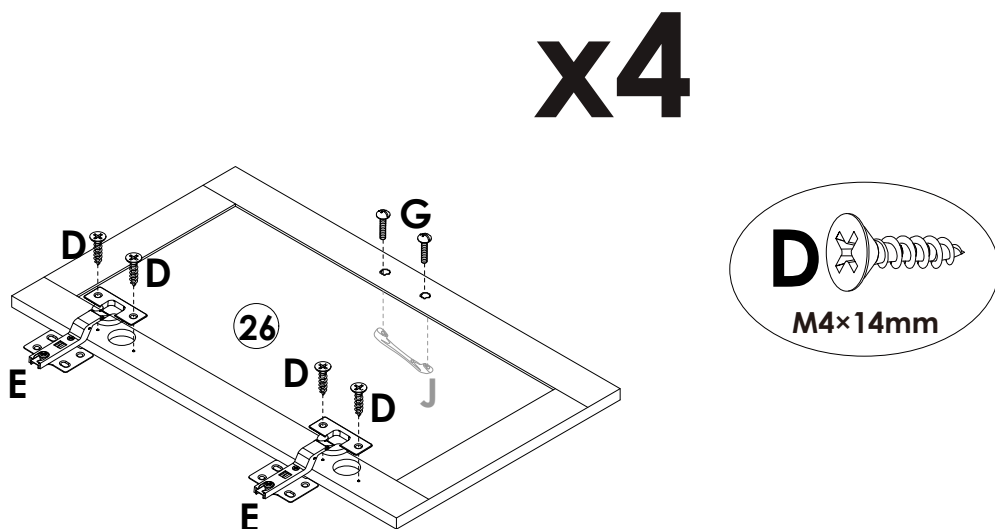

	<b>N</b> x 12PCS
	<b>DL</b> x 2PCS
	<b>DR</b> x 2PCS

## STEP 25



	<b>D</b> x 16PCS
	<b>E</b> x 8PCS
	<b>G</b> x 8PCS
	<b>J</b> x 4PCS

# Assembly Steps(EN) / Montageschritte(DE)

## STEP 26

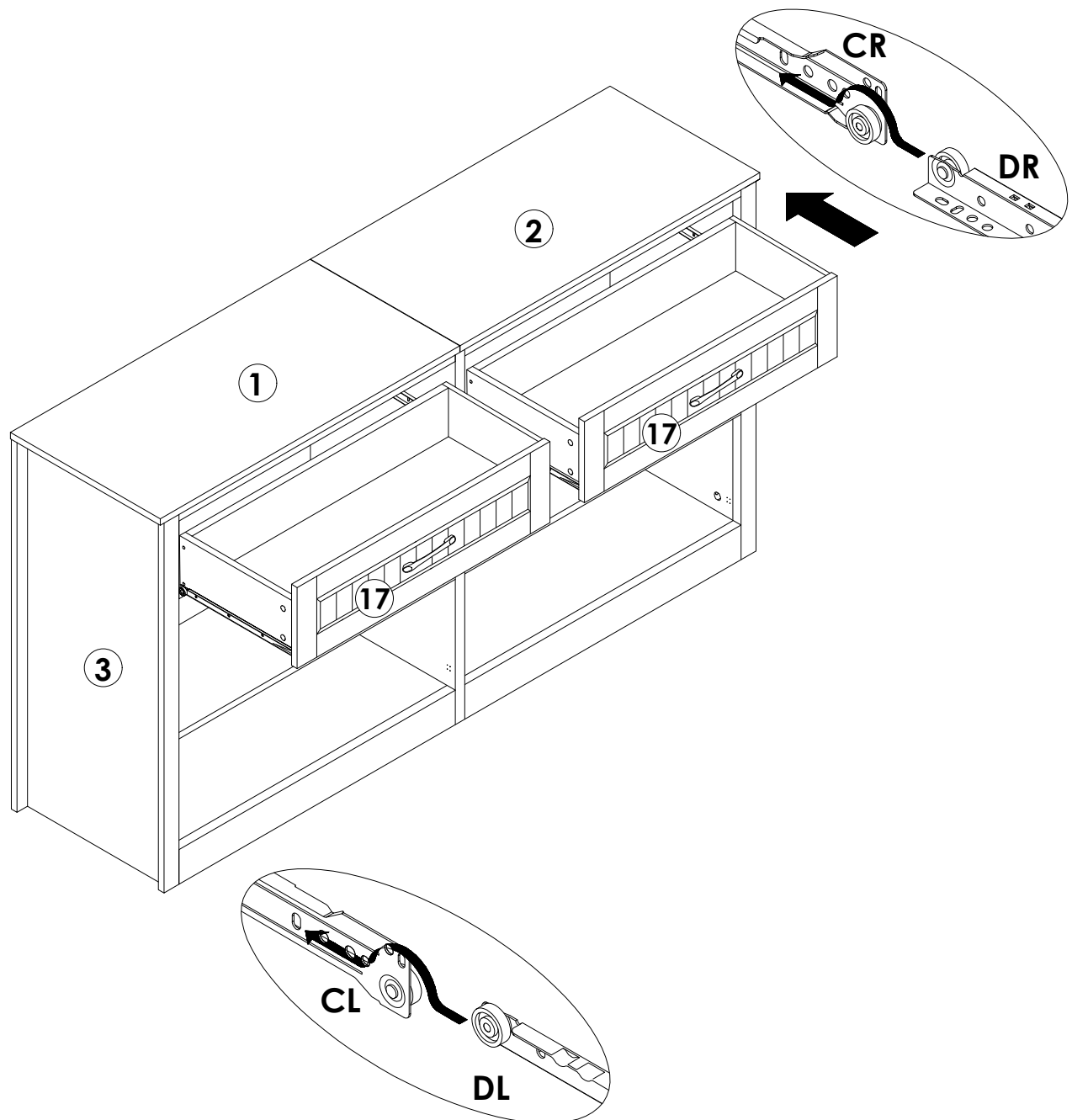



## The ways to adjust the door

- Before adjusting the hinge, please check whether the cabinet is skewed.
- If the skew can not be repaired, please remove the anti-tipping device first, then adjust the cabinet to vertical position.
- Please adjust the hinge with the door open.
- Please operate it with more than 2 people, one person holds the door and the other one adjusts the screw.

### Components Name

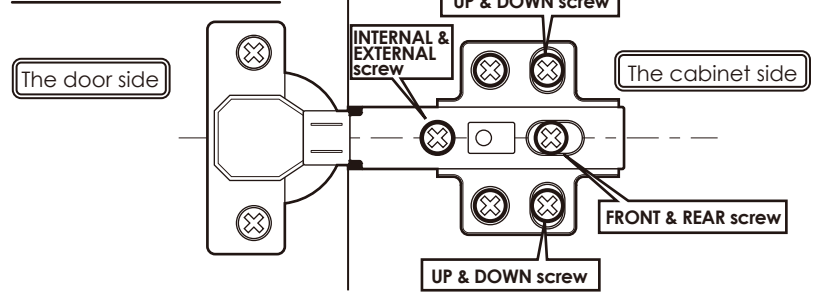

### Obvious gaps between doors or Doors don't look closed

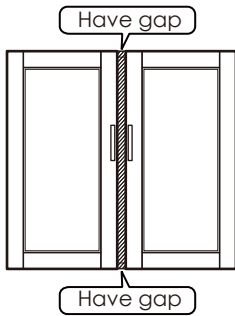

- 1 Turn "internal & external screw" to the right can make the door approach inside. Please adjust the doors little by little.

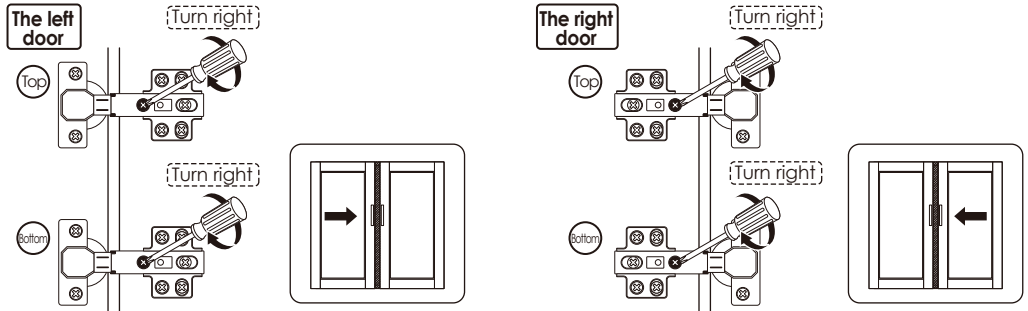

※ If the 2 doors are overlap, please turn the "internal & external screw" to the left.

### When door is crooked



Please take the following steps to adjust first.

- 1 Rotate the "front and rear screws" to the left

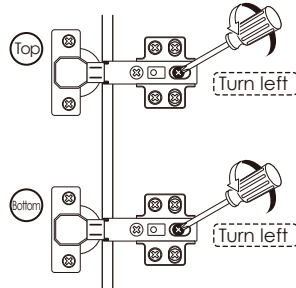

※ After adjusting the "front and rear screw", the door still does not change, please turn the "internal & external screw" to the right slightly.

- 2 Push the door to the cabinet

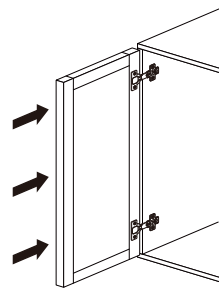

- 3 Rotate the "front and rear screws" to the right

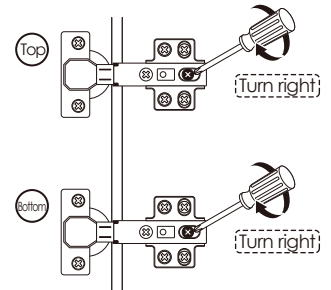

### When door is leaning

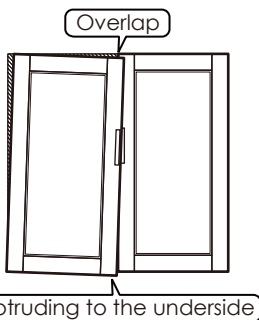

- 1 Turn "internal & external screw" to the left can make the top of the door tilted outward.

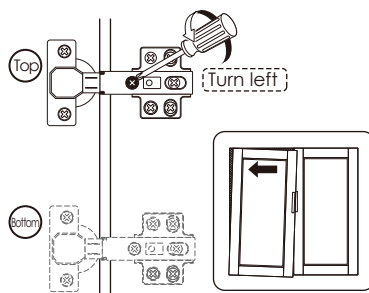

### Protruding to the upside

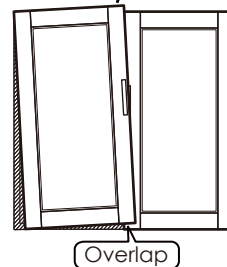

- 1 Turn "internal & external screw" to the left can make the bottom of the door tilted outward.

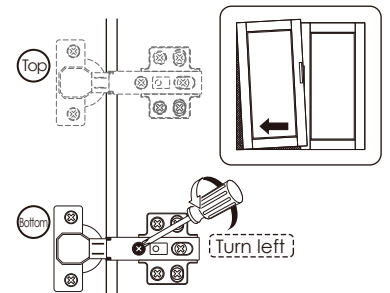

### When the door is higher on top

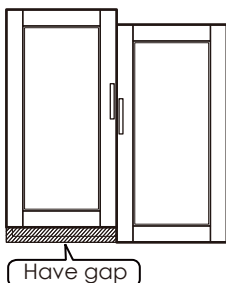

- 1 Turn "up & down screw" to the left

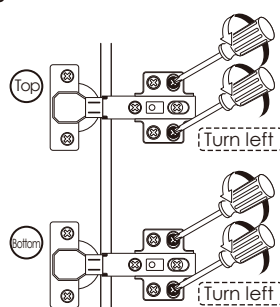

- 2 Lower the door's height so that 2 doors are of the same height.

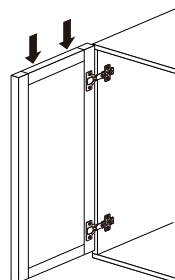

- 3 Turn "up & down screw" to the right

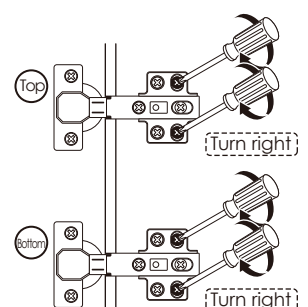

※ If the door is lower on bottom, please lift up the left door slightly on step 2



## WARNING



Children have died from furniture tipover. To reduce the risk of furniture tipover:

- **ALWAYS** install Anti-tip device provided.
- **NEVER** put a TV on this product.
- **NEVER** allow children to stand, climb or hang on any drawers, doors, or shelves.
- **NEVER** open more than one drawer at a time.
- Place heaviest items in the lowest drawers.



***This is a permanent label.  
Do not remove!***