

Assembly Instructions

Caution : You must read this before you proceed

Bar chair

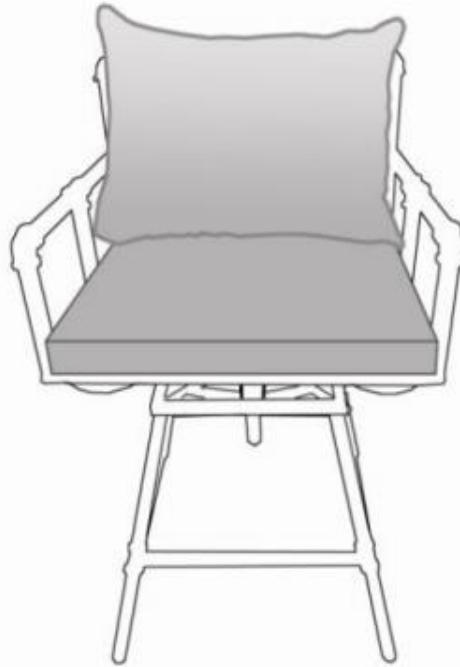

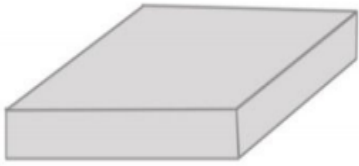

Parts List

Label	Picture	Description	QTY
A	A line drawing of the chair seat, showing a square frame with a grid pattern on the top surface.	Chair Seat	1
B	A line drawing of the chair base, showing a four-legged frame with a central support structure.	Chair Base	1
C	A shaded drawing of a square pillow, representing the backrest cushion.	Pillow	1

D		Seat Cushion	1
---	---	--------------	---

Hardware

Label	Picture	Description	QTY
①		Nut(M8)	5
②		Spanner(M8)	2
③		Screw(M8*15)	5

Assembly Preparation

Before Beginning Assembly:

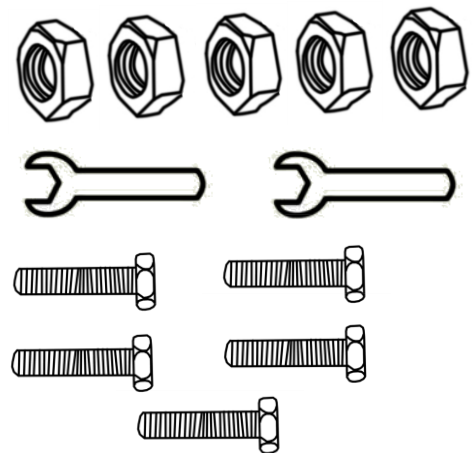
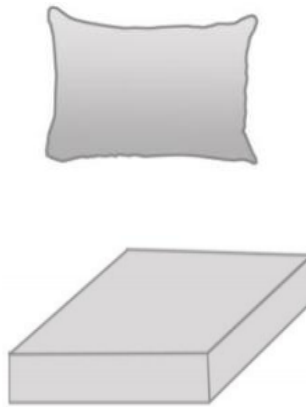
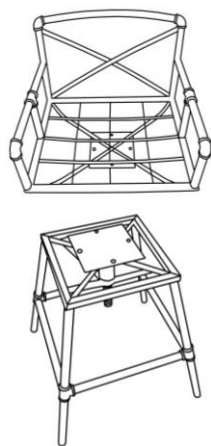

- Read instructions, cover to cover-



- Have 2 adults on hand for assembly-



- Do not assemble on flooring or carpet-



- Assemble on a clean non-marring surface (packing foam)-



- Save all packaging until finished-

Assembly Steps

Overview

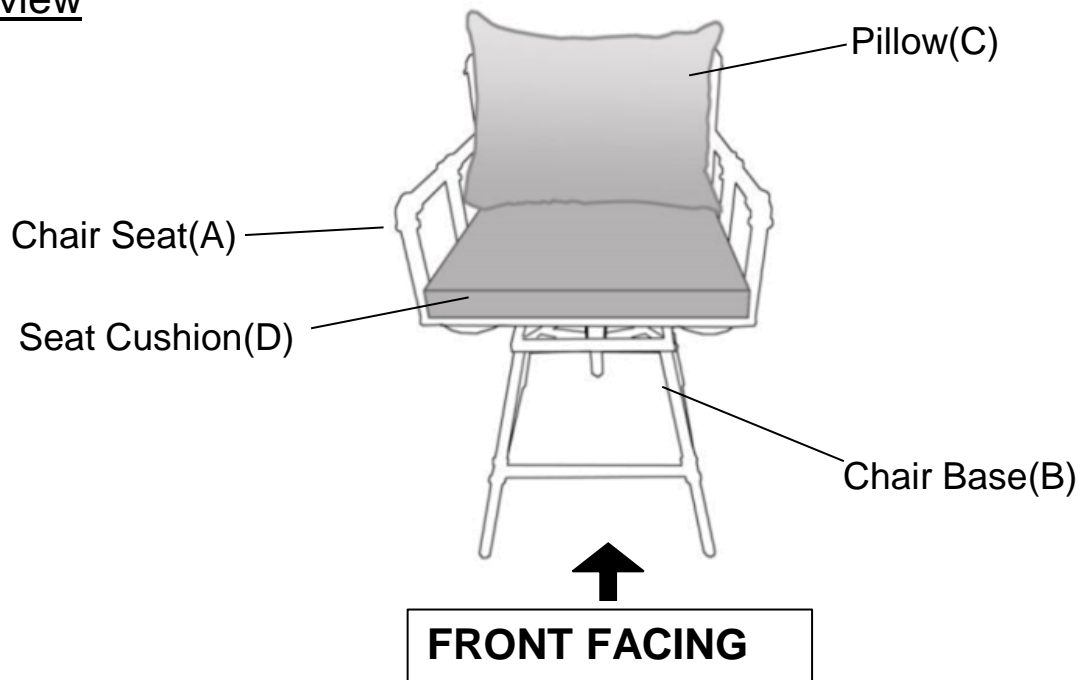

This Table has multiple parts and may require up to some 15 minutes to assemble. To give you an overview of the Coffee Table parts, the above picture is to help you put the various parts into perspective. Please read through the instructions herebelow to familiarise the parts and steps before assembly.

Step 1

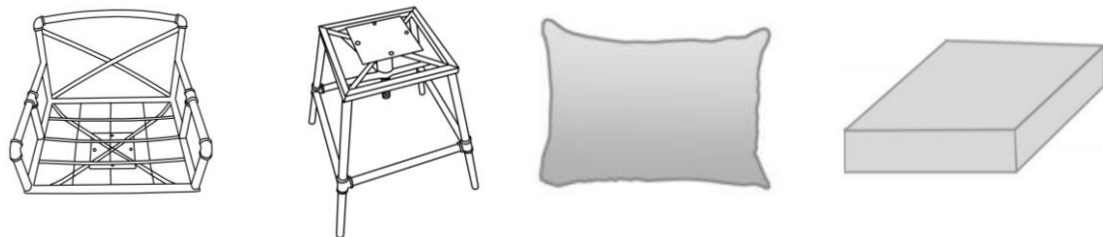

Open the carton and place all the parts onto a clean and soft surface.

Step 2

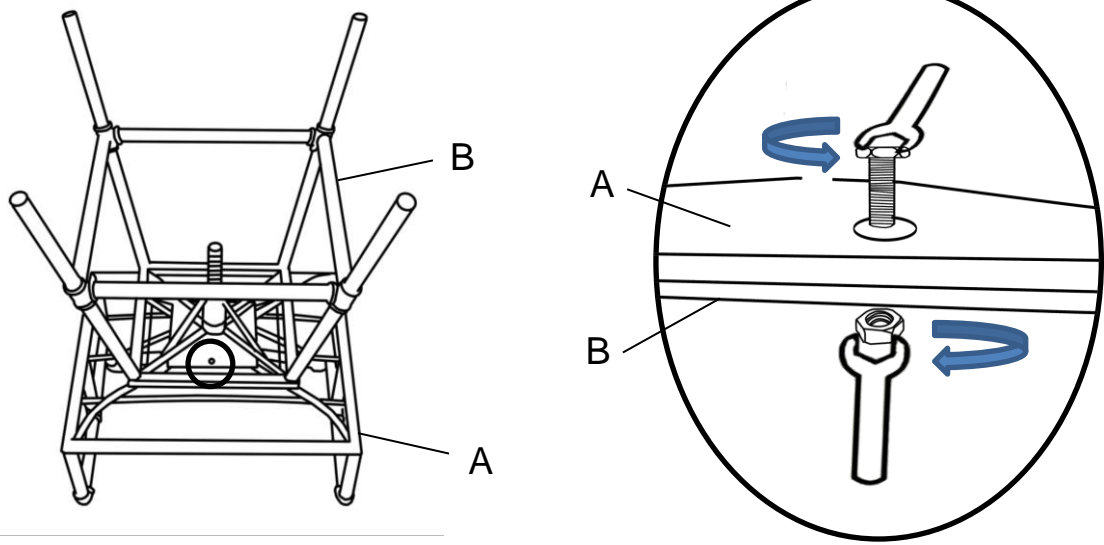

Attach the Chair Seat(A) to Chair Base(B) using Nuts(①) and Screw(③) with Spanner(②).
Fully and securely drive in all Nuts.

Step 2

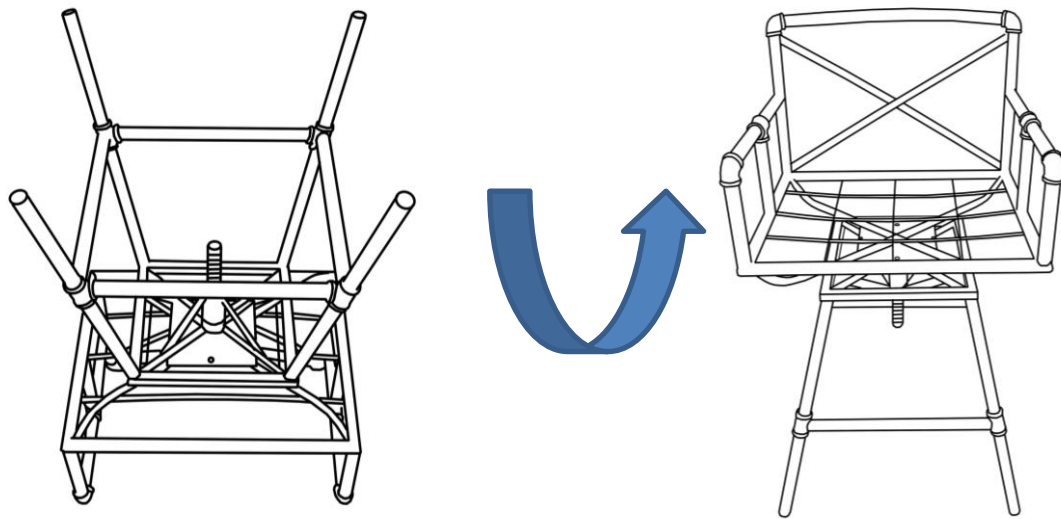





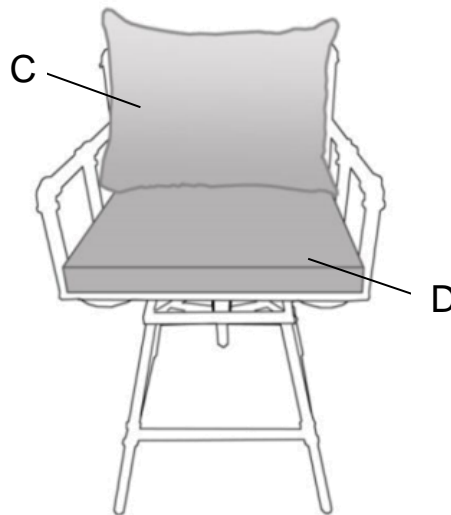











Turn the chair up as above show.



Step3



Place the PILLOW(C) & CUSHION(D) onto seat.
The Barchair is ready for use.

Care & Maintenance

-   ● Do not put hot items directly on furniture surface
-   ● Do not clean furniture with harsh cleansers or polish.
-   ● To obtain the longest lifespan of your outdoor products, minimizing exposure to direct sunlight is recommended.
-   ● Children should not climb or jump on the furniture.
-   ● Do not write on furniture without a padded barrier to protect the surface.
-   ● To obtain the longest lifespan of your outdoor products, avoid extended and lengthy exposure to rain, snow, and direct sunshine. Whenever possible cover the product and /or place under patio or awnings.
-   ● Not for commercial use. For residential use only .
-   ● Stains may be removed with mild soap solution and damp cloth.

-
-   ● Dust and pick-up spills using a clean, non-colored, lint-free cloth .