

ASSEMBLY INSTRUCTIONS

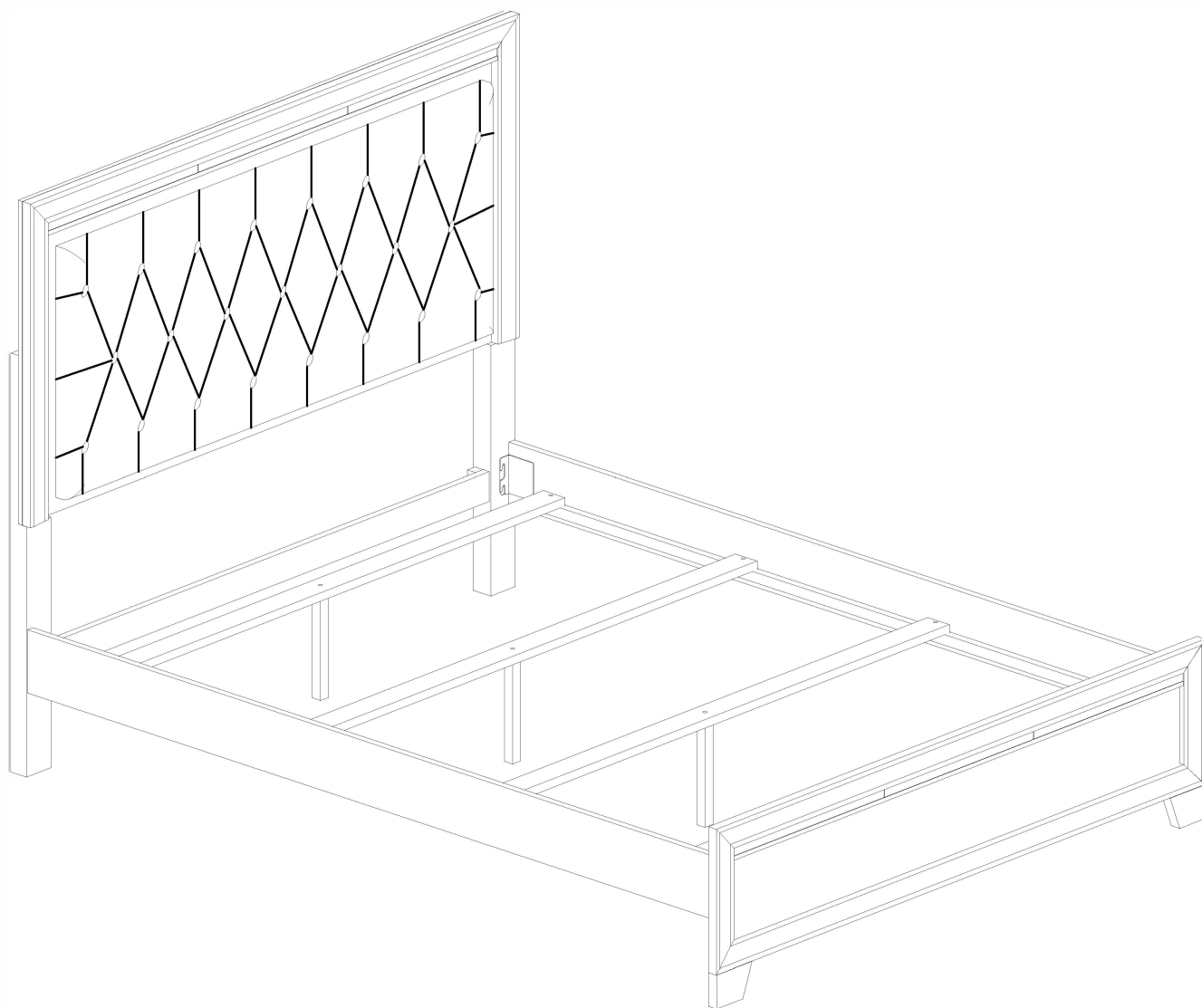

Description : Queen Bed

Dimension : 86.41" x 63.07" x 56.10" H

Queen Bed

BEFORE ASSEMBLY

Thank you for purchasing this quality product. This product has been designed for easy assembly and constructed for durability. Please take the time to read and follow the assembly instructions carefully.





Be sure to check all packing material carefully for small parts which may have come loose inside the carton during shipment. Please separate, identify, and count all parts and metal hardware. Compare with part list to be sure all parts are present.

If hardware is missing or you have difficulty assembling this product, please call for us.

IMPORTANT NOTE:

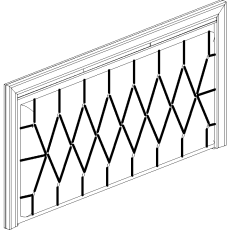
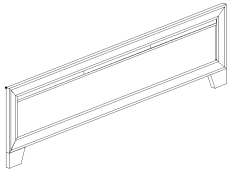
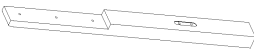
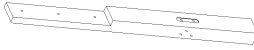

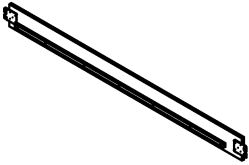
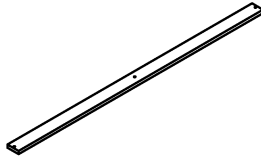





- Place all wooden parts on a clean and smooth surface such as a rug or carpet to avoid the parts from being scratched.
- Remove all wrapping material, including staples & packing straps before you start to assemble.
- DO NOT tighten all screws and bolts until completely assembled.
- Keep all hardware parts out of reach of children.

PART LIST

NO	Description	Q'Ty	Sketch	NO	Description	Q'Ty	Sketch
BOX A : A+B+C+D+E							
A	Headboard panel	1		B	Footboard	1	
C	Left headboard leg	1		D	Right headboard leg	1	
E	Support bar	1					
BOX B : F+G+H							
F	Side rails	2		G	Slats	4	
H	Center support legs	4					

Queen Bed

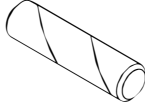
HARDWARE LIST

NO	Description	Q'Ty	Sketch	NO	Description	Q'Ty	Sketch
1	Allen Head bolts 1/4" x 45mm	8		2	Lock Washer Ø1/4"	8	
3	Flat Washer Ø1/4"	8		4	Allen key	1	
5	Allen Head bolts 5/16" x 20mm	8		6	Flat Washer Ø5/16"	8	
7	Lock Washer Ø5/16"	8		8	Wood Dowels Ø8 x 30mm	4	
9	Screws Ø8 x 30mm	8					

STEP 1 : Assemble headboard

Assemble horizontal support bar (E) with legs (C&D) by Bolt (1) , Lock washer (2) , flat washer (3) and dowels (8) .
Do not tighten bolts.

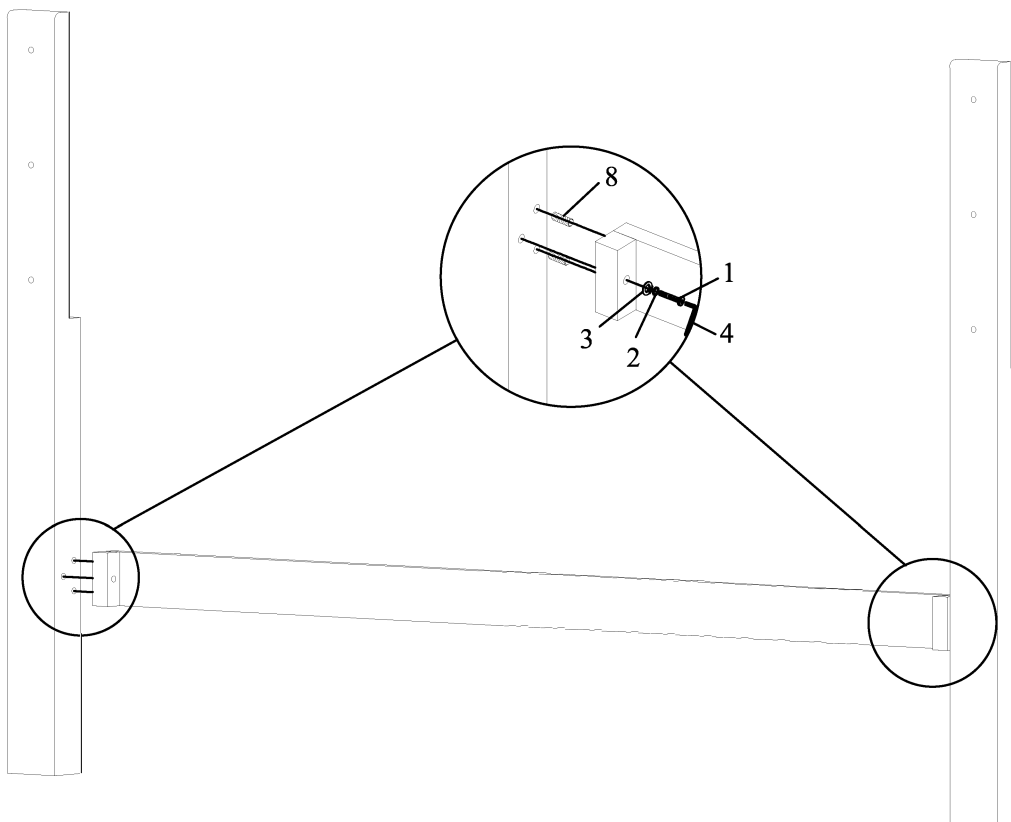

Queen Bed

STEP 2 : Assemble Headboard

Fix leg frame with headboard (A) by Bolt (1) , Lock washer (2) , flat washer (3) . Tighten bolts.

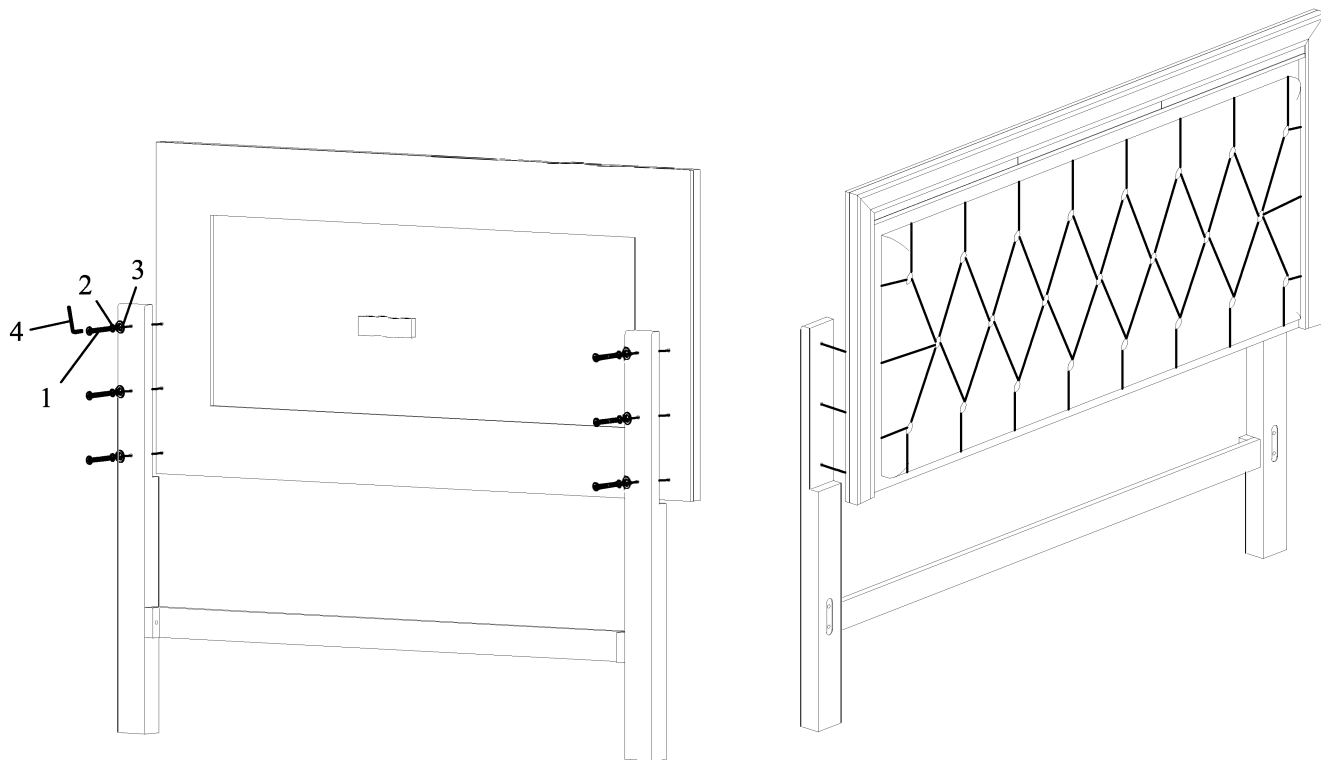

STEP 3 : Assemble side rails

Assemble side rails (F) with headboard frame & footboard (B) by Bolt (5) , Lock washer (7) , flat washer (6) . Tighten bolts.

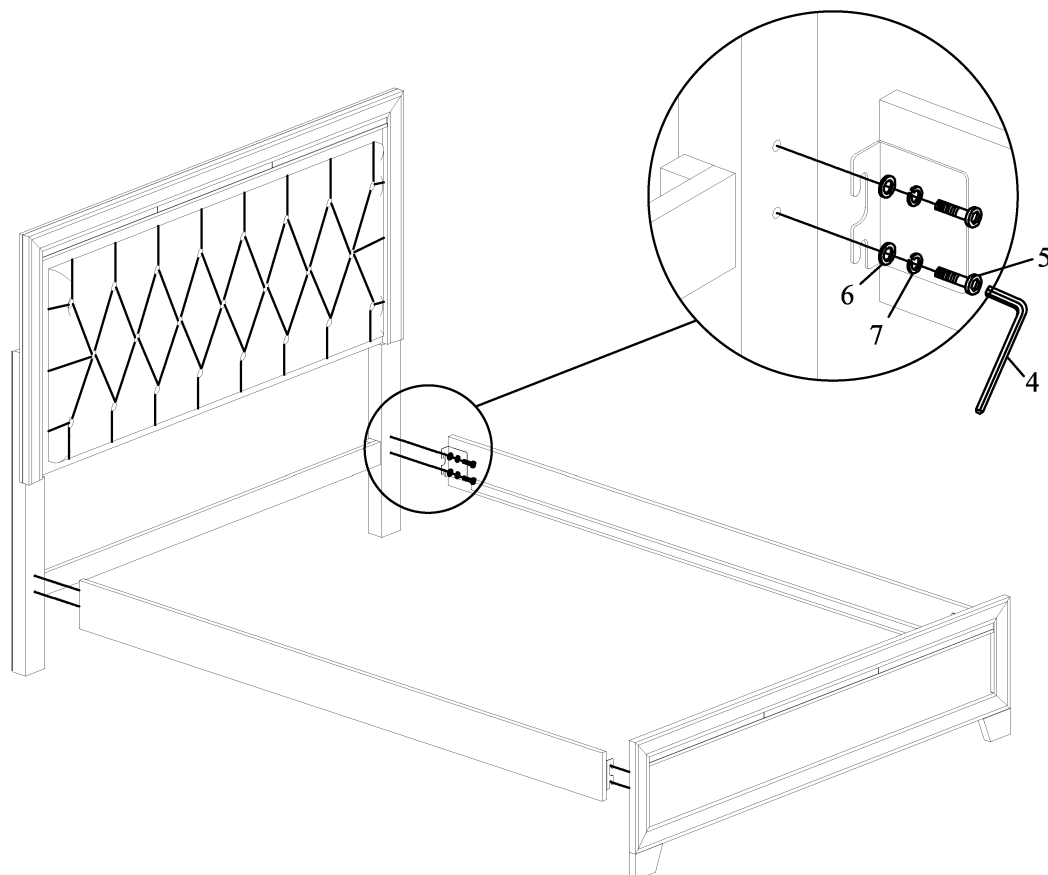

Queen Bed

STEP 4 : Assemble support legs

Assemble the support legs (H) with Slats (G)

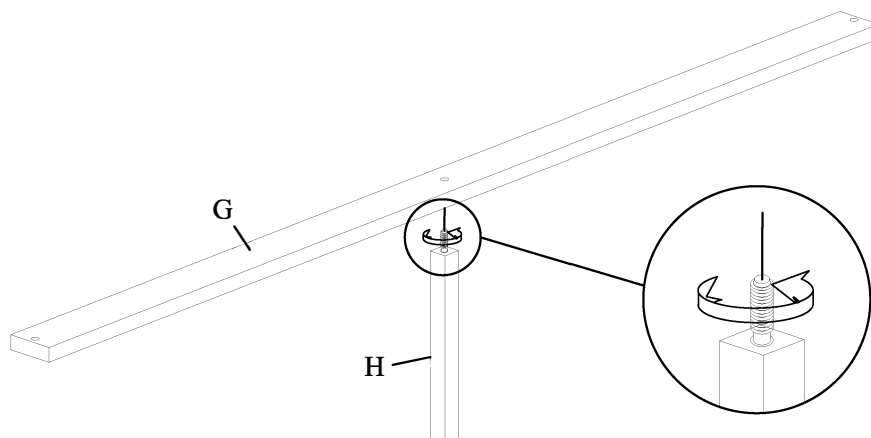

STEP 5 : Attach slats

Attach the slats (G) to side rails with the screws (9) and a screw driver

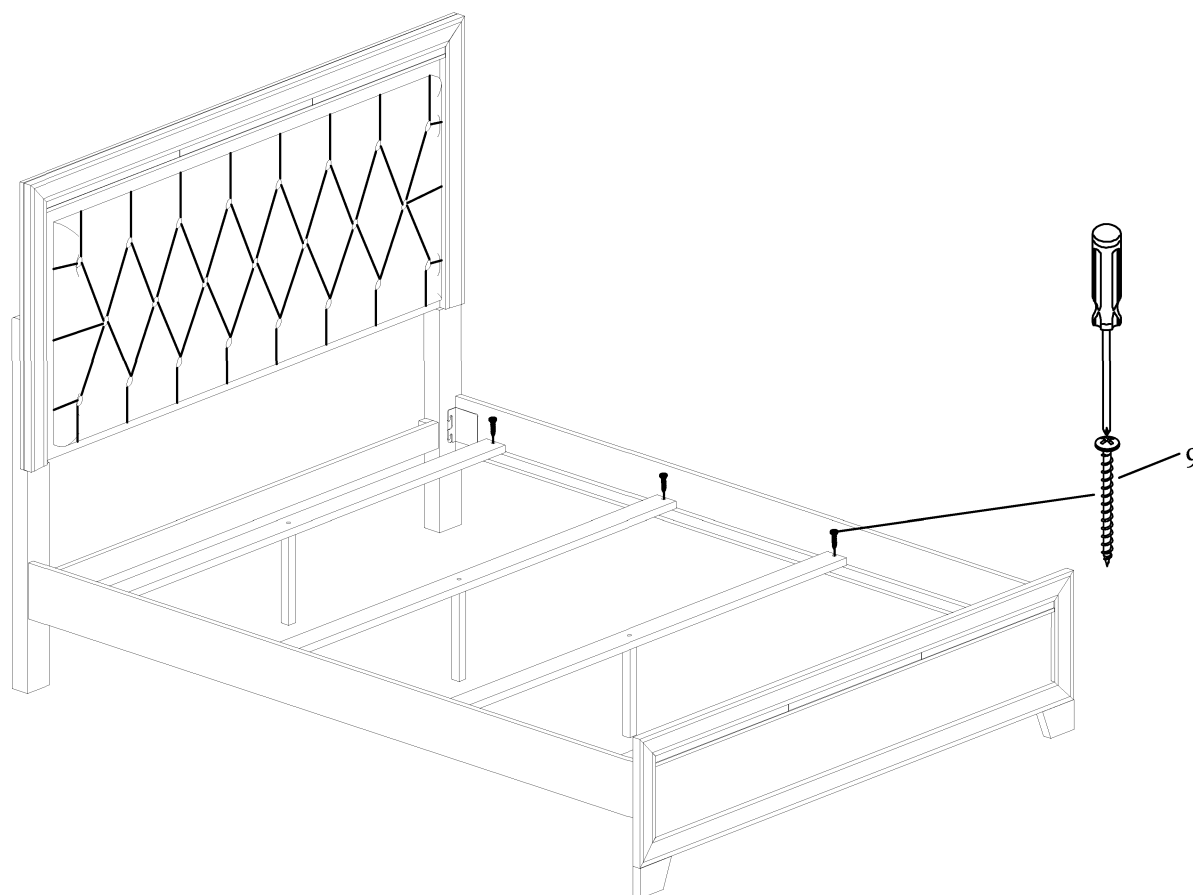

Queen Bed