

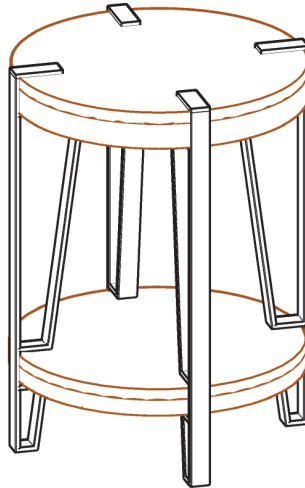



Round End Table





Thank you for purchasing our Round End Table. **It will be helpful to have a second person available during the assembly of this product.**

Assembly Instructions

Lay out all parts on a "non-abrasive" surface to avoid scratching furniture.

NO.	DRAWING	DESCRIPTION	QTY.
A		TOP	1
B		SHELF	1
C		LEG	4

NO.	DRAWING	DESCRIPTION	QTY.
D		M6X25MM BOLT	8
E		ALLEN KEY	1

Step 1

Read through these instructions thoroughly before beginning assembly. We have found this to be of great value when first assembling this product.

Step 2

Remove all parts and hardware from packing material. Wooden pieces should be placed on a non abrasive surface (like the carton or carpet) to prevent damage to the finish.

Step 3

Lay Top (A) upside down and attach 4 Legs (C) using 8 6M x 25mm Bolts (D).

TIGHTEN ALL BOLTS AT THIS TIME.

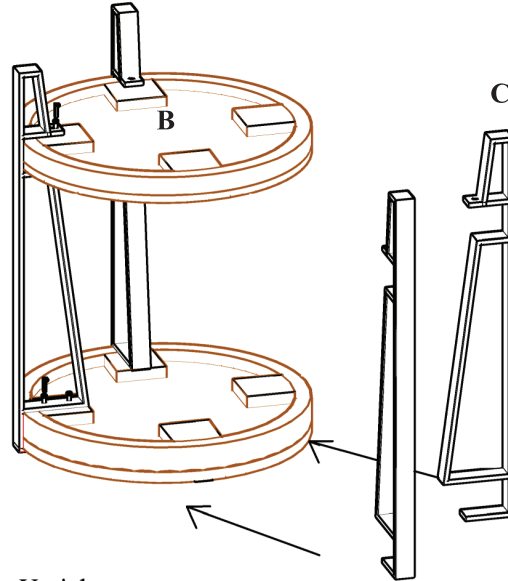

Step 4

Set Round End Table Upright.

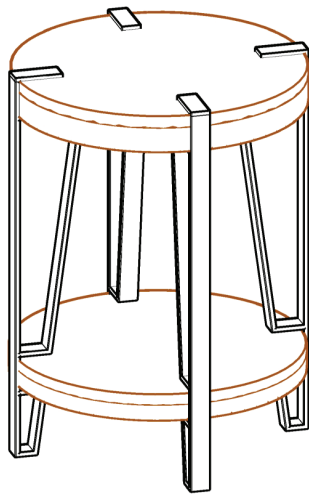

CARE

Clean with mild soap and wipe dry.
