

SNDOAS

INSTALLATION AND USER'S MANUAL

CONTENT

Notice	(4)
Installation	(5)
Notice of installation	(7)
Safety Warning	(8)
USE	(9)
Maintenance	(10)
Abnormity and Solution	(12)

Provide user manual;

Clean the cooker hood according to the instruction manual and keep the unit from danger of burning. There is a fire risk if cleaning is not carried out in accordance with the instructions.

If the supply cord is damaged, it must be replaced by the manufacturer, its service agent or similarly qualified persons in order to avoid a hazard.

The air must not be discharged into a flue that is used for exhausting fumes from appliances burning gas or other fuels

This appliance can be used by children aged from 8 years and above and persons with reduced physical, sensory or mental capabilities or lack of experience and knowledge if they have been given supervision or instruction concerning use of the appliance in a safe way and understand the hazards involved

Children should be supervised to ensure that they do not play with the appliance.

Cleaning and user maintenance shall not be made by children without supervision

Do not flame under the range hood.

CAUTION: Accessible parts may become hot when used with cooking appliance.

The warning shall be in the same part of the instructions that include details of how to mount the equipment.

The instructions shall include detail on how to clean surfaces in contact with food.

Range Hood

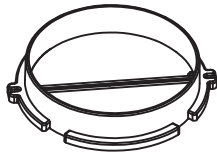
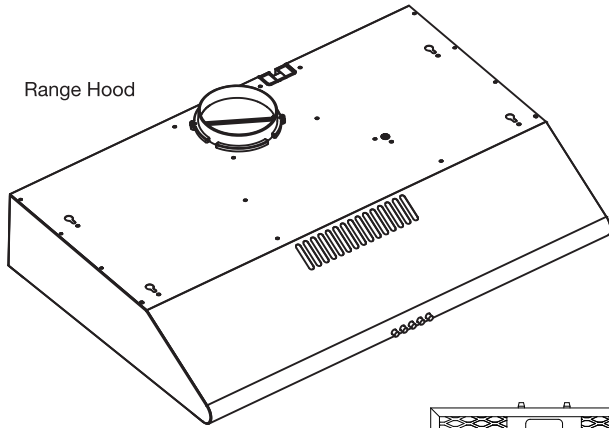

Vent/Damper

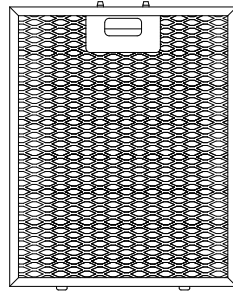

2 Aluminum Filters

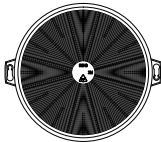

1 Charcoal Filters

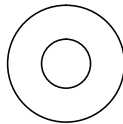

4 Flat Washers

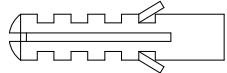

4 Mounting Anchors

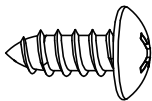

2 Pointed Tail Screws

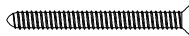

4 Mounting Screws(A)



4 Mounting Screws(B)



Hardware Note: For safety reasons, range hood mounting screws and anchors will not be included due to the variation of cabinetry constructions and wall material. Please consult your installation specialist regarding the optimal type of mounting screws and wall anchors to suit your home's construction.

(1) NOTICE

1. Thank you for choosing our cooker hood. Please read the instruction manual carefully before use.
2. The installation work must be undertaken by a qualified and competent fitter.
3. The manufacturer disclaims all liability for any damage or injury caused as a result of not following instructions for installation contained in the following text.

The cooker hood is used on 110-120V/60Hz

(2). Installation

Installation Way one:

1. Place at a distance of 65-75cm from the cooking surface, drill 4 holes of $\Phi 8$ mm and depth of 40mm.
2. Insert 4 swelling rubber plug into 4 holes.
3. Fix air outlet into the vent on top of the hood.
4. Open filters, keep the hood in line and tighten the screws.
5. Fix filters.

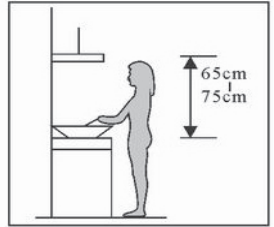

Pic1

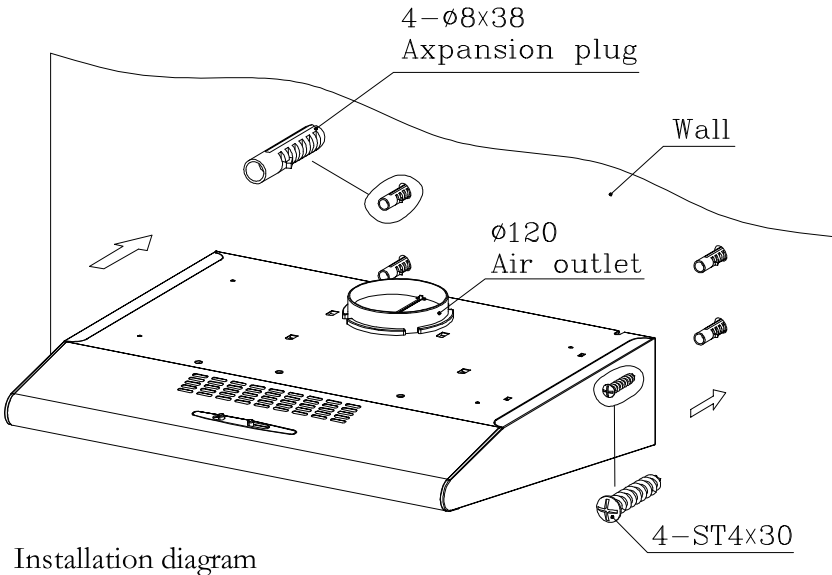
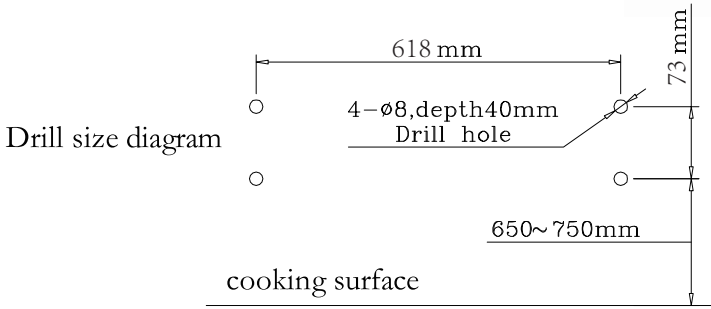

Installation diagram

Installation Way two:

1. Drill 4 holes of $\Phi 5\text{mm}$ and $\Phi 130\text{mm}$ at the bottom of the hanging cupboard.
2. Fix air outlet into the vent on top of the hood.
3. Open filters, keep the hood in line, insert screws and swelling rubber plug, tighten the screws.
4. Fix filters.

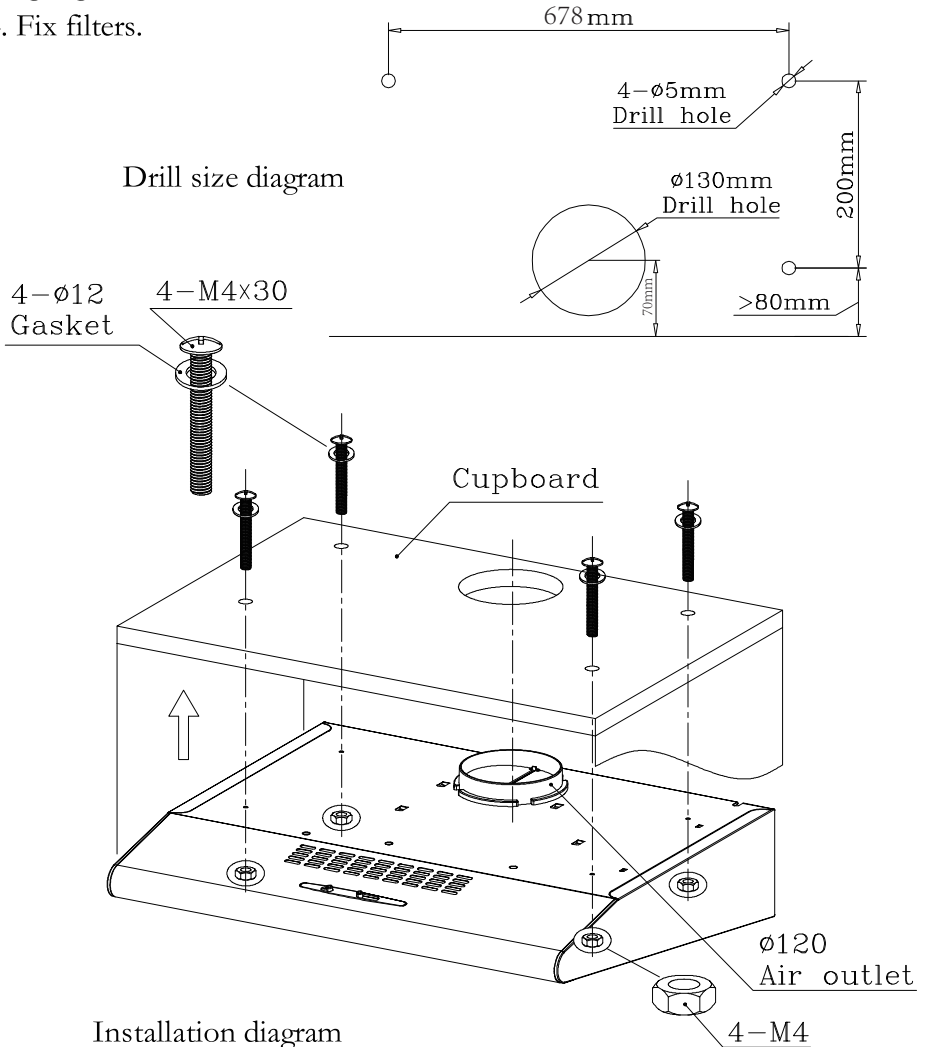

---Warning:Failure to install the screws or fixingdevice in accordance with these instructions mayresultin electrical hazards.

(3) NOTICE OF INSTALLATION

1. Before installation, please ensure the area is clean to avoid suction of the remaining bits of broken wood and dust.
2. It cannot share the same air ventilation tube with other appliance such as gas tube, warmer tube, and hot wind tube.
3. The bending of ventilation tube should be $\geq 120^\circ$, parallel or above the start point and should be connected to the external wall.
4. After installation, make sure that the extractor is level to avoid grease collection at one end.

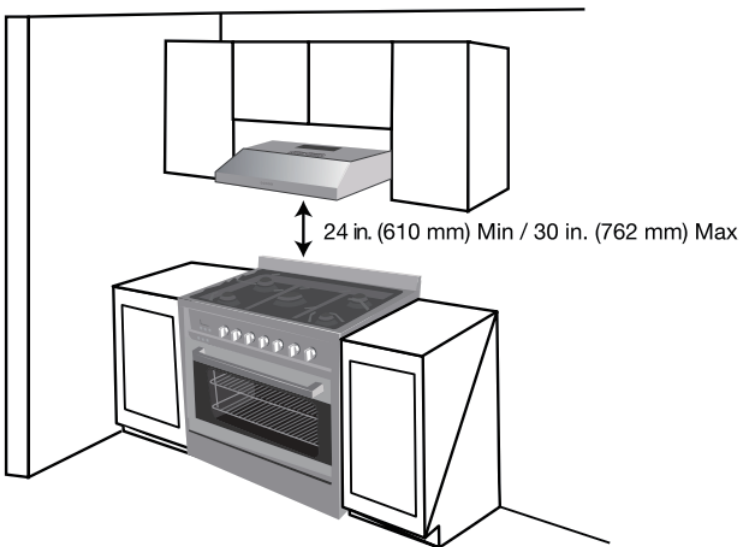

(4)SAFETY WARNING

- Never let the children operate the machine.
- The cooker hood is for home use only, not suitable for barbecue, roast shop and other commercial purpose.
- The cooker hood and its filter should be clean regularly in order to keep in good working condition.
- Clean the cooker hood according to the instruction manual and keep the unit from danger of burning.
- Forbid the direct baking from the gas cooker.
- Please keep the kitchen room a good convection.
- Before connecting this appliance check that the power supply cord is not damaged. A damage supply cord must be replaced by qualified service personnel only.
- There shall be adequate ventilation of the room when the range hood is used at the same time as appliances burning gas or other fuels
- The air must not be discharged into a flue that is used for exhausting fumes from appliances burning gas or other fuels
- Regulations concerning the discharge of air have to be fulfilled.
- This appliance if not intended for use by persons(including children) with reduced physical, sensory or mental capabilities, or lack of experience and knowledge, unless they have been given supervision or instruction concerning use of the appliance by a person slide for their safety.
- Children should be supervised to ensure that they do not play with the appliance.
- Do not flambé under the range hood.
- The range hood is not intended to be installed over a hob having more than four hob elements
- This appliance is not intended for use by persons (including children) with reduced physical, sensory or mental capabilities, or lack of experience and knowledge, unless they have been given supervision or instruction concerning use of the appliance by a person responsible for their safety.
- Children should be supervised to ensure that they do not play with the appliance.
- The air must not be discharged into a flue that is used for exhausting fumes from appliances burning gas or other fuels.
- When the range hood and appliances supplied with energy other than electricity are simultaneously in operation, the negative pressure in the room must not exceed 4 Pa (4 x 10⁻⁵ bar).
- CAUTION: Accessible parts may become hot when used with cooking appliances.

Electrical Shock Hazard





- Only plug this unit into a properly earthed outlet. If in doubt seek advice from a suitably qualified engineer.
- Failure to follow these instructions can result in death, fire, or electrical shock.

(5)How to use your range hood

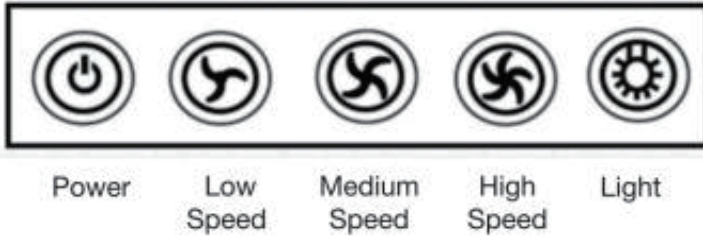
This range hood can vent the air of the kitchen to remove the odor and keep an optimum level of air quality inside the room. it also allows you to illuminate the cooking area.

Control panel:



- Press button  , the range hood will run at low speed.
- Press button  , the range hood will run at medium speed.
- Press button  , the range hood will run at high speed.
- Press button  , to turn on/off the light.
- Press button  , to turn on/off the range hood.

To achieve the best oil fume removal effect, it is recommended that you continue to keep it on for 15 minutes after cooking.

(6) MAINTENANCE

6.1 The cleaning of the carbon grease filter mesh

The filter mesh is made of high-density stainless steel. Please do not use the corrosive detergent on it. Keeping this filter clean will keep the appliance running correctly. Please strictly follow the guidelines below.

Method 1: Put the mesh into 40-50 c clean water, pour on detergent, and soak for 2-3 mins. Wear gloves and clean with a soft brush. Please do not apply too much pressure, as the mesh is delicate and will damage easy.

Method 2: If instructed to do so, it can be put into a dishwasher, set the temperature at around 60 degrees.

Install Filters

To install filters, follow these six steps

- Angle the filter into slots at the back of the hood.
- Push the button on handle of the filter.
- Release the handle once the filter fits into a resting position.
- Repeat to install all filters.

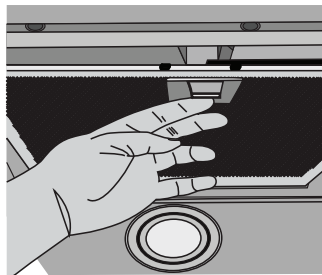

Charcoal aluminum filter

Figure #10

Note: Increase the charcoal aluminum filter cleaning/replacement frequency if the hood is used for more than 2 hours a day. Always use genuine filters from the manufacturer.

6.2 Carbon filter life time: Suggest changing to new one every 3 months (According to different kitchen condition, the life time of carbon filter might be longer or shorter than 3 months).

Fix carbon filter into the unit and turn it in clockwise direction. Repeat the same on the other side.

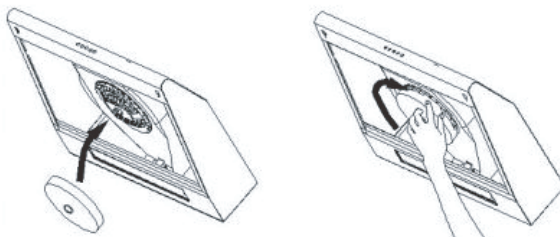

Important Notice:

- 1. Make sure the filter is securely locked. Otherwise, it would loosen and cause abnormal noise and danger.**
- 2. Using carbon filter would reduce the air flow of the range hood.**

6.3 Notice of cleaning cooker hood

- A.** To protect the main body from corrosion over a long period of time, the cooker hood should be cleaned with hot water plus non corrosive detergent every two months.
- B.** Please do not use abrasive detergent for it will damage the body.
- C.** Keep the motor and other spare parts free from water, as this will cause damage to the appliance.
- D.** Before cleaning the appliance please remember to cut off power
- E.** The carbon filter shouldn't be exposed to heat.
- F.** Please don't tear open the fixed bar around the carbon filter
- G.** If the plug or cord is damaged, please replace it with special soft cord.

(7) Abnormity and Solution

Fault	Cause	Solution
Light on, but motor does not work	The leaf blocked	Get rid of the blocking
	The capacitor damaged	Replace capacitor
	The motor jammed bearing damaged	Replace motor
	The internal with of motor off or a bad smell from the motor	Replace motor
Light does not work, motor does not work	Beside the above mentioned, check the following:	
	Light damaged	Replace lights
	Power cord looses	Connect the wires as per the electric diagram
Oil leakage	One way valve and the air ventilation entrance are not tightly sealed	Take down the one way valve and seal with glue
	Leakage from the connection of U-shaped section and cover	Take U-shaped section down and seal with soap or paint
Shake of the body	The leaf damaged and causes shaking	Replace the leaf
	The motor is not tightly hanged	Lock the motor tightly
	The body is not tightly hanged	Fixed the body tightly
Insufficient suction	The distance between the body and the gas top too long	Readjust the distance
	Too much ventilation from open doors or windows	Choose a new place and resemble the machine
The machine inclines	The fixing screw not tight enough	Tighten the hanging screw and make it horizontal
	The hanging screw not tight enough	Tighten the hanging screw and make it horizontal

SNDOAS

GLOBAL ELECTRICAL HK TRADING LIMITED
ROOMS 1318-19 HOLLYWOOD PLAZA 610 NATHAN ROAD MONGKOK KL
Hong Kong 999077 HK