

# ASSEMBLY INSTRUCTIONS

## 42"x36"x36" COUNTER HEIGHT DINING TABLE

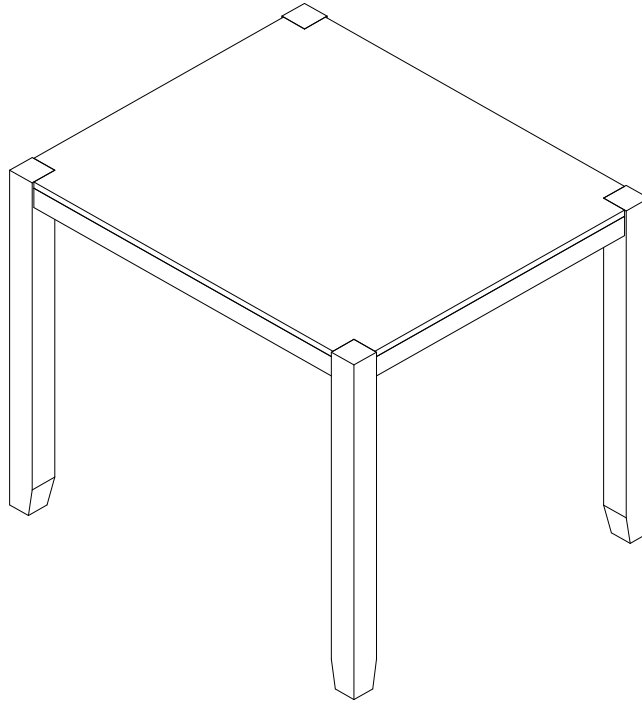

### REPLACEMENT PARTS

Please do not contact the company purchased from as we can help you faster.

Order replacement parts and hardware

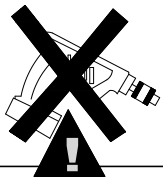

- . Use of power tool to assemble this product will invalidate any claim and damage this product making it unsafe!!!
- . Please assemble on a clean soft surface to avoid damage.

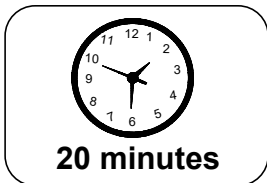
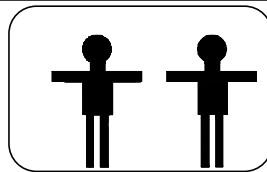

### Tool Included

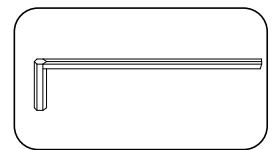

# Part List-42"X36"X36"Counter Height Dining Table

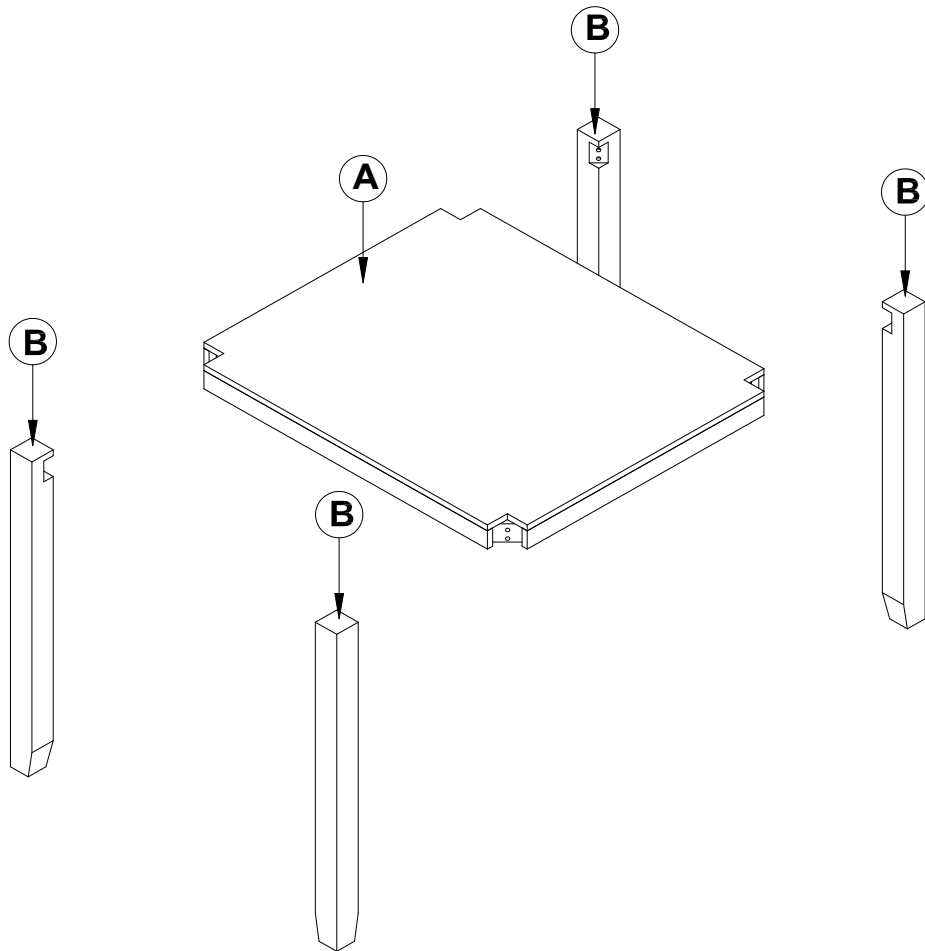

**Identifying the hardware**-Identify the hardware using the illustrations below.

---

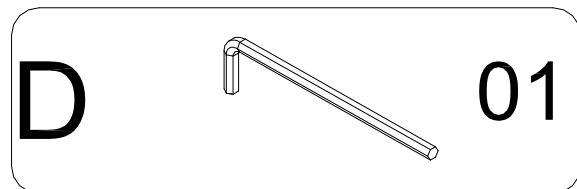

# STEP 1

