

ASSEMBLY INSTRUCTIONS

ASSEMBLY TIPS:

1. Remove hardware from box and sort by size.
2. Please check to see that all hardware and parts are present prior to start of assembly.
3. Please follow attached instructions in the same sequence as numbered to assure fast & easy assembly.



WARNING!



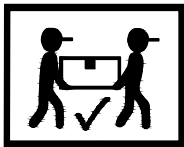





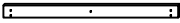
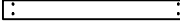
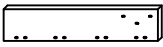

1. Don't attempt to repair or modify parts that are broken or defective. Please contact the store immediately.
2. This product is for home use only and not intended for commercial establishments.

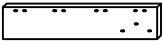

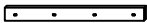
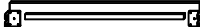
ASSEMBLY TIME

30 MINUTES

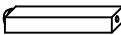
PARTS IDENTIFICATION

A	HEADBOARD PANEL		4 PCS	H	LOWER FOOTBOARD PANEL (WITH "H" LABEL)		1 PC
B	LEFT HEADBOARD SUPPORT (WITH "L" LABEL)		1 PC	I	LEFT FOOTBOARD SUPPORT (WITH "L" LABEL)		1 PC
C	RIGHT HEADBOARD SUPPORT (WITH "R" LABEL)		1 PC	J	RIGHT FOOTBOARD SUPPORT (WITH "R" LABEL)		1 PC
D	CENTRE HEADBOARD SUPPORT		1 PC	K	BED RAIL		2 PCS
E	LEFT HEADBOARD LEG (WITH "L" LABEL)		1 PC	L	BED SLAT		4 PCS
F	RIGHT HEADBOARD LEG (WITH "R" LABEL)		1 PC	M	BED SLAT SUPPORT WITH LEVELER		8 PCS
G	UPPER FOOTBOARD PANEL (WITH "G" LABEL)		1 PC				

ASSEMBLY INSTRUCTIONS

ASSEMBLY TIPS:













1. Remove hardware from box and sort by size.
2. Please check to see that all hardware and parts are present prior to start of assembly.
3. Please follow attached instructions in the same sequence as numbered to assure fast & easy assembly.



WARNING!

1. Don't attempt to repair or modify parts that are broken or defective. Please contact the store immediately.
2. This product is for home use only and not intended for commercial establishments.

HARDWARE IDENTIFICATION

1	BOLT 1 (M8 x 20mm - RBW)		8 PCS	7	FLAT WASHER (5/16" x 22ø - RBW)		30 PCS
2	BOLT 2 (M8 x 25mm - RBW)		8 PCS	8	PAN HEAD SCREW (M4 x 16MM - BLK)		4 PCS
3	BOLT 3 (M8 x 35mm - RBW)		22 PCS	9	FLAT HEAD SCREW (M4 x 32MM - RBW)		8 PCS
4	BOLT 4 (M6 x 25mm - RBW)		4 PCS	10	METAL BRACKET (1 x 18 x 20mm - BLK)		2 PCS
5	BOLT 5 (M6 x 35mm - RBW)		8 PCS	11	SMALL ALLEN WRENCH (M4 x 65MM - BLK)		1 PC
6	LOCK WASHER (5/16" x 14ø - RBW)		30 PCS	12	BIG ALLEN WRENCH (M5 x 65MM - BLK)		1 PC

NOTE:

Phillips head screw driver is required in the assembly process; however, manufacturer does not provided this item.

ASSEMBLY INSTRUCTIONS

STEP 1

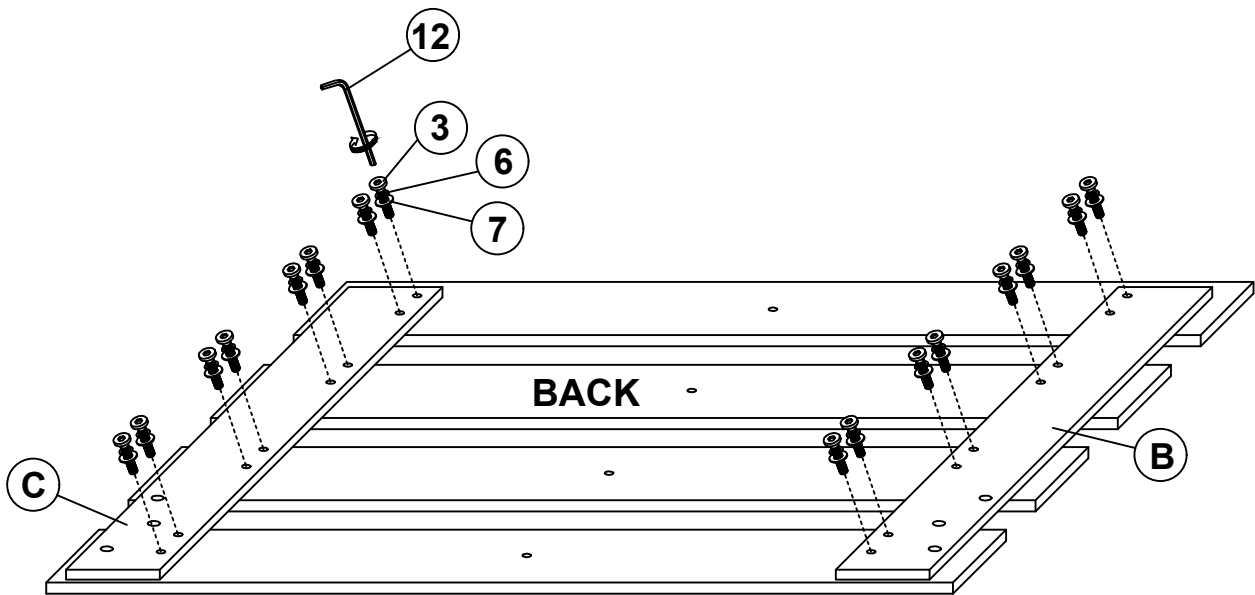

STEP 2

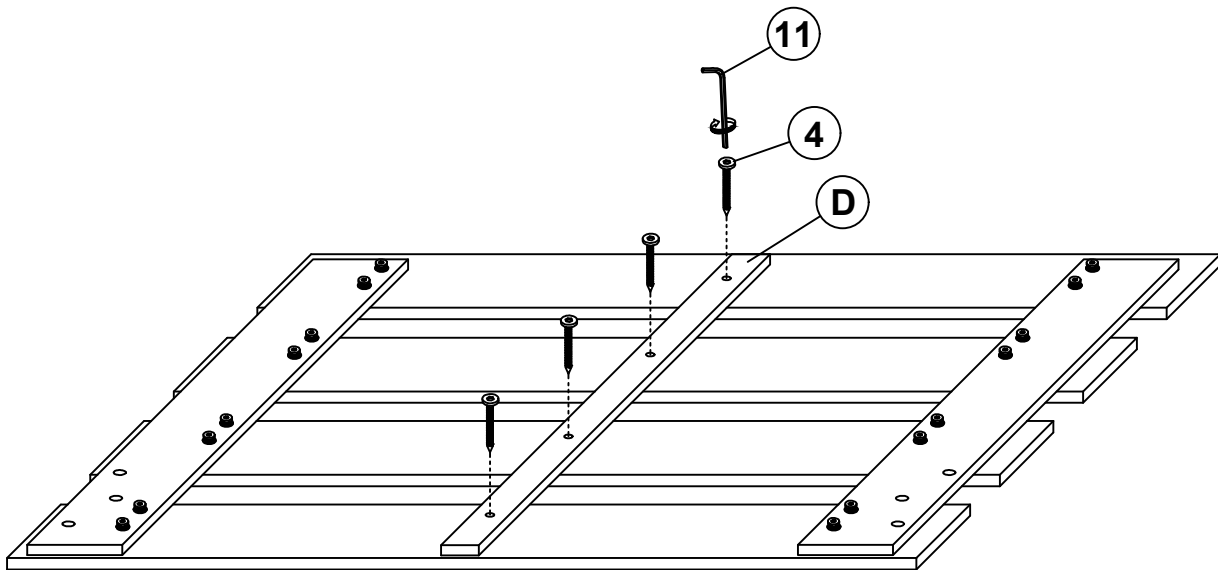

ASSEMBLY INSTRUCTIONS

STEP 3

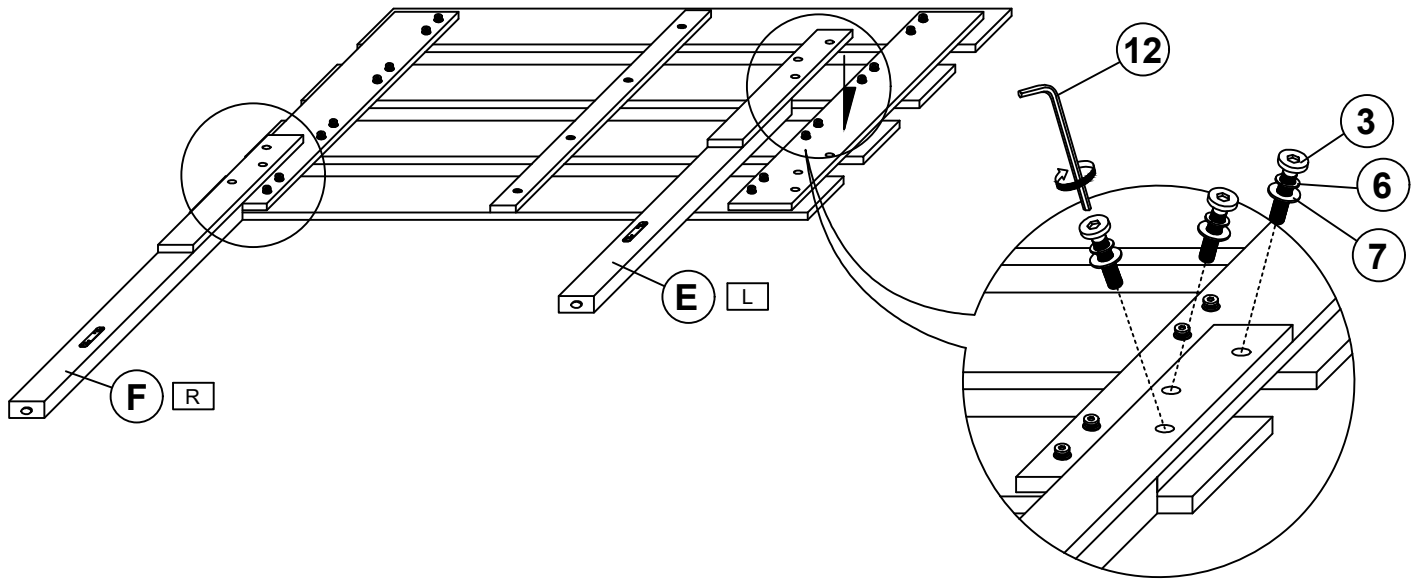

STEP 4

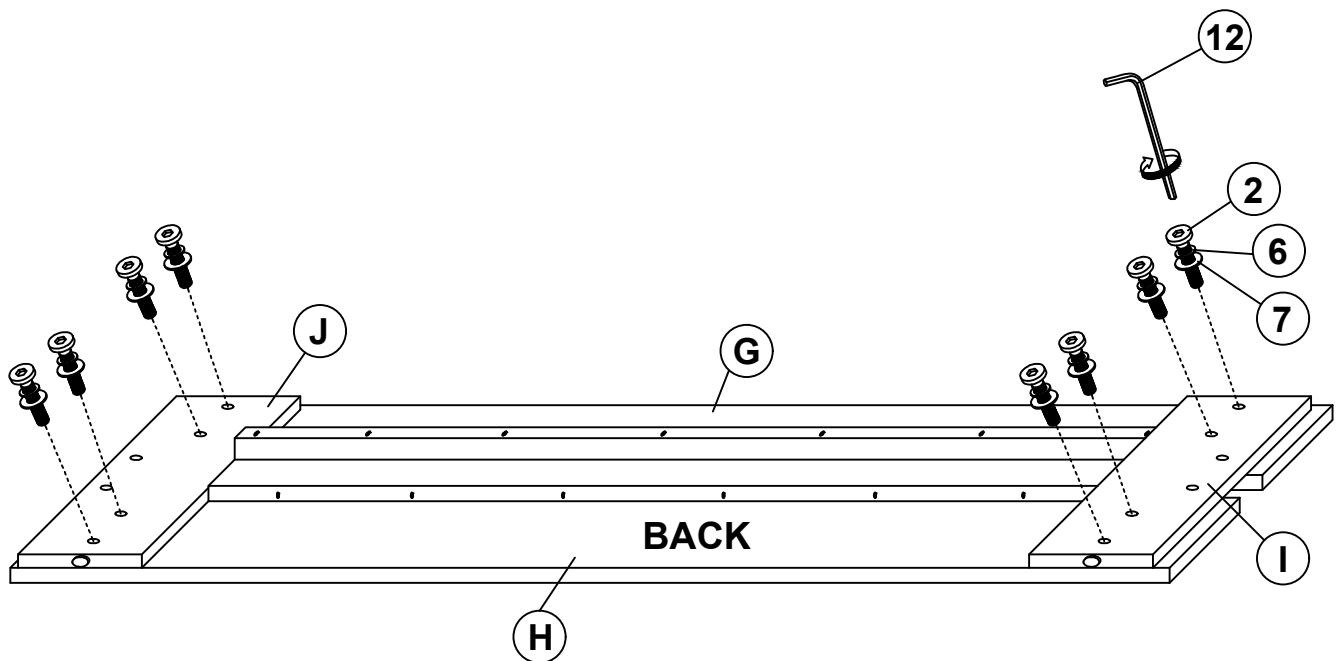

ASSEMBLY INSTRUCTIONS

STEP 5

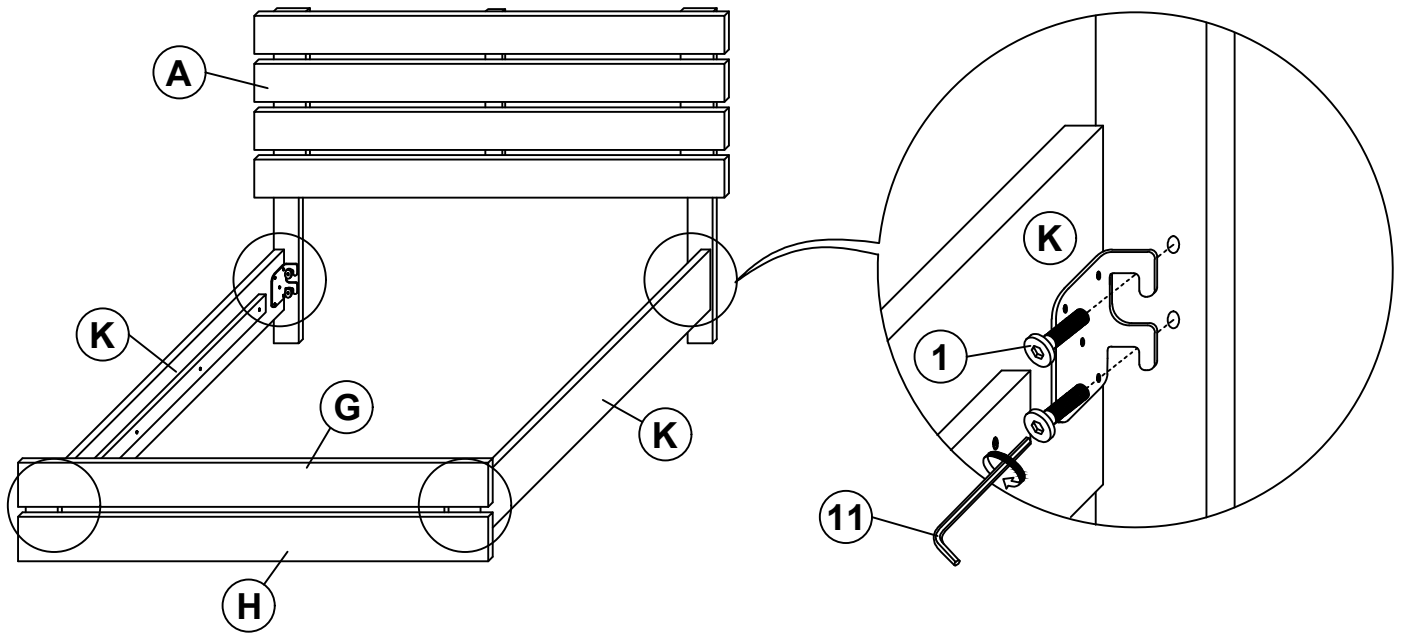

STEP 6

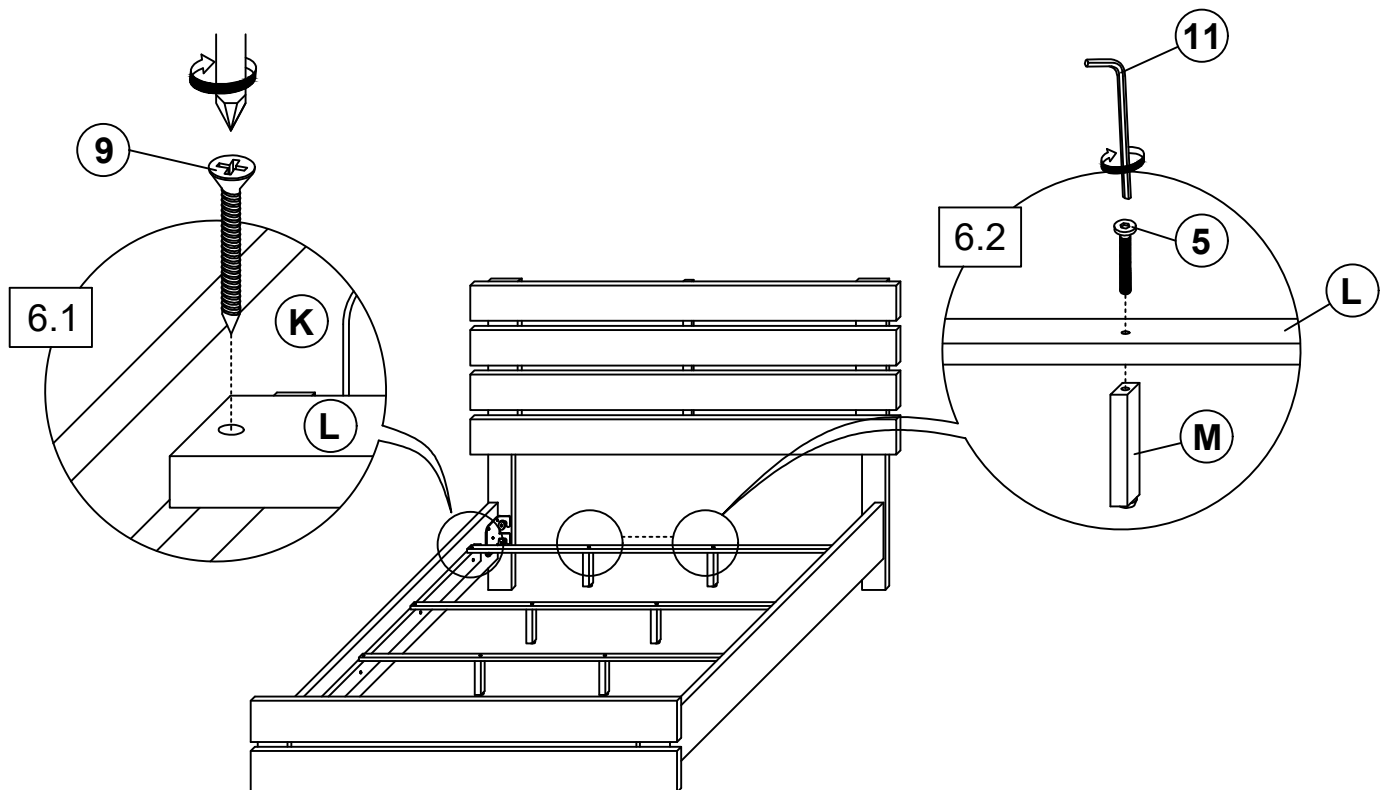

ASSEMBLY INSTRUCTIONS

STEP 7

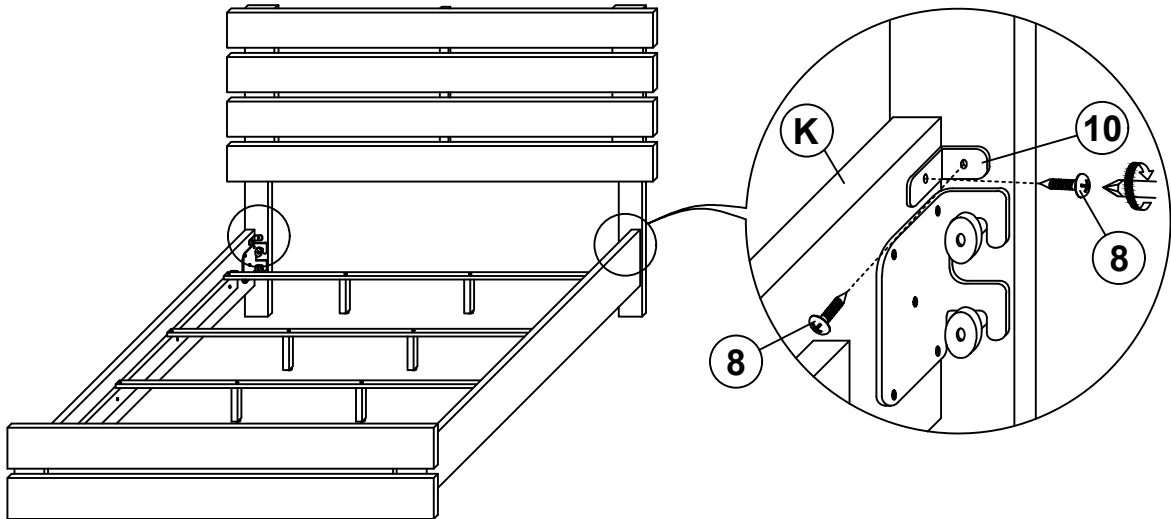

STEP 8

COMPLETE

