

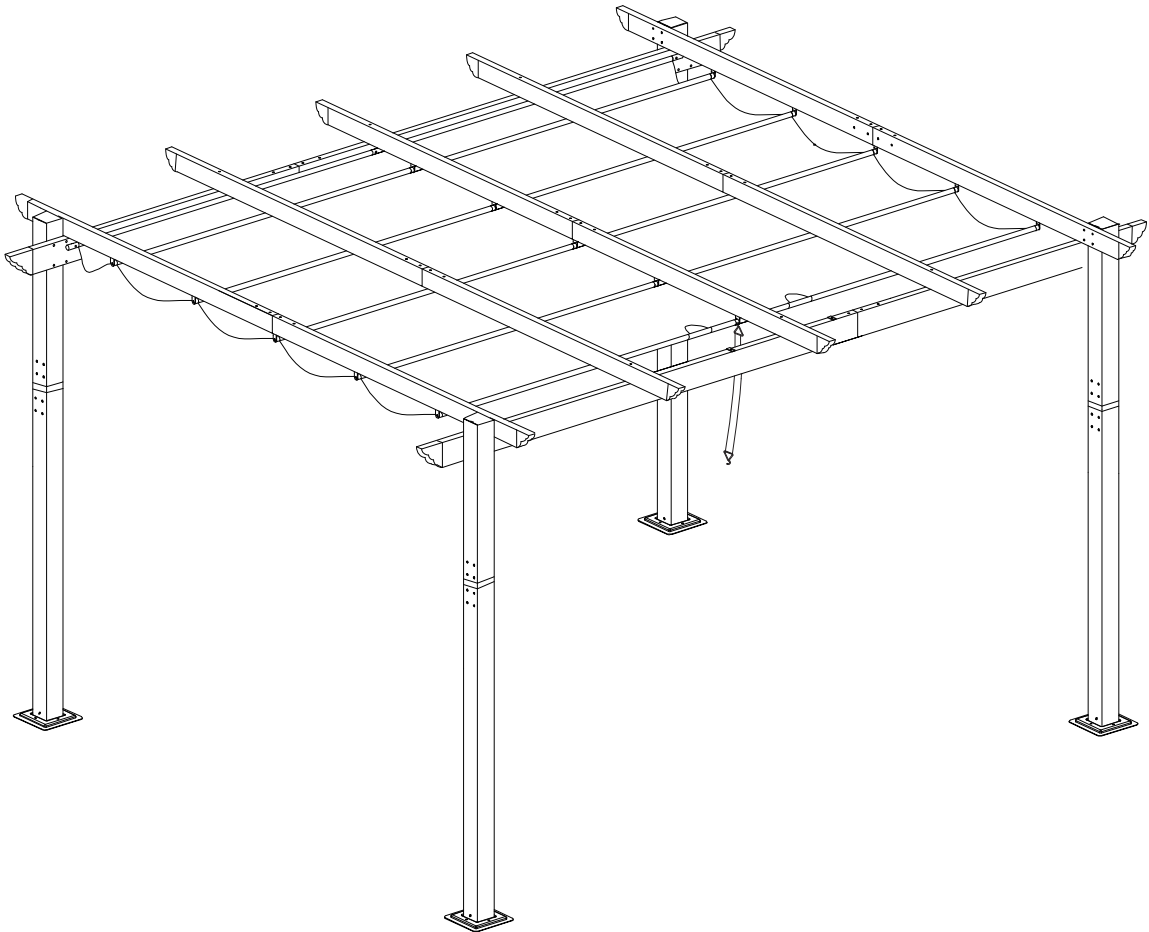

Enjoy Cozy Life!

MORGAN 10'X10' ALUMINUM PERGOLA ASSEMBLY MANUAL



KOZYARD LLC PRODUCTS

WWW.KOZYARD.COM

© Copyright 2016 - 2023 Kozyard LLC. | All Rights Reserved.
Version:20231006

Warnings and Cautions

- Please read and follow this assembly and operation guide to reduce the risk of personal injury and damage to your gazebo.
- Do not discard any of the packaging until you have checked that you have all the parts in place.
- Please close the Canopy, refraining from any damage in storm, snow, or bad weather.
- Some parts may have sharp edges or corners. To ensure your safety, follow basic safety precautions to reduce the risk of injury. Please note that this item contains small parts which could be swallowed by children. Keep it out of reach of children under 3 years old and pets during installation.



Two or more people are required for assembly and disassembly.



Do not fully tighten screw prior to complete assembly.

Pre-assembly

Tools that may be required. (Not included in boxes)

Note: Tools are not shown to actual size and scale.



Level



Phillips Screw



Drill



Allen Key







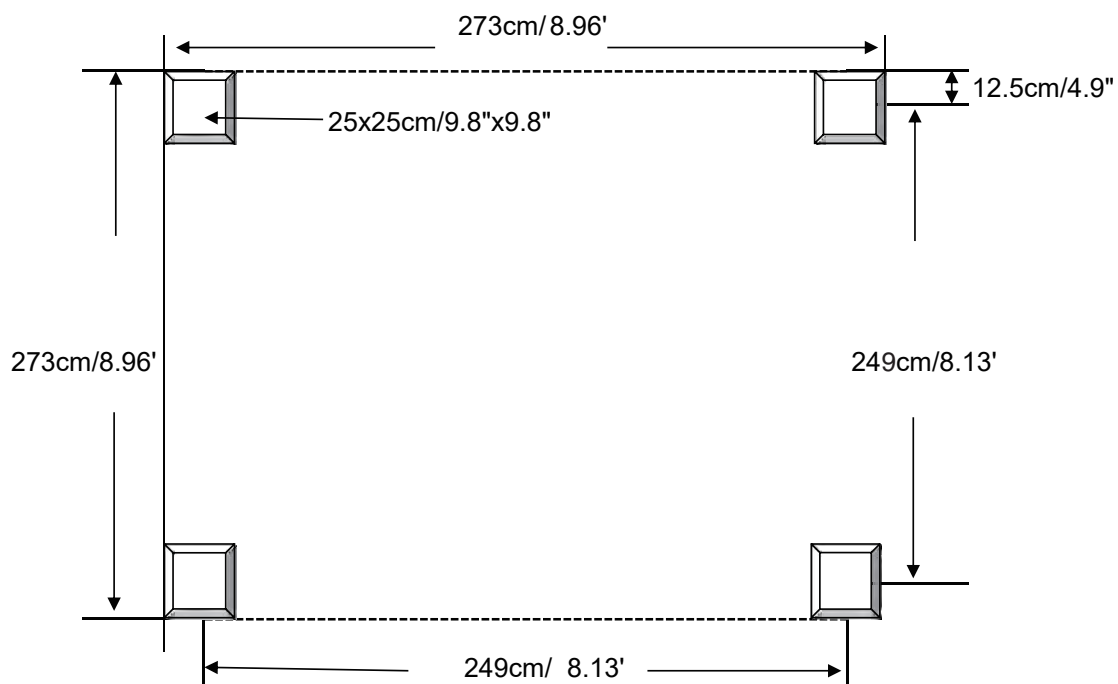





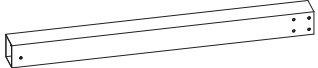
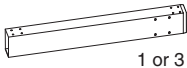
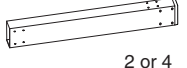





Stepladder







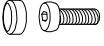
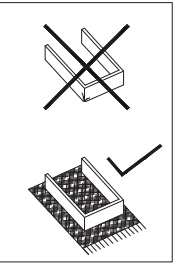

10'X10' Pergola anchore blueprint

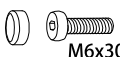
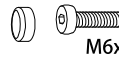

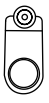
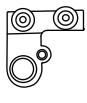
Anchoring poles into concrete is strongly recommended.
Ensure the gazebo is positioned on level ground

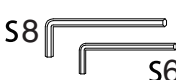

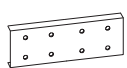
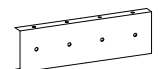

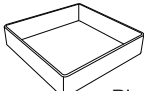

Attention: Prior to assembly, verify that all parts and pieces are included to ensure an efficient installation process.

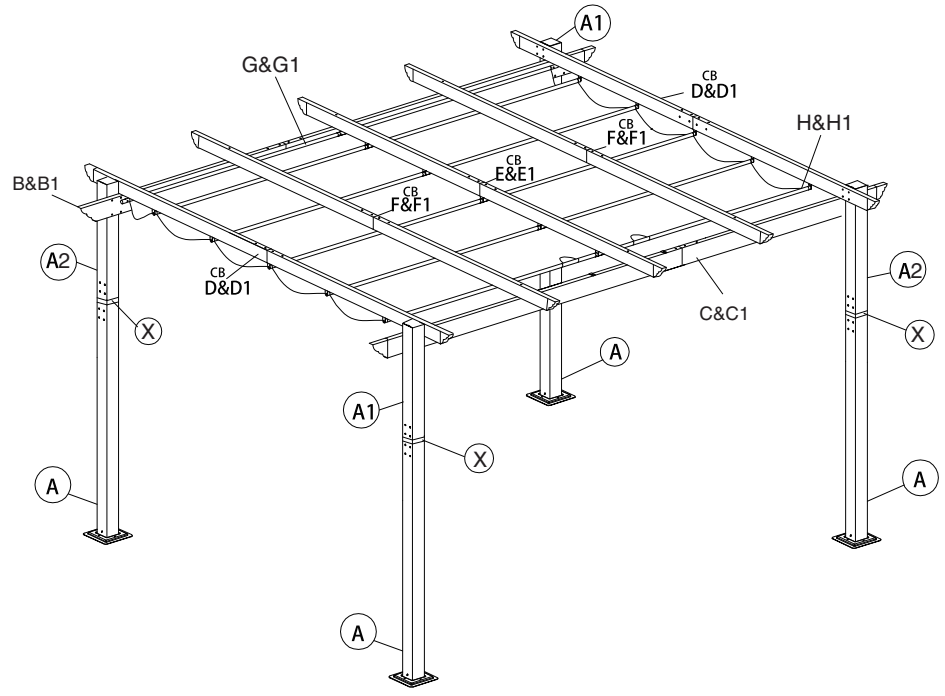
| | | | |
|------------|--|---|--|
| Parts list |  A 4X Pole |  A1 2X 1 or 3 Position Short Pole |  A2 2X 2 or 4 Position Short Pole |
| |  B 1X Side Tube |  B1 1X Side Tube | |
| |  C 1X Side Tube |  C1 1X Side Tube | |
| |  D 2X Side Track Tube |  D1 2X Side Track Tube | |
| |  E 1X Middle Track Tube |  E1 1X Middle Track Tube | |
| |  F 2X Beam Tube |  F1 2X Beam Tube | |
| |  G 1X Still Round Tube |  G1 1X Still Round Tube | |
| |  H 5X Moveable Round Tube |  H1 5X Moveable Round Tube | |
| |  I 4X Plate |  J 140X+5X Bolt M6x16 | |
| |  | | |

| | | | |
|---|--|--|---|
|  M6x30 Bolt (K) 3X+1X |  M6x85 Bolt (L) 6X+1X |  M6x15 Bolt (M) 32X+2X |  (N) 10X Hook |
|  (O) 4X Hook |  (P) 1X Hook |  (R) 2X Lock |  (S) 1X Canopy |
|  S8 S6 Allen Key (Q) 1X |  Ribbon (T) 1X |  (U) 16x+2x |  Connector (V) 8x |
|  Connector (V1) 2x |  Connector (V2) 5x |  Plastic Cover (X) 4x | |

OVERALL

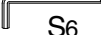

-  (A) 4X
-  (A1) 2X
-  (A2) 2X
-  (X) 4X
-  (V) 8X
-  (J) 64X
M6x 16
-  (Q) 1X
S6

Step 1:

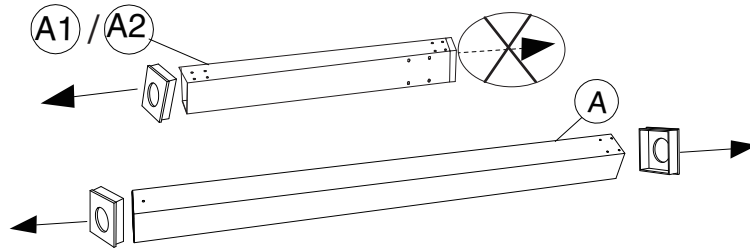

First, remove the plastic plugs from Part A1/A2 and Part A.

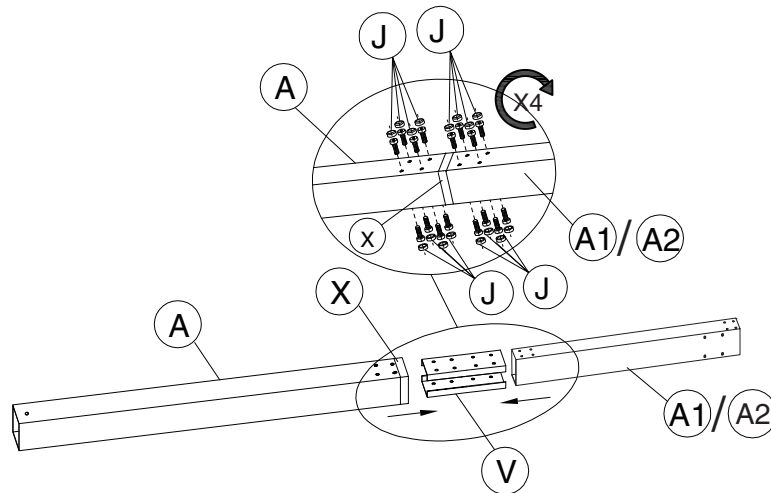

Then, place Part X on the four poles (Part A) and connect A and (A1 or A2) by using Bolt J to attach the four poles.

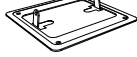

Do not tighten the bolts too much when inserting A into A1 and A2.

-  (I) 4X
-  (J) 8X
M6x 16
-  (Q) 1X
S6

Step 2:

Connect Part I to the poles using Bolt J.

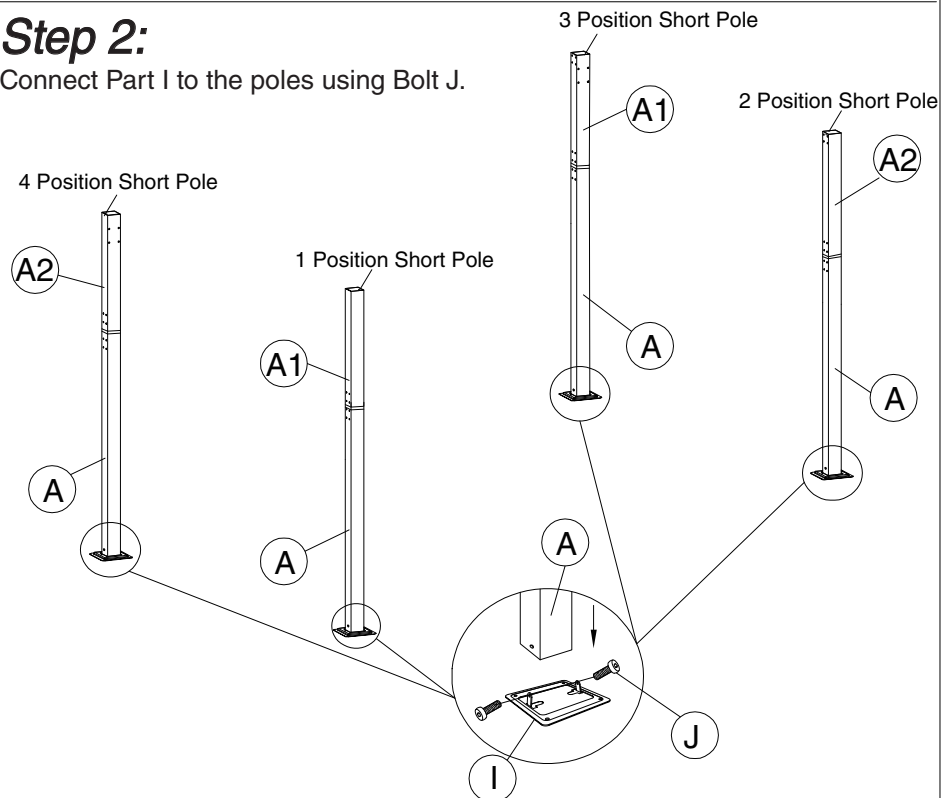

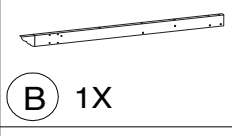

B 1X

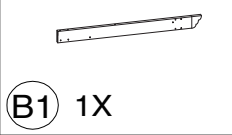

B1 1X

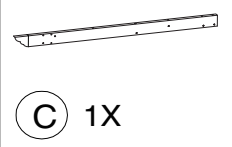

C 1X

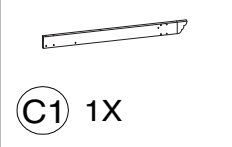

C1 1X

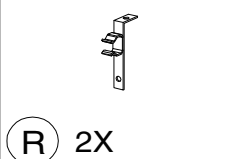

R 2X

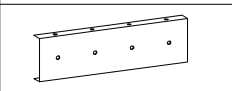

V1 2x

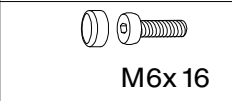

M6x16

J 18X



S6

Q 1X

Step 3:

Connect Part B and Part B1 using Bolt J to assemble Main Beam 1.

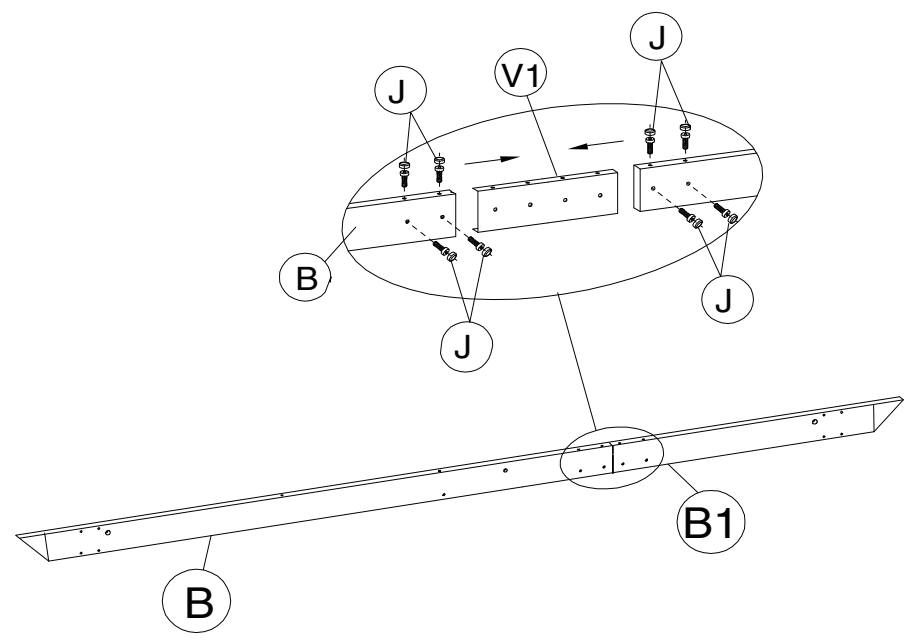

Connect C and C1 using Bolt J to assemble Main Beam 2. Simultaneously, attach Part R to C using Bolt J.

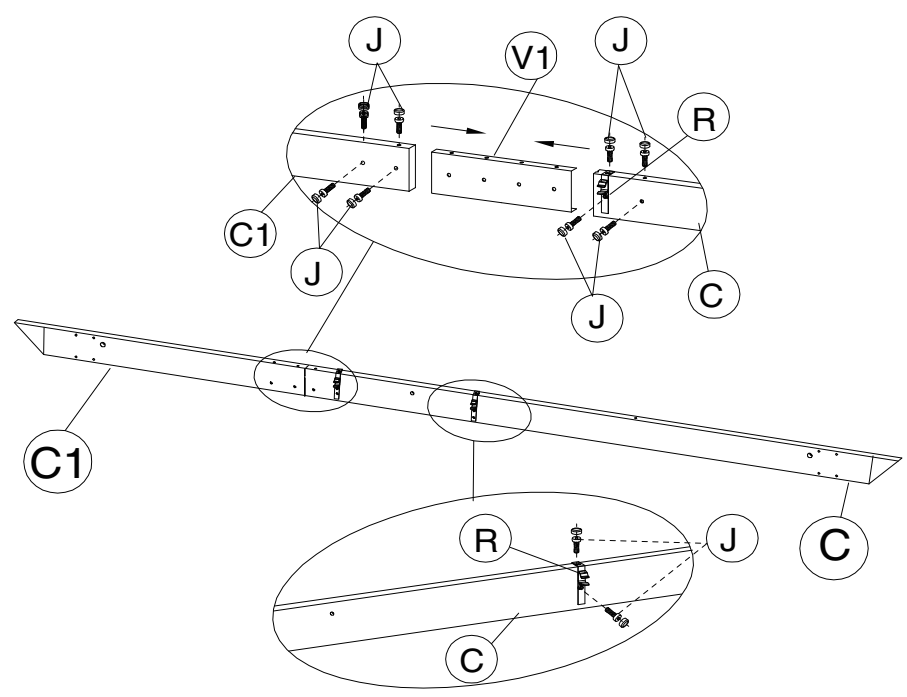

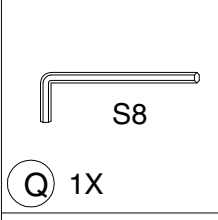
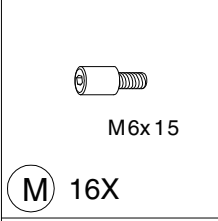

Step 4:
Connect Main Beam 1 and Main Beam 2 to the four Poles using Bolt M.

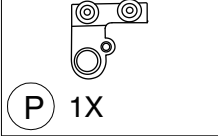
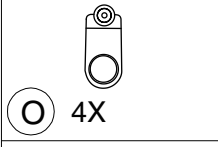
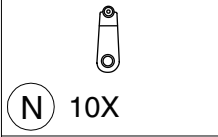
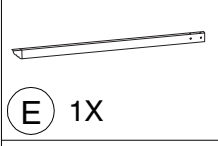
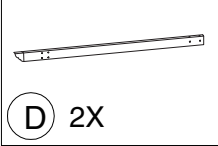
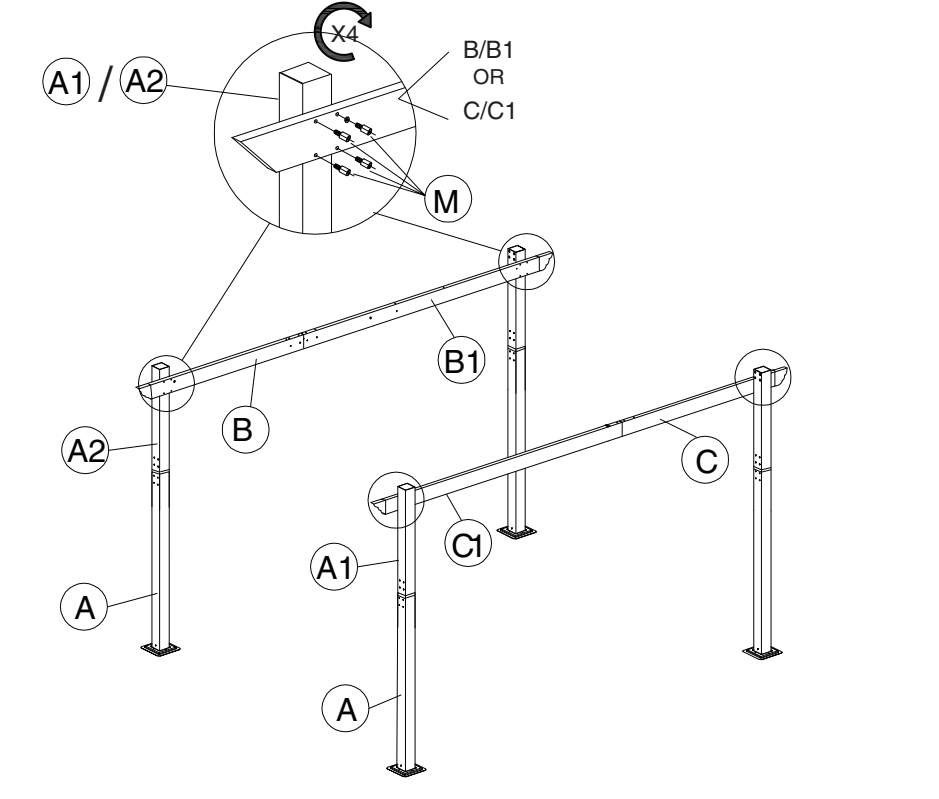

Step 5:
1. Insert Hook Part N into the slot of Part D. Repeat twice.

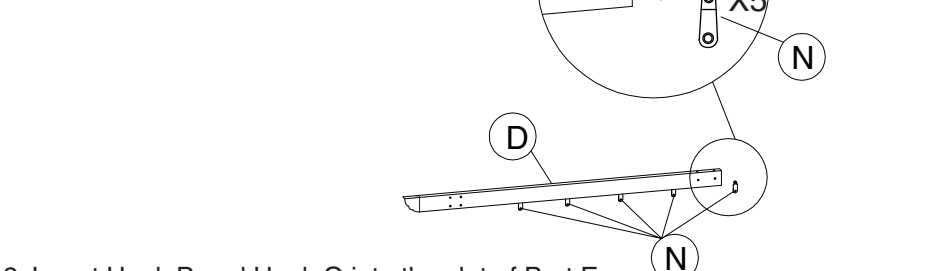

2. Insert Hook P and Hook O into the slot of Part E.
• Please ensure that Hook P is inserted according to the method shown in the diagram and not the opposite way.

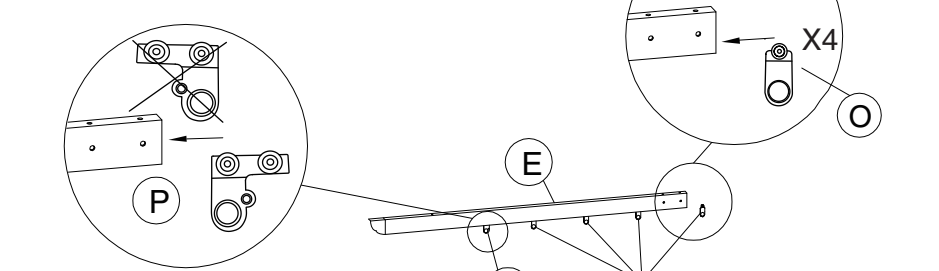

Note: Keep Hook P and C1/C2/C on the same side of Part E.



D 2X



D1 2X



V2 2x

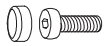

M6x16

J 16X

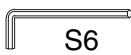

S6

Q 1X

Step 6:

Connect D and D1 to assemble the Cross Beam (D and D1) using Bolt J.

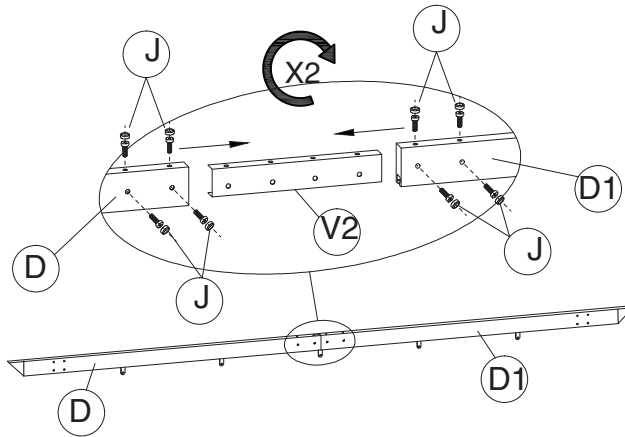

Step 7:

Connect the Cross Beam (D and D1) to the four Poles using Bolt M.



M6x15



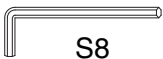



M 16X

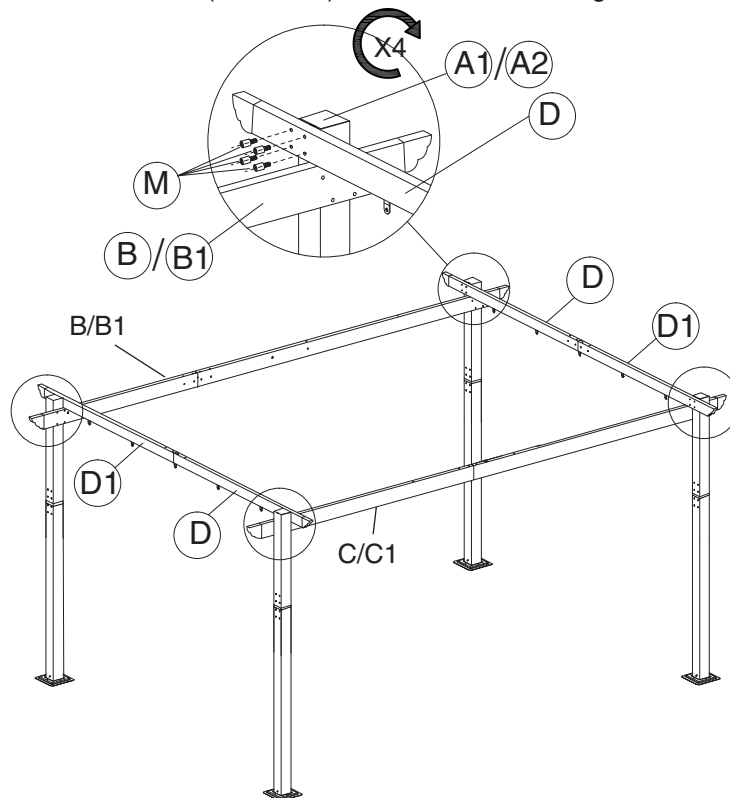

S8

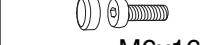

Q 1X

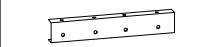

-  **E** 1X
-  **E1** 1X
-  **F** 2X
-  **F1** 2X
-  **J** 24X
M6x16
-  **Q** 1X
S6
-  **V2** 3X

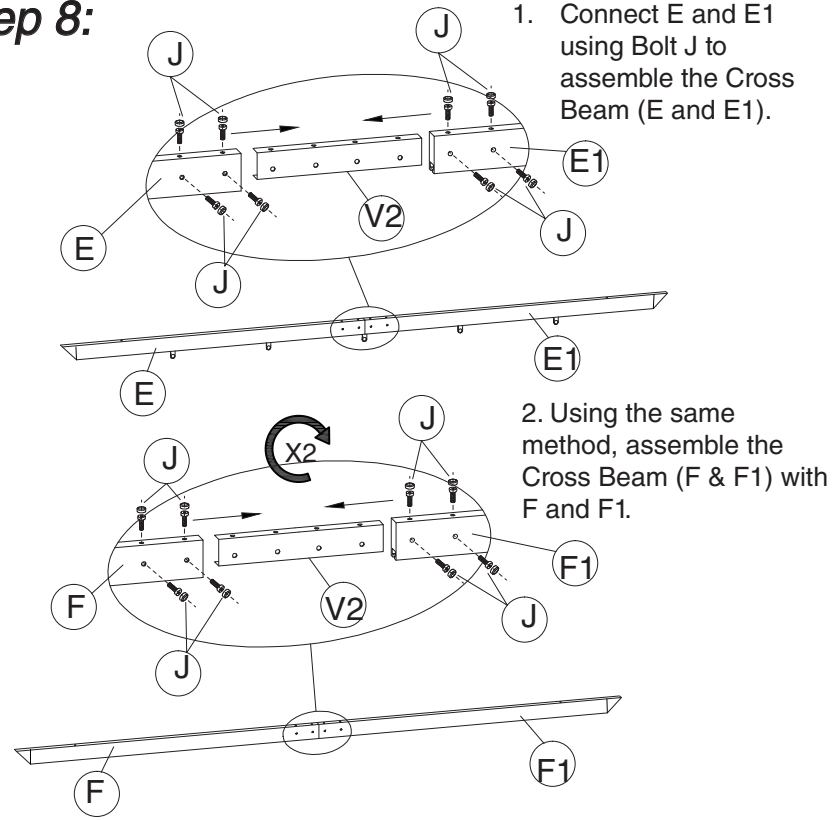
Step 8:

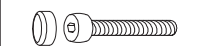

-  **L** 6X
M6x85
-  **Q** 1X
S6

Step 9:

Connect the Cross Beams (E and E1) and (F and F1) to Main Beams 1 and 2.
Please ensure that Hook P and C/C1 remain on the same side.

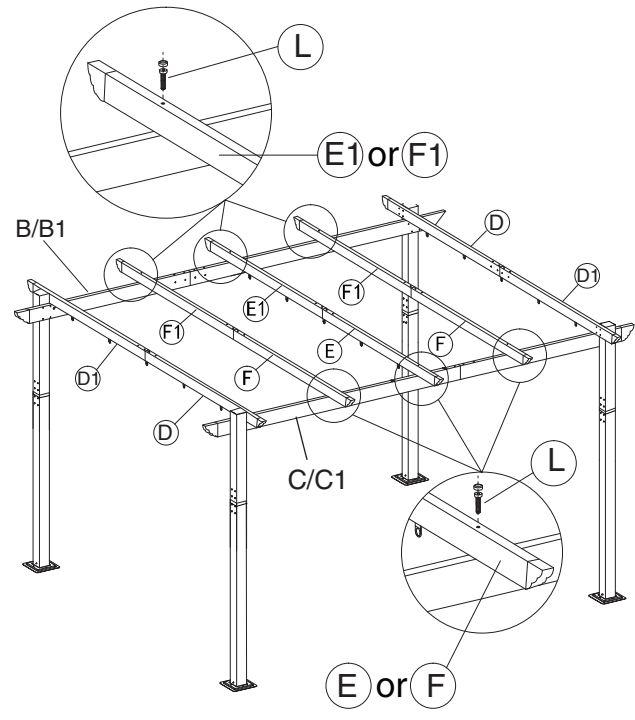

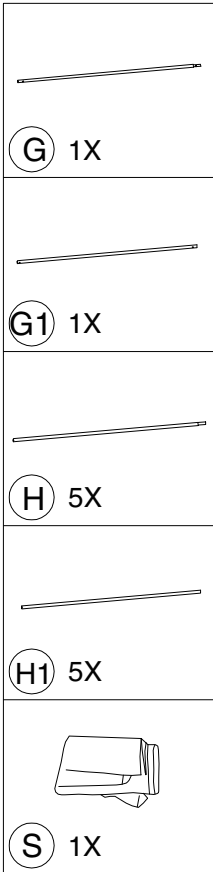

Step 10:

Insert G, G1, H, and H1 into the canopy from the side.

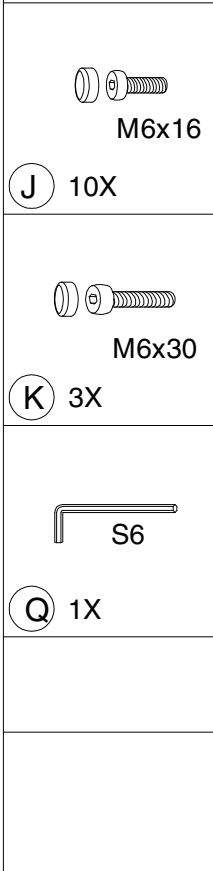
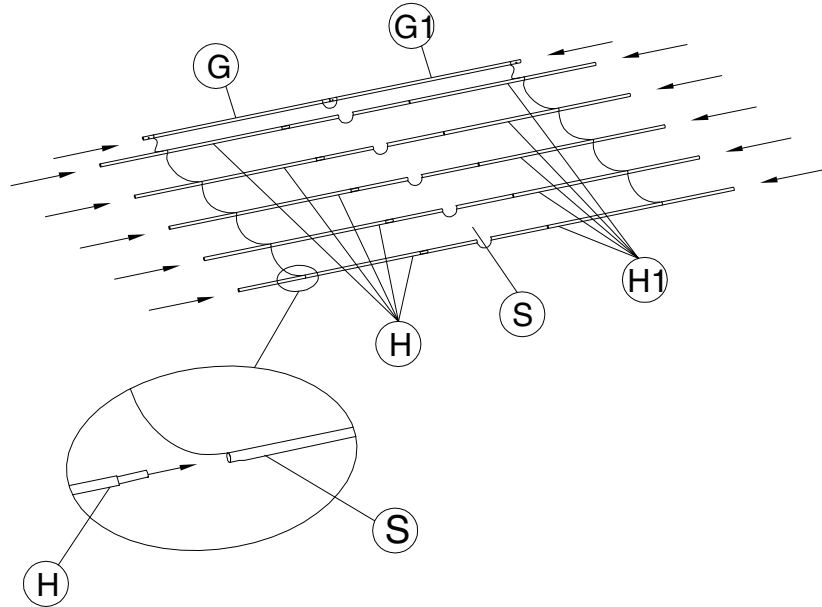

Step 11:

Connect G and G1 to B and B1 using bolt K, and secure the canopy with the frames.

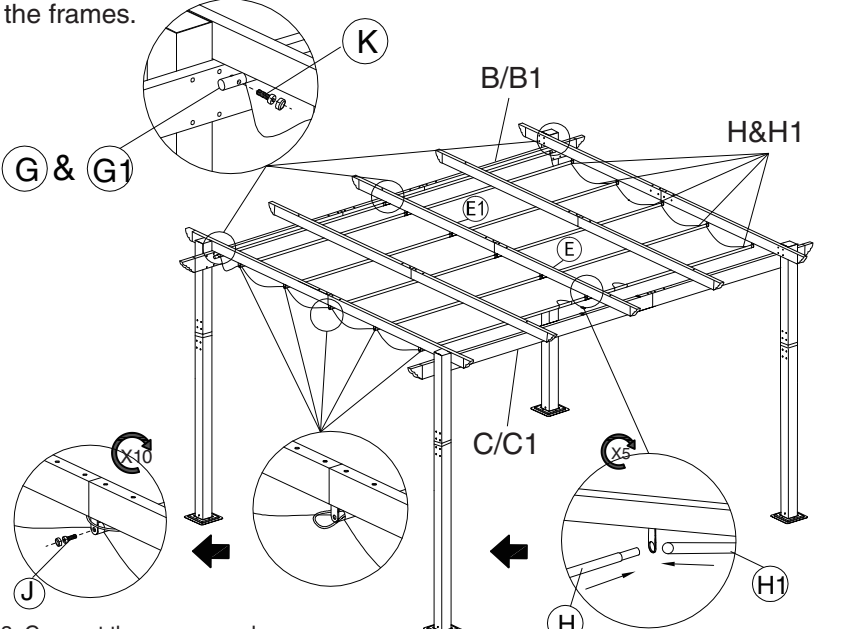

1. Connect H and H1 through the hook
2. Pull the line from the canopy and put on hook to tighten the canopy.
3. Connect the canopy and the Hook using Bolt J

T 1X

Step 12:

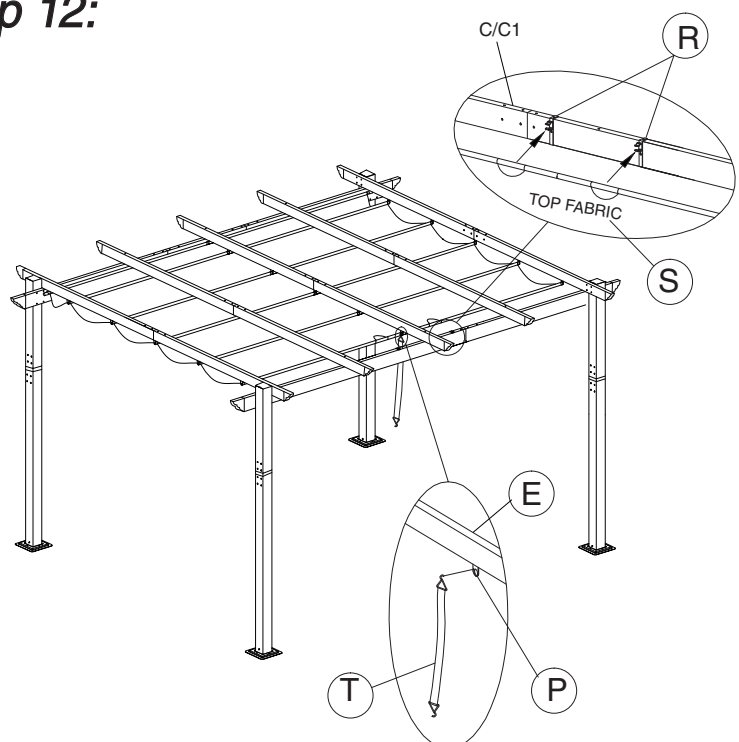

Hang Part T on Hook P

Step 13:

Secure Part T to beam B/B1 to attach the Top Fabric.

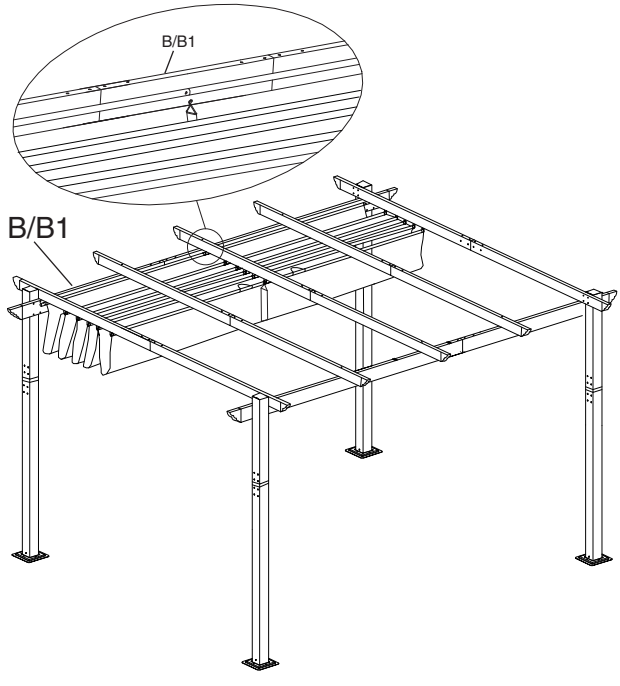

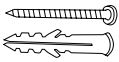

U 16X

Step 14:

Secure Foot I to the ground using Part U.

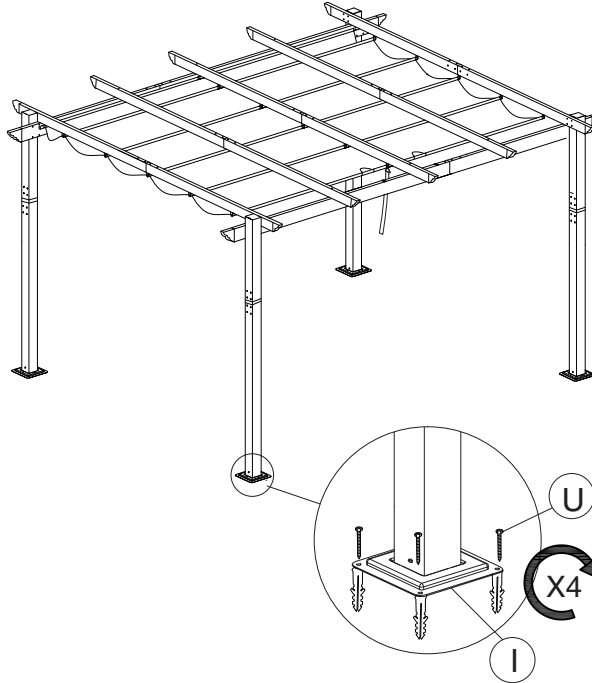

Step 15:

Before use, ensure that all screws are completely tightened.

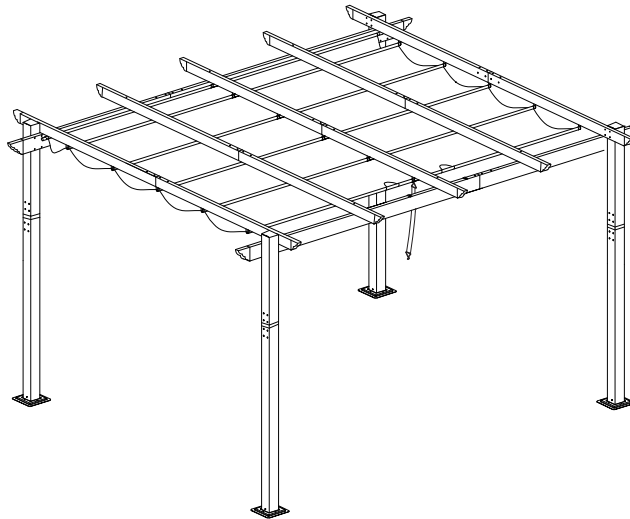



Enjoy Cozy Life!

As expert manufacturer of outdoor furniture, Kozyard remains committed to supporting you with parts and replacements, even beyond your warranty period. Don't hesitate to contact us directly if you are missing parts or need a replacement.

SUPPORT:

Toll free: 1-866-355-0018

www.kozyard.com

email: support@kozyard.com

SOCIAL MEDIA:



Follow us on Instagram

www.instagram.com/kozyard

KOZYARD LLC