

# ASSEMBLY INSTRUCTIONS

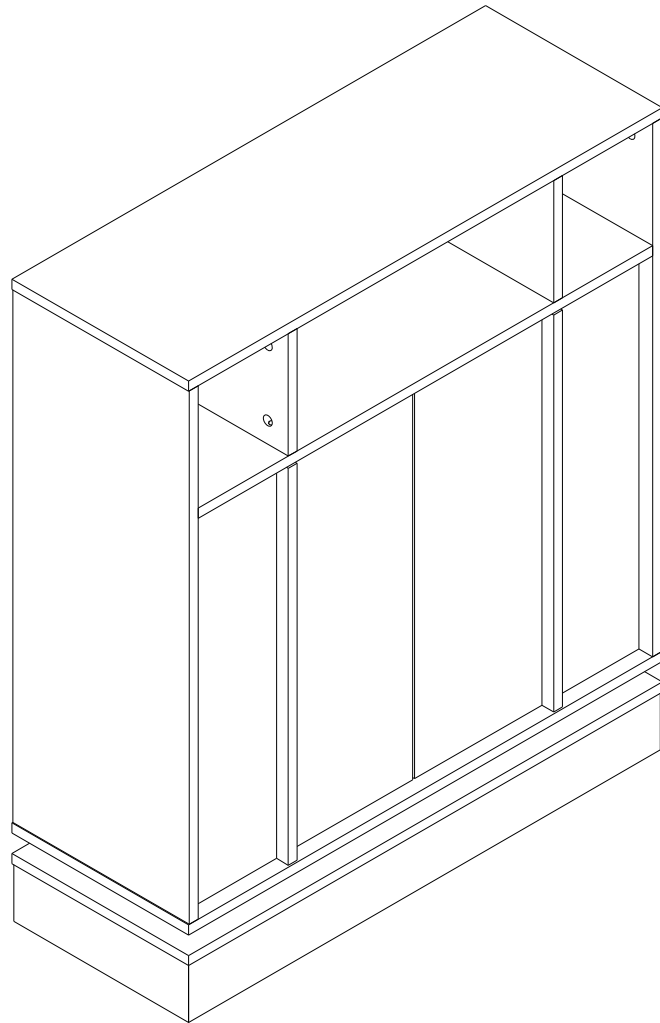

## Notice:

1. Follow the installation instructions. Please confirm all accessories are preset before installation.
2. Do not fully tighten the screws during initial assembly. Fully tighten screws only once all pieces which are correctly assembled.
3. If you encounter any problems during installation, please contact our customer service.
4. Please unbox the item from the side with an open-label and put a carpet on the floor to avoid scratching it.

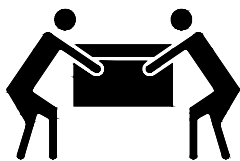

Recommended installers:2

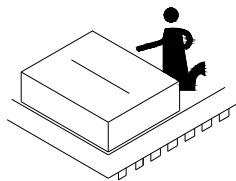

Put a carpet on the floor  
before unpacking

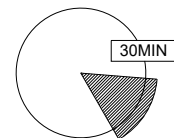

Estimate installation time:  
30minutes





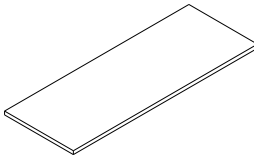
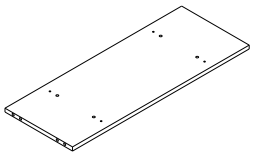
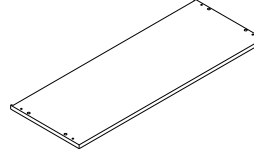
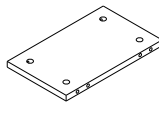
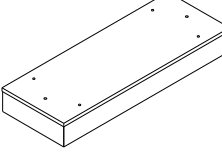
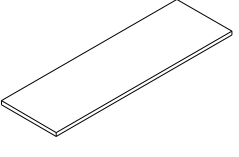
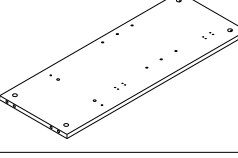
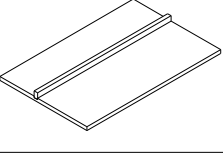
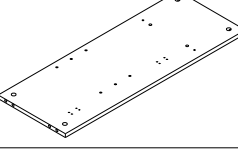
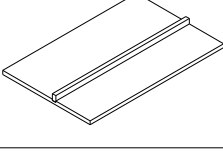
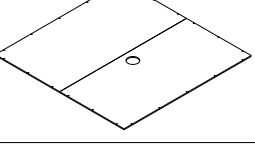





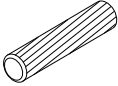

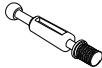
# ASSEMBLY INSTRUCTIONS

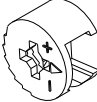
## PART LIST

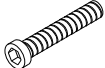
Item no.	Reference Image	Qty		Item no.	Reference Image	Qty
Ⓐ		X1		Ⓕ		X1
Ⓑ		X1		Ⓖ		X2
Ⓒ		X1		Ⓖ		X1
Ⓓ		X1		Ⓖ		X1
Ⓔ		X1		Ⓖ		X1
				Ⓖ		X1

# ASSEMBLY INSTRUCTIONS

## HARDWARE LIST

Item no.	Reference Image	Qty	Item no.	Reference Image	Qty
1	 Ø8*30mm	X24+2	7	 Ø3*15mm	X21+2
2		X20+2	8		X4
3		X20+2	9		X4
4	 Ø1/4"*1-1/4"	X2	10	 Ø3*14mm	X24+2
5		X2	11		X1
6		X2	12		X1

# ASSEMBLY INSTRUCTIONS

---

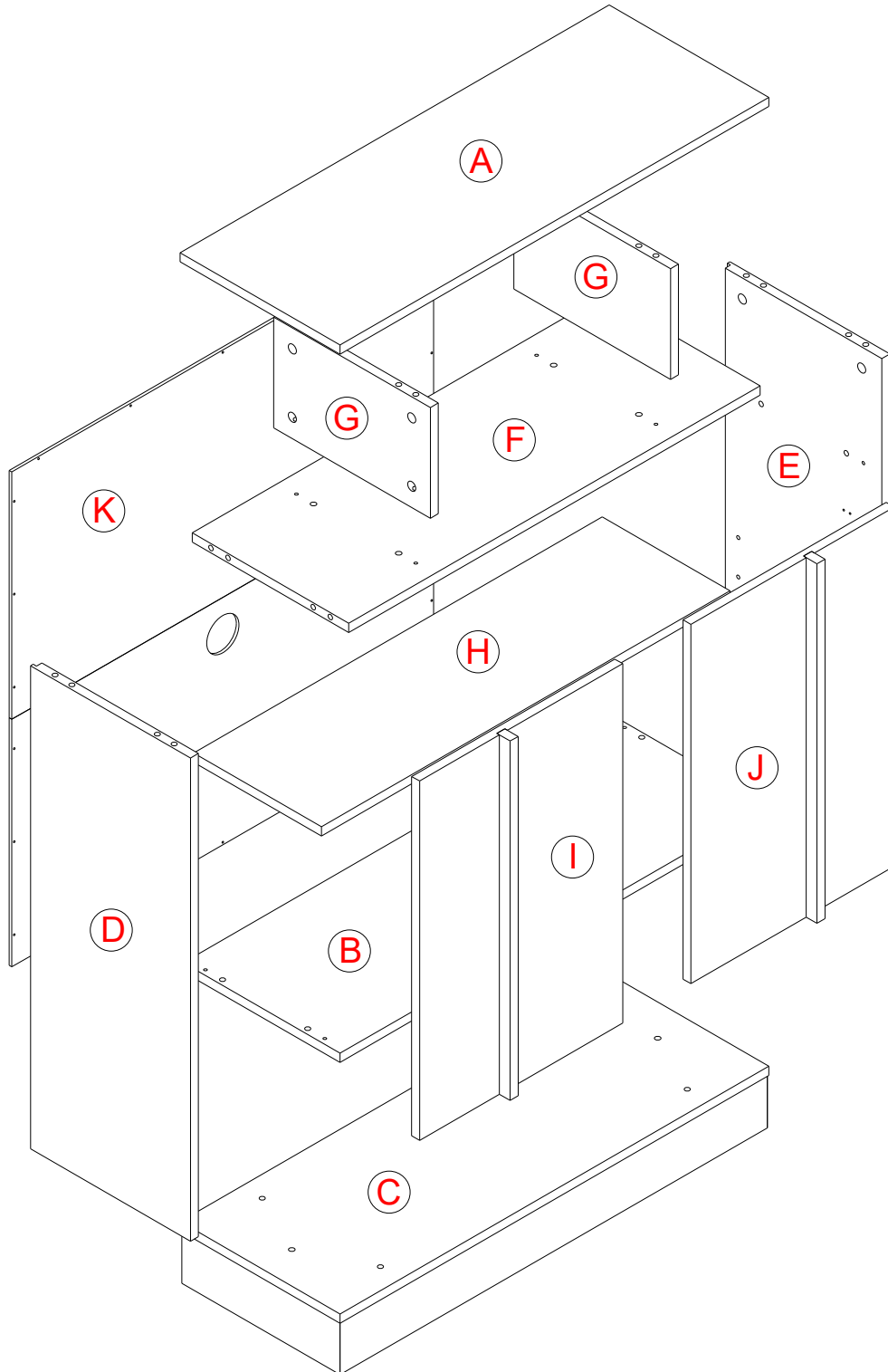

# ASSEMBLY INSTRUCTIONS

1

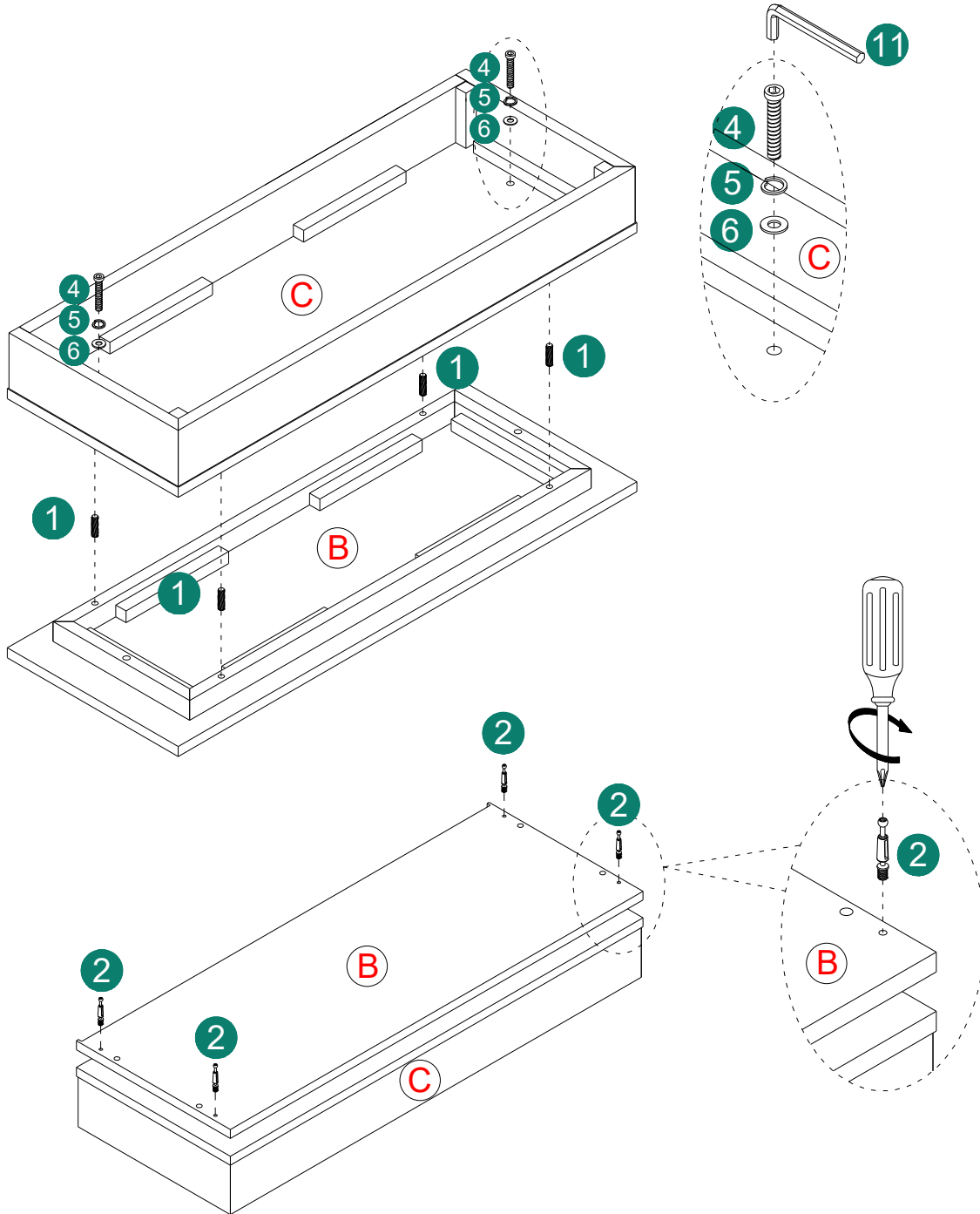
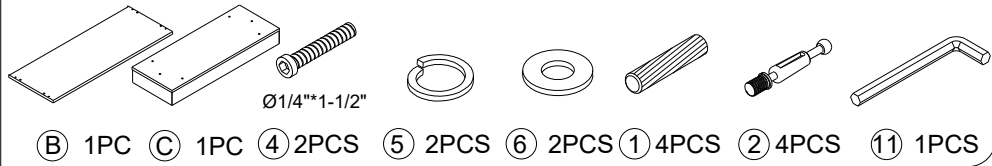

# ASSEMBLY INSTRUCTIONS

2

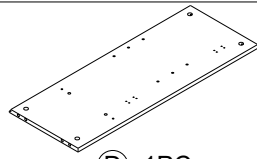

Ⓓ 1PC

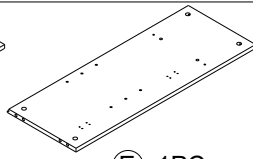

Ⓔ 1PC

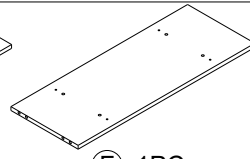

Ⓕ 1PC



② 8PCS

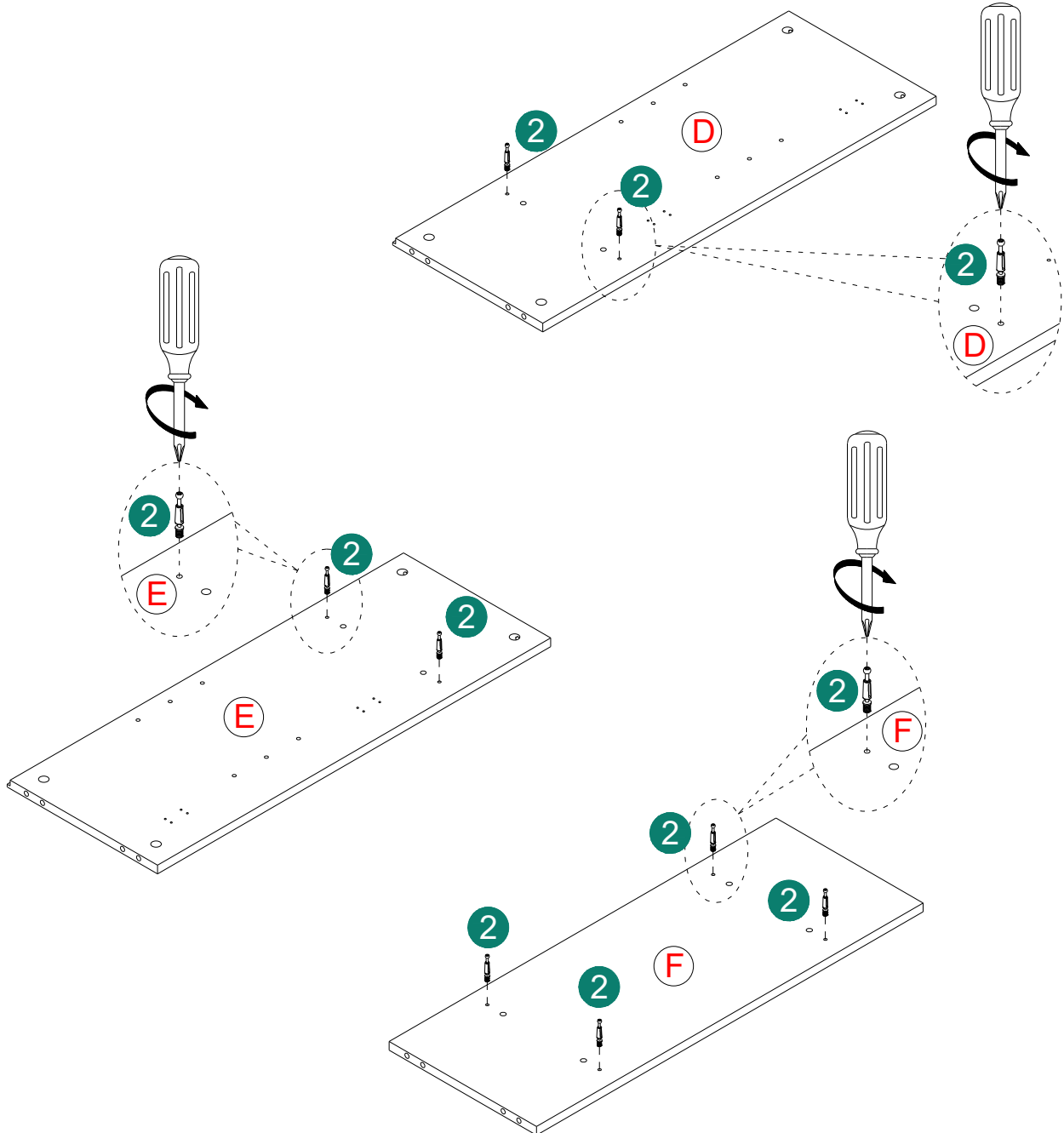

# ASSEMBLY INSTRUCTIONS

3

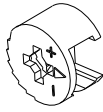

③ 8PCS

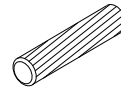

① 8PCS

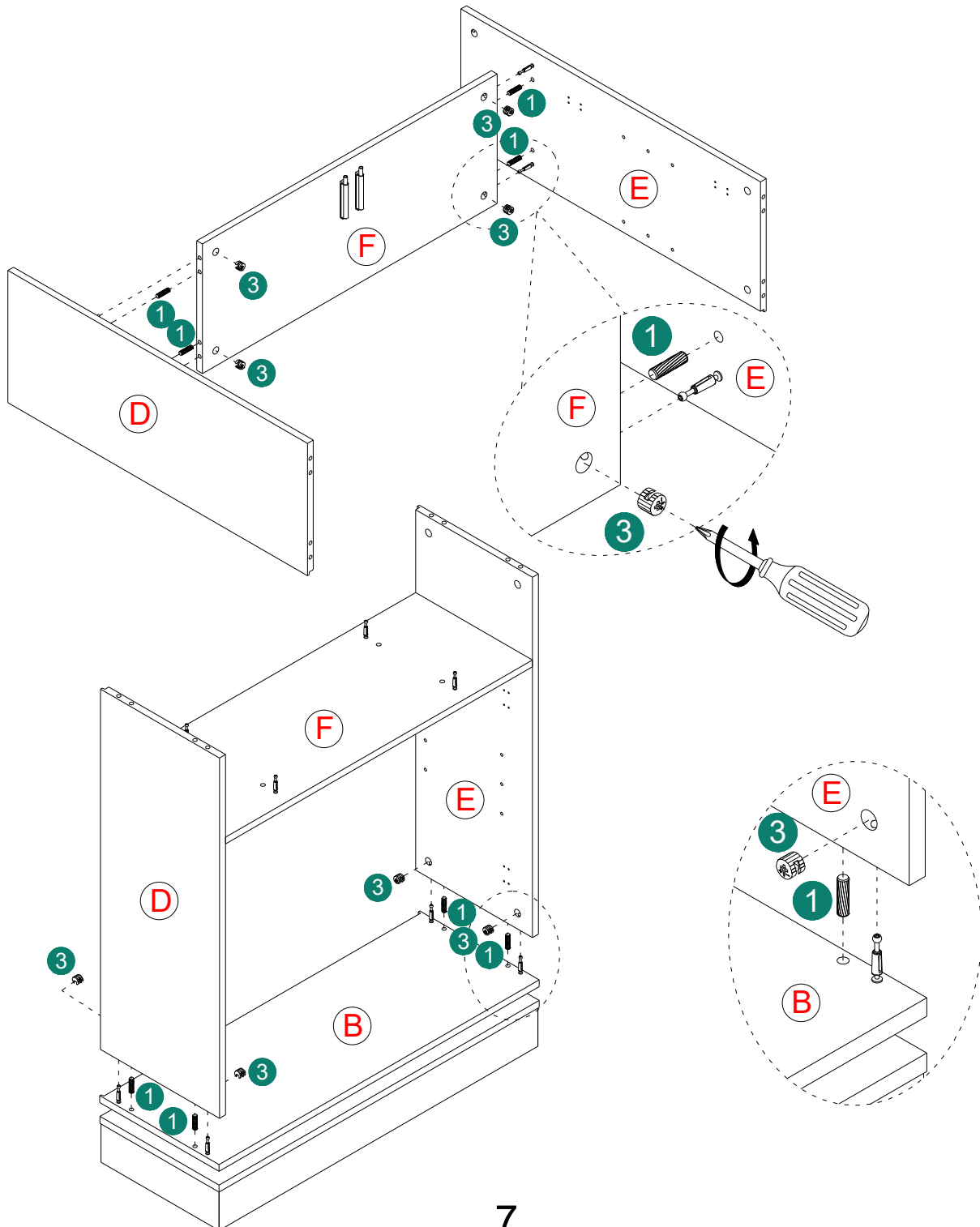

# ASSEMBLY INSTRUCTIONS

4

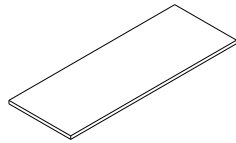

(A) 1PC

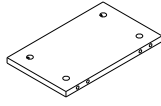

(G) 2PC

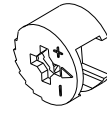

(3) 4PCS

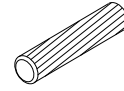

(1) 4PCS



(2) 8PCS

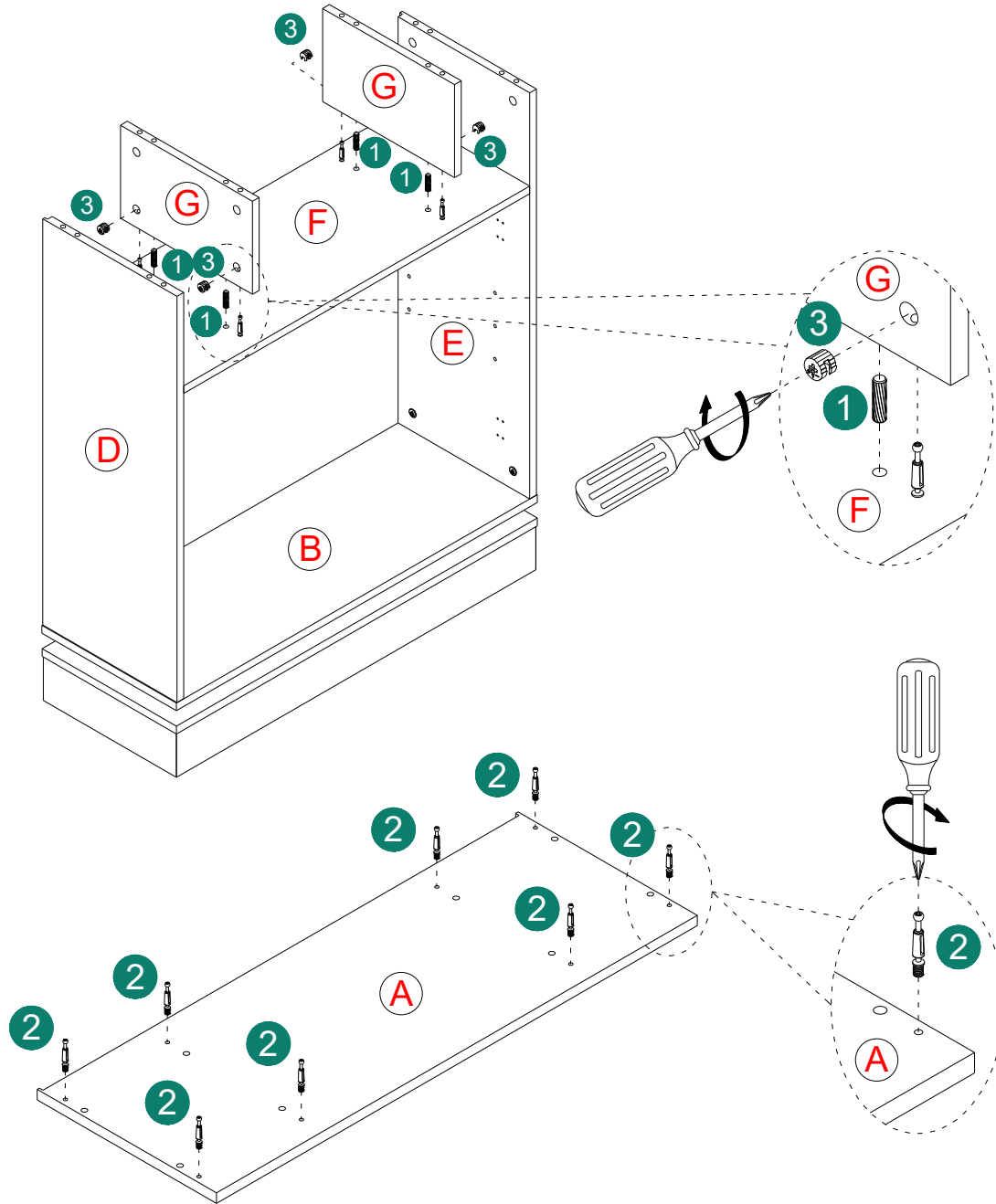

# ASSEMBLY INSTRUCTIONS

5

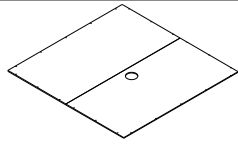

(K) 1PC

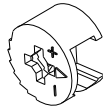

(3) 8PCS

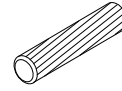

(1) 8PCS



Ø3\*15mm  
(7) 21PCS

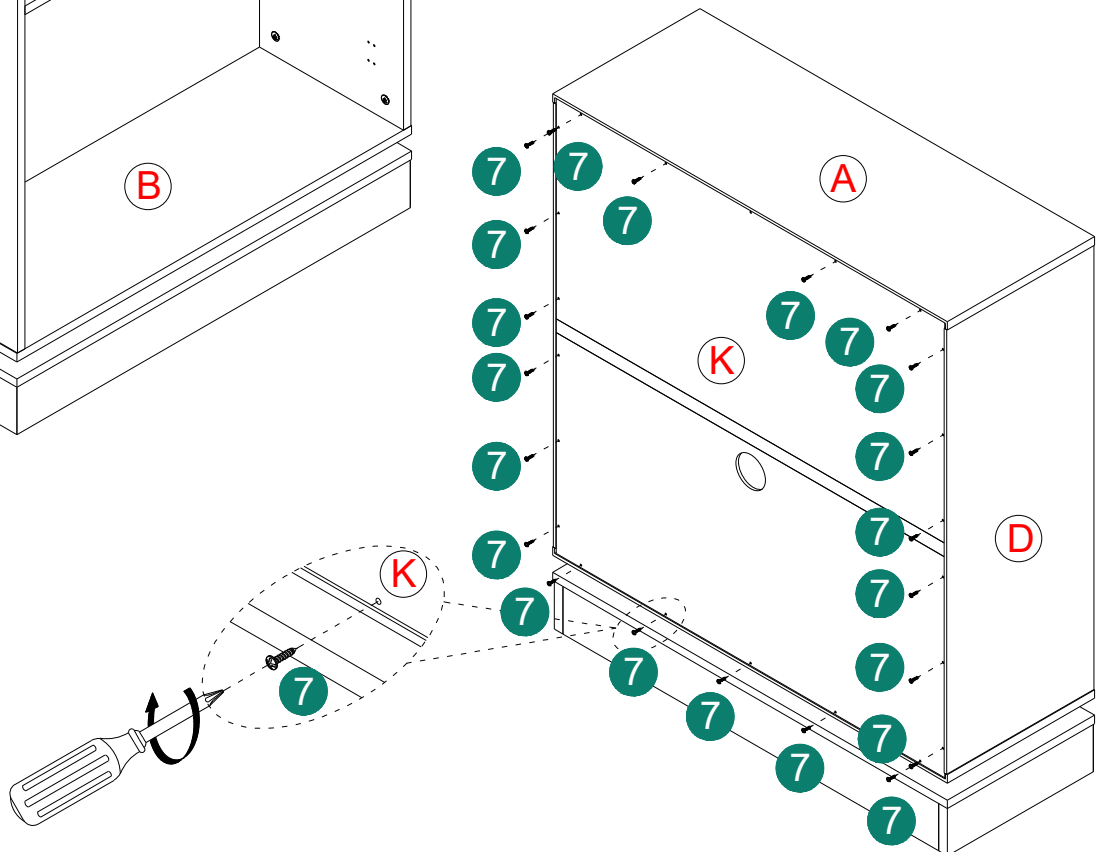
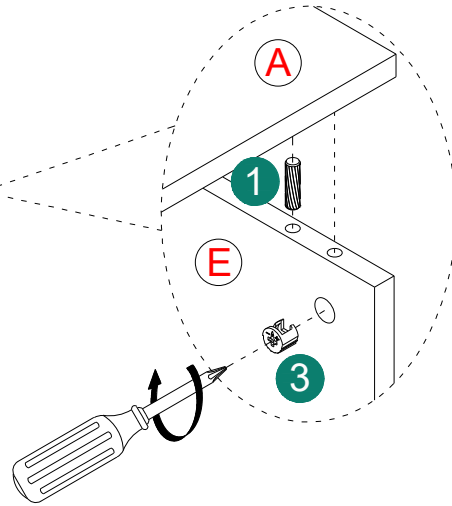
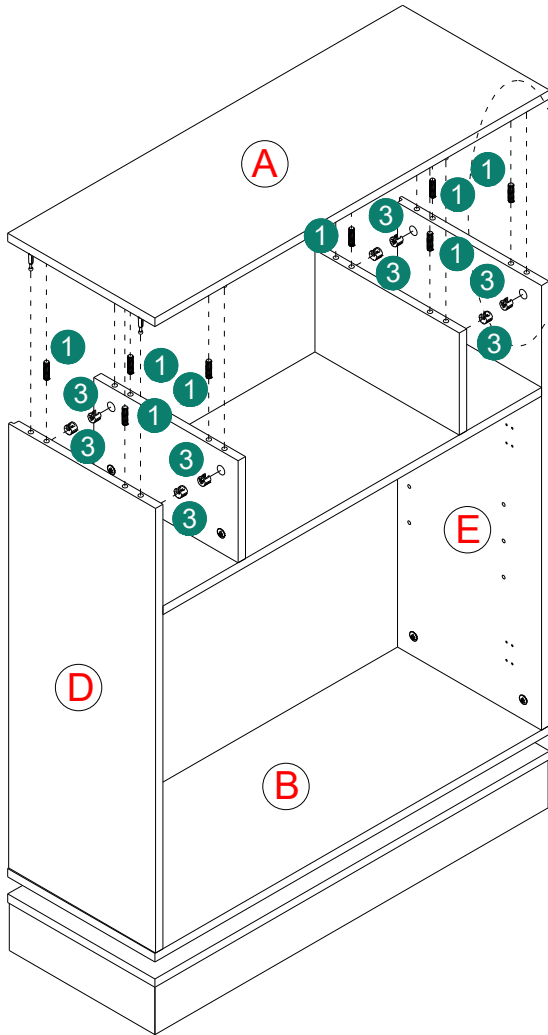

# ASSEMBLY INSTRUCTIONS

6

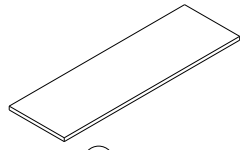

(H) 1PC



(8) 4PCS

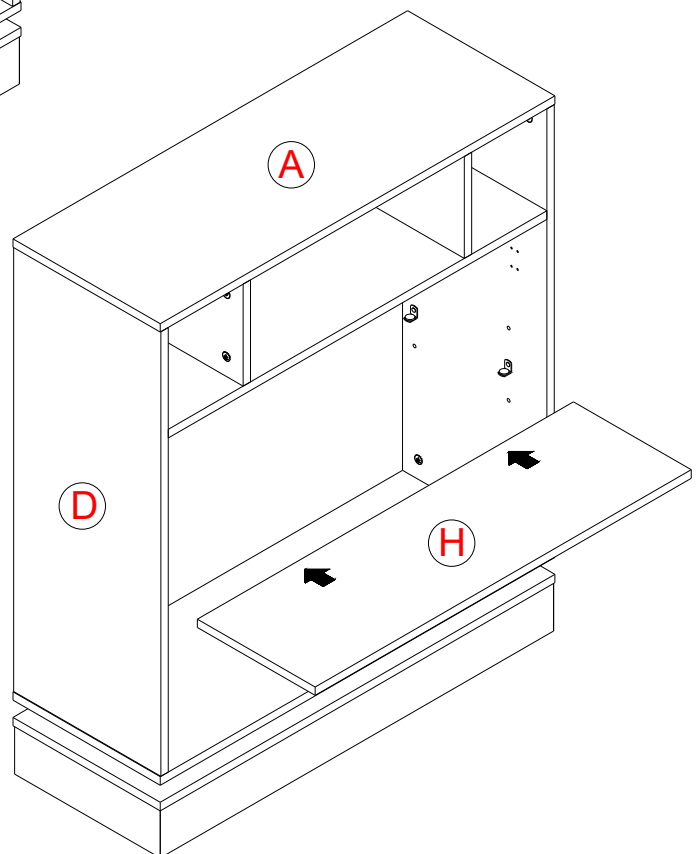
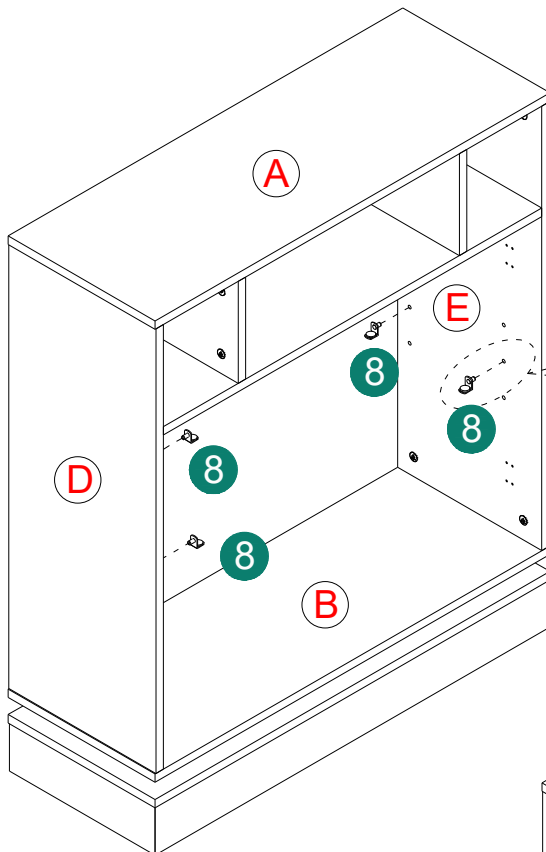

10

# ASSEMBLY INSTRUCTIONS

7

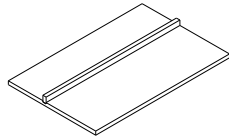

I 1PC

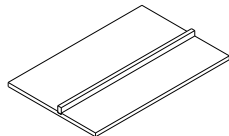

J 1PC

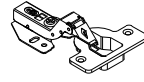

9 4PCS



Ø3\*14mm

10 8PCS

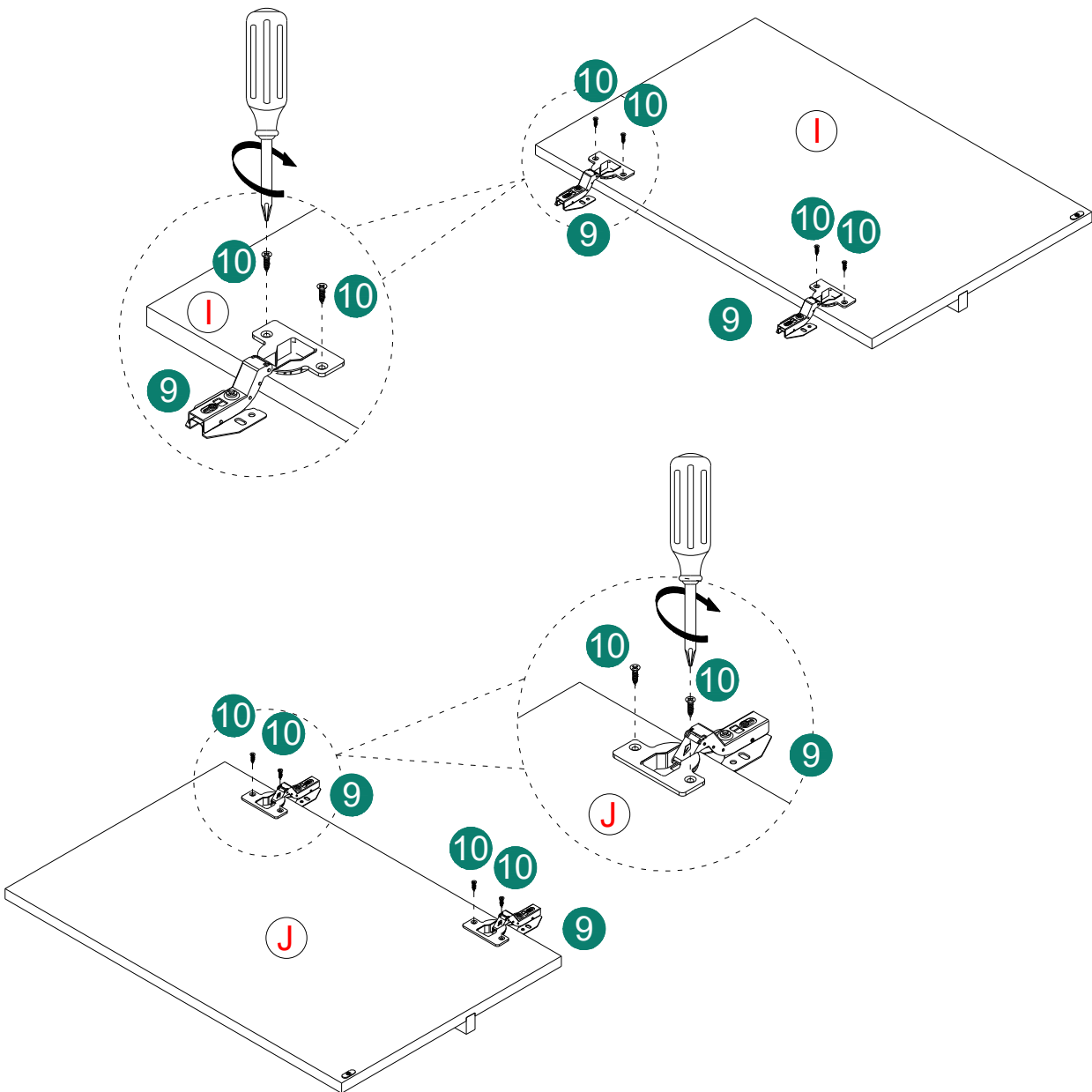

# ASSEMBLY INSTRUCTIONS

8



Ø3\*14mm

10 16PCS

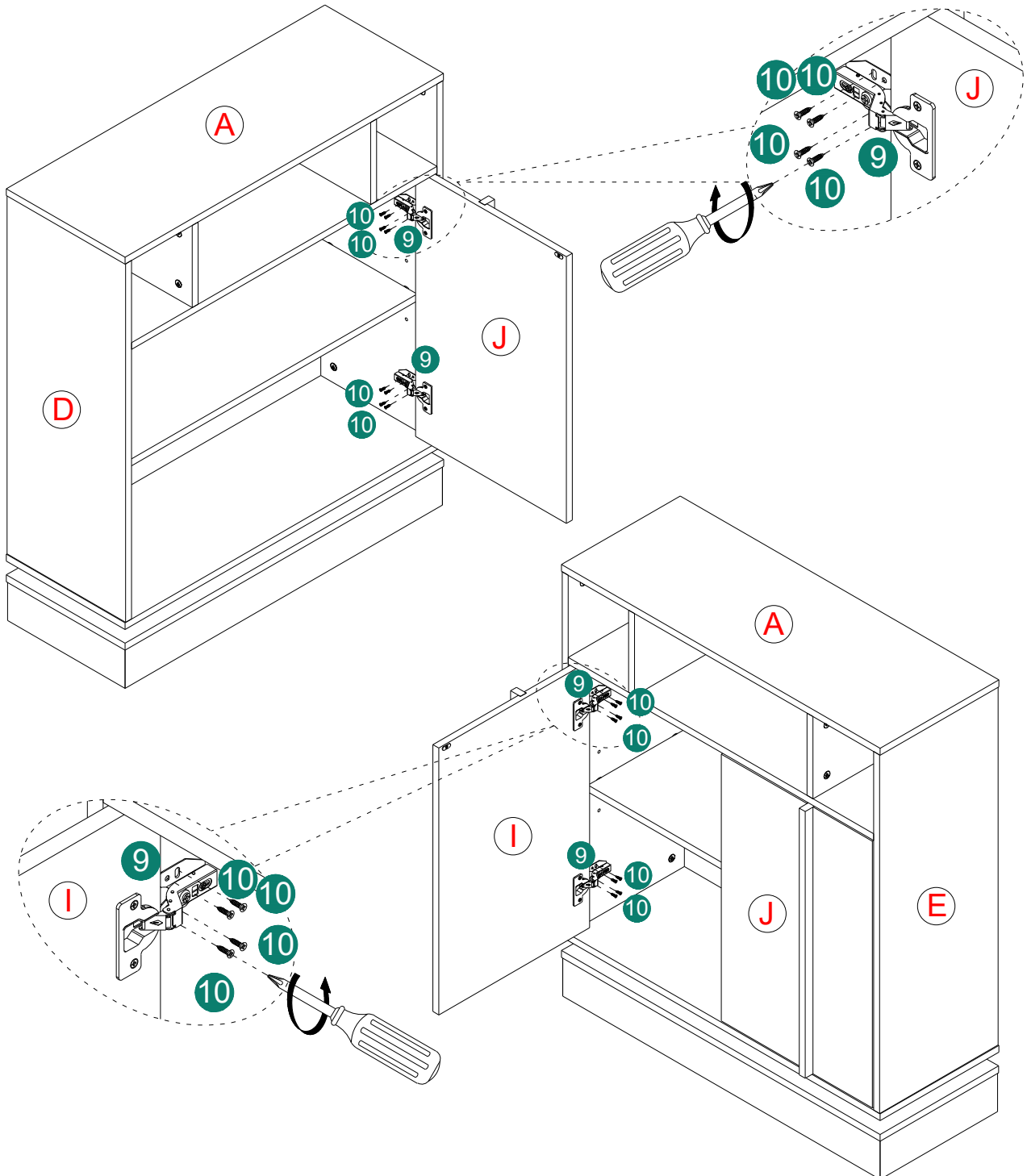

# ASSEMBLY INSTRUCTIONS

9

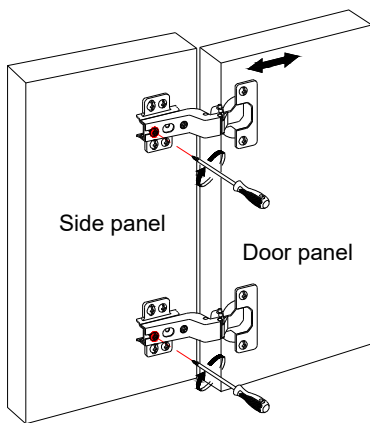

①

## Front-to-Back Direction Adjustment:

Rotate the screws on the door hinges shown in the image. The door panel can be moved front-back.

Adjustment range: 4mm

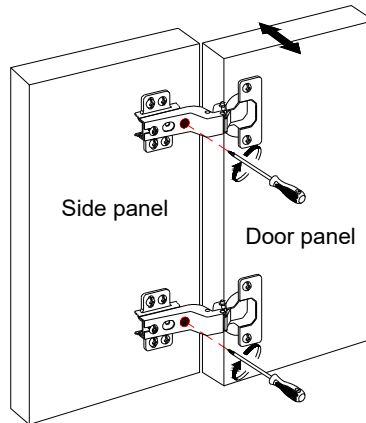

②

## Left-Right Direction Adjustment:

Rotate the screws on the door hinges shown in the image. The door panel can be moved left-right.

Adjustment range: 3mm

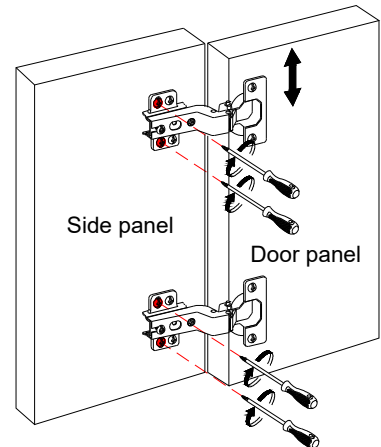

③

## Up-Down Direction Adjustment:

Rotate the screws on the door hinges shown in the image. The door panel can be moved up-down.

Adjustment range: 4mm

# ASSEMBLY INSTRUCTIONS

10

## Common Door Panel Issues:

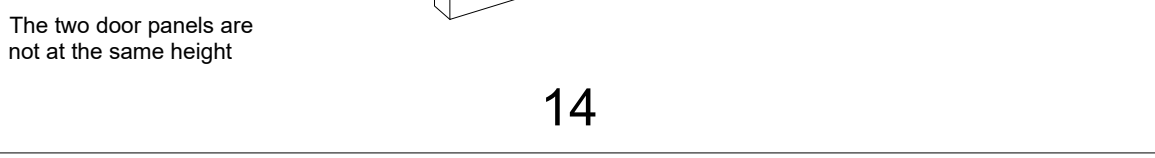
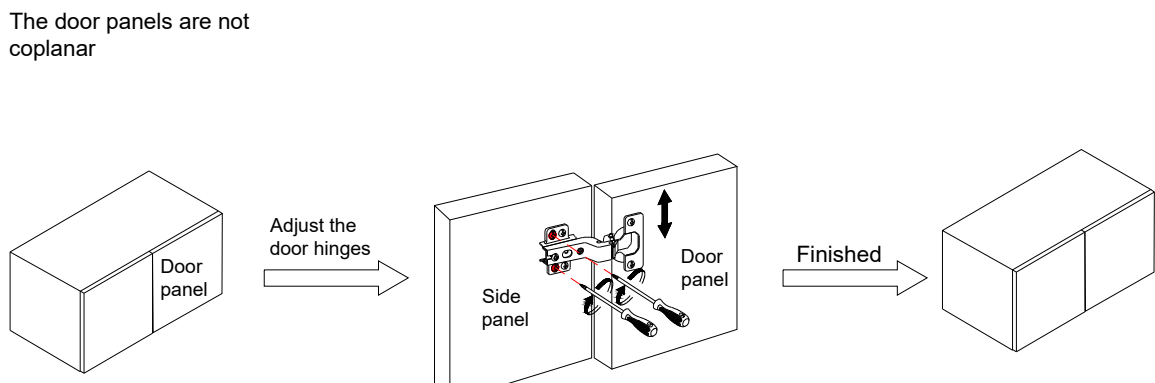
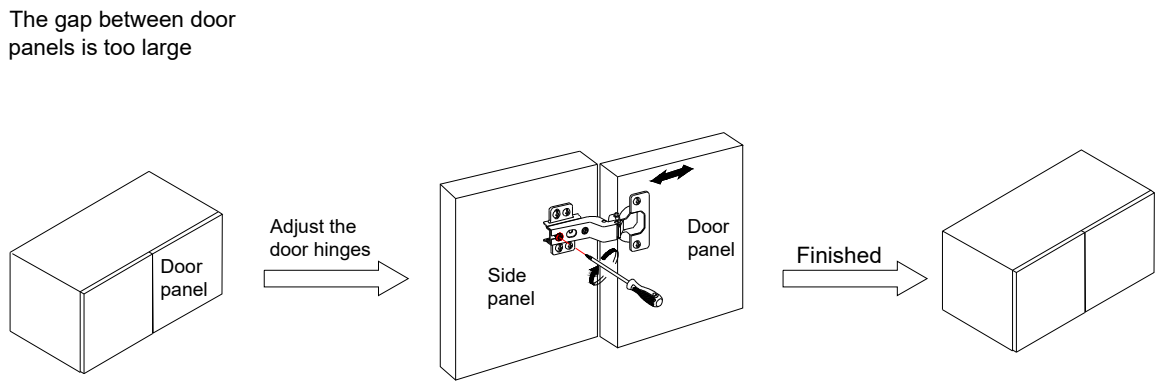
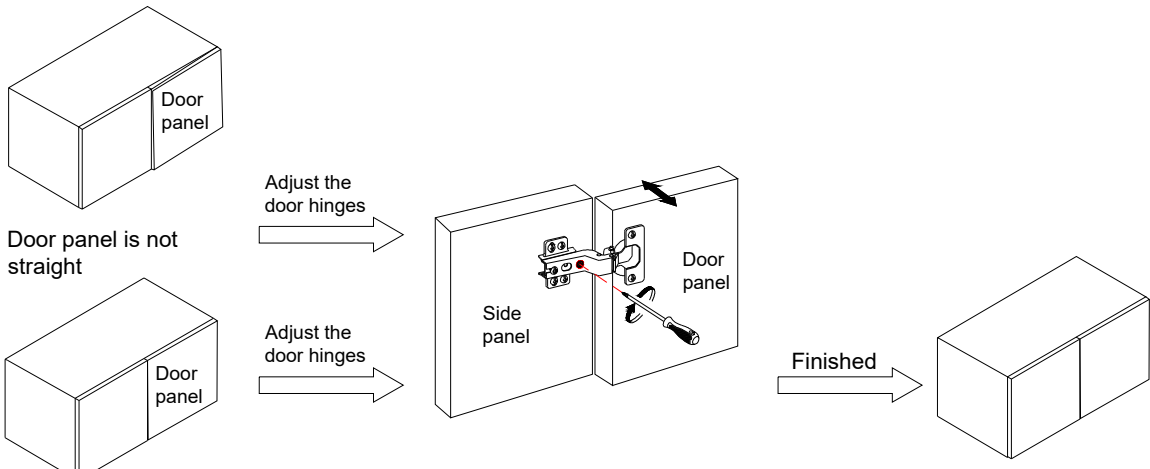

# ASSEMBLY INSTRUCTIONS

11

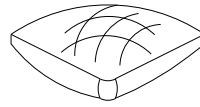

⑫ 1set

A

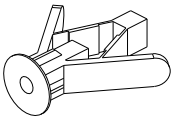

1pcs

B

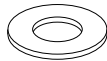

2pcs

C

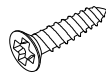

Ø8\*3/4"  
1pcs

D

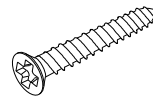

Ø8\*1-1/2"  
1pcs

E

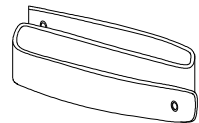

1pcs

