

INTELLIGENT TOILET

EPLO®

Product Manual



Contact TECH Support
support@eplo.com

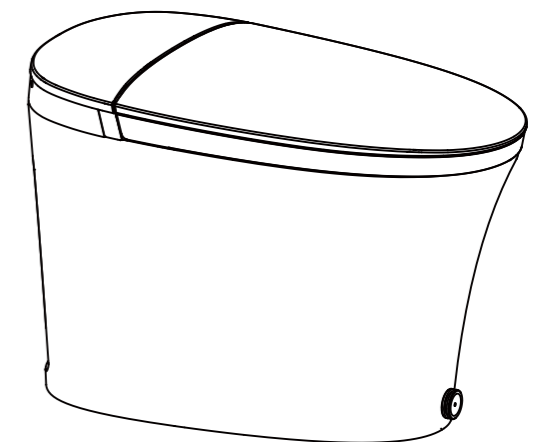

Product Name: Intelligent Toilet

■ Model: iX7
EQ7

Customer Service Email : support@eplo.com

Thank you for purchasing our product. Please read this manual before installation and use to ensure that your product will function at peak performance.

Read this manual thoroughly and store in a safe place for future references.

IMPORTANT SAFEGUARDS

When using electrical products, especially when children are present, basic safety precautions should always be followed, including the following:
READ ALL INSTRUCTIONS BEFORE USING

DANGER – To reduce the risk of electrocution:

1. Do not use while bathing.
2. Do not place or store product where it can fall or be pulled into a tub or sink.
3. Do not place in or drop into water or other liquid.
4. Do not reach for a product that has fallen into water. Unplug immediately.

WARNING – To reduce the risk of burns, electrocution, fire, or injury to persons.

1. Close supervision is necessary when this product is used by, on, or near children or invalids.
2. Use this product only for its intended use as described in this manual. Do not use attachments not recommended by the manufacturer.
3. Never operate this product if it has a damaged cord or plug, if it is not working properly, if it has been dropped or damaged, or dropped into water. Return the product to a service center for examination and repair.
4. Keep the cord away from heated surfaces.
5. Never block the air openings of the product or place it on a soft surface, such as a bed or couch, where the air openings may be blocked. Keep the air openings free of lint, hair, and the like.
6. Never use while sleeping or drowsy.
7. Never drop or insert any object into any opening or hose.
8. Do not use outdoors or operate where aerosol (spray) products are being used or where oxygen is being administered.
9. Connect this product to a properly grounded outlet only. See Grounding Instructions.
10. Do not use while bathing.
11. Risk of Electric Shock. Connect Only to a Grounding Type Receptacle Protected by a Ground-Fault Circuit-Interrupter (GFCI)
12. Risque de choc électrique. Connecter uniquement à un réceptacle du Type de mise à la terre protégé par un circuit de failles au sol (GFCI).
13. CAUTION - Risk of electric shock, do not remove cover (or back). Refer servicing to qualified service personnel.
14. Attention - risque de choc électrique, n'enlevez pas le couvercle (ou le dos). Référez le service à un service qualifié Personnel.

SAVE THESE INSTRUCTIONS

GROUNDING INSTRUCTIONS

This product should be grounded. In the event of an electrical short circuit, grounding reduces the risk of electric shock by providing an escape wire for the electric current. This product is equipped with a cord having a grounding wire with a grounding plug. The plug must be plugged into an outlet that is properly installed and grounded.

DANGER – Improper use of the grounding plug can result in a risk of electric shock.

If repair or replacement of the cord or plug is necessary, do not connect the grounding wire to either flat blade terminal. The wire with insulation having an outer surface that is green with or without yellow stripes is the grounding wire.

Check with a qualified electrician or serviceman if the grounding instructions are not completely understood, or if in doubt as to whether the product is properly grounded.

The functions may vary from different part no.

Category	Functions	Model	iX7/EQ7
Cleaning	Unlimited wash		●
	Rear wash		●
	Front wash		●
	Aerated wash		●
	Auto wash		●
	Oscillating wash		●
	H/C massage		●
	Adjustable water pressure		●
	Adjustable water temperature		●
	Adjustable nozzle position		●
	Detachable nozzle		●
	Nozzle self-cleaning		●
Convenience	Cleaning nozzle		●
	Heated seat		●
	Auto deodorization		—
	Warm dryer plus		●
	Adjustable air speed		●
	Soft close		●
	Adjustable seat temperature		●
	Adjustable air temperature		●
	Night light		●
	Instant heating		●
	Auto flush		●
	Drying with flush		—
	Emergency flush		●
	Remote flush		●
	Kick flush		●
	Auto open lid		●
	Remote open lid		●
	Remote open seat		●
	Kick open lid		●
	Kick open seat		●
	Seat sensor		●
	Digital display		●
	Microwave induction		●
Power Saving ECO		●	
Foam Shield		●	
Silent mode		●	
Safety	Pre-wetting		●
	Memory mode		●
	Auto-start		●
	SUS filter		●
	Air isolation		●
	UV sterilization		—
	Backflow prevention		●
	Easy clean glaze		●
	Multi-Protections		●
	Anti-bacterial seat		●
	Fire and heat resistant		●
Factory reset		●	

Note: ● represents that the product has this function. — represents that the product does not have this function.

User Friendly Design

new features to offer you an enjoyable experience

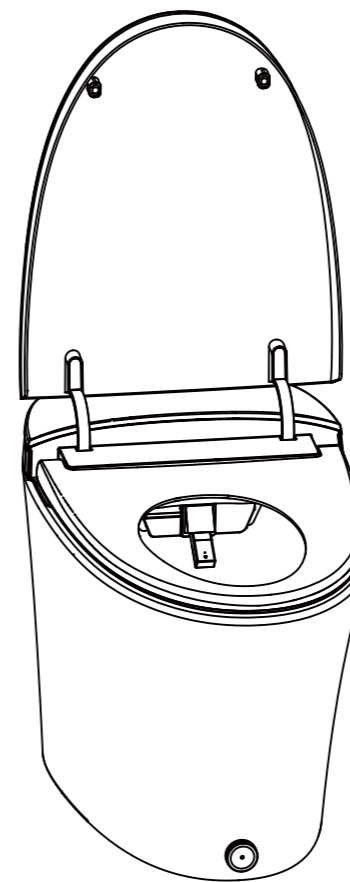

Contents

Parts information	1
Overview	1
Side Buttons	1
Remote Control	2
Warnings and safety	3
Warning	4
Attention	6

Installation	7
Before you Install	8
Installing your product	9
Function explanations	13
Maintenance	17
Surface cleaning	17
Nozzle maintenance	18

Troubleshooting	19
Power button	19
Wash functions	19
Dryer	20
Heated seat	20
Remote control	20
Toilet unit	20
Soft-Closing feature	20
Specifications	21

Before use

Functions

Troubleshooting

Parts Information

Overview, Side Buttons, Remote Control

Overview

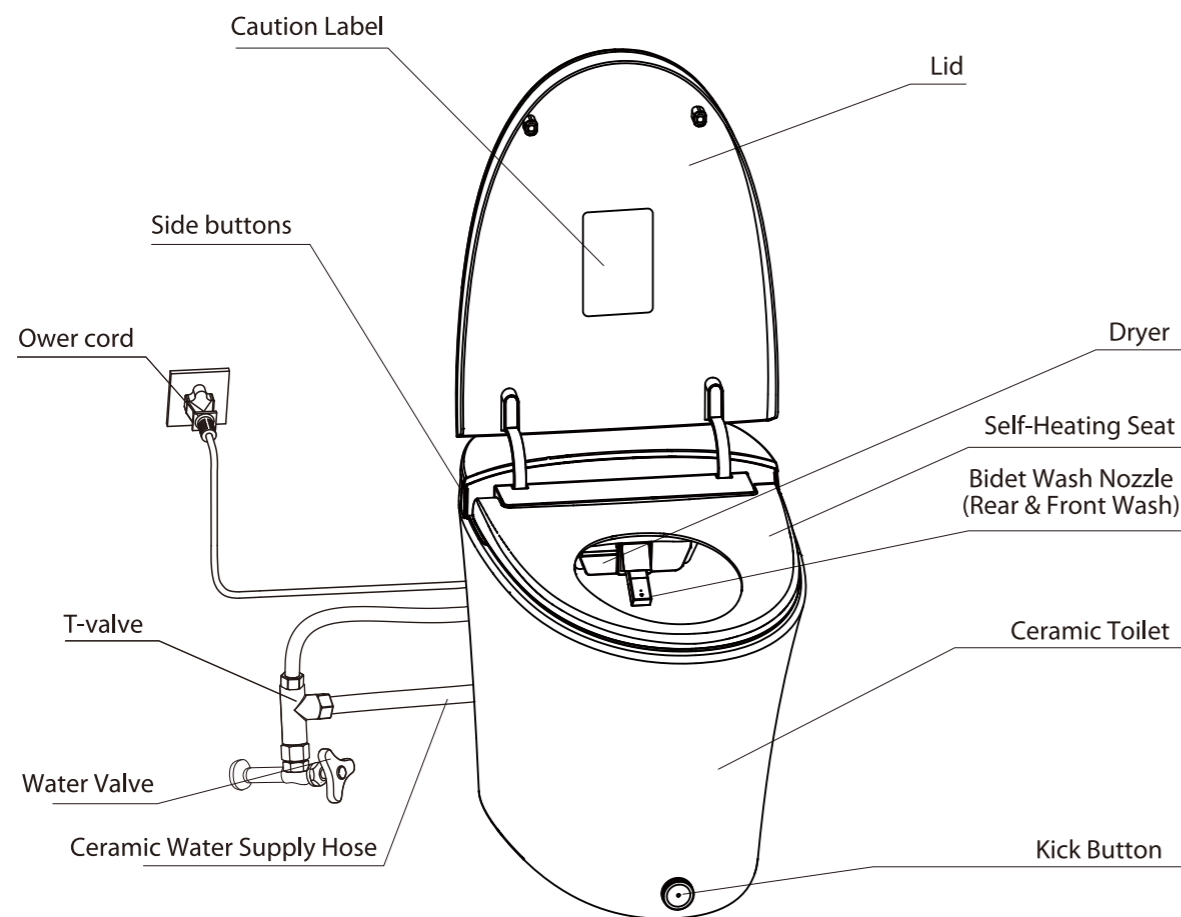

Side Buttons

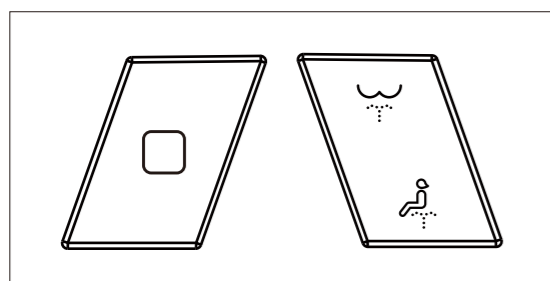

Remote Control

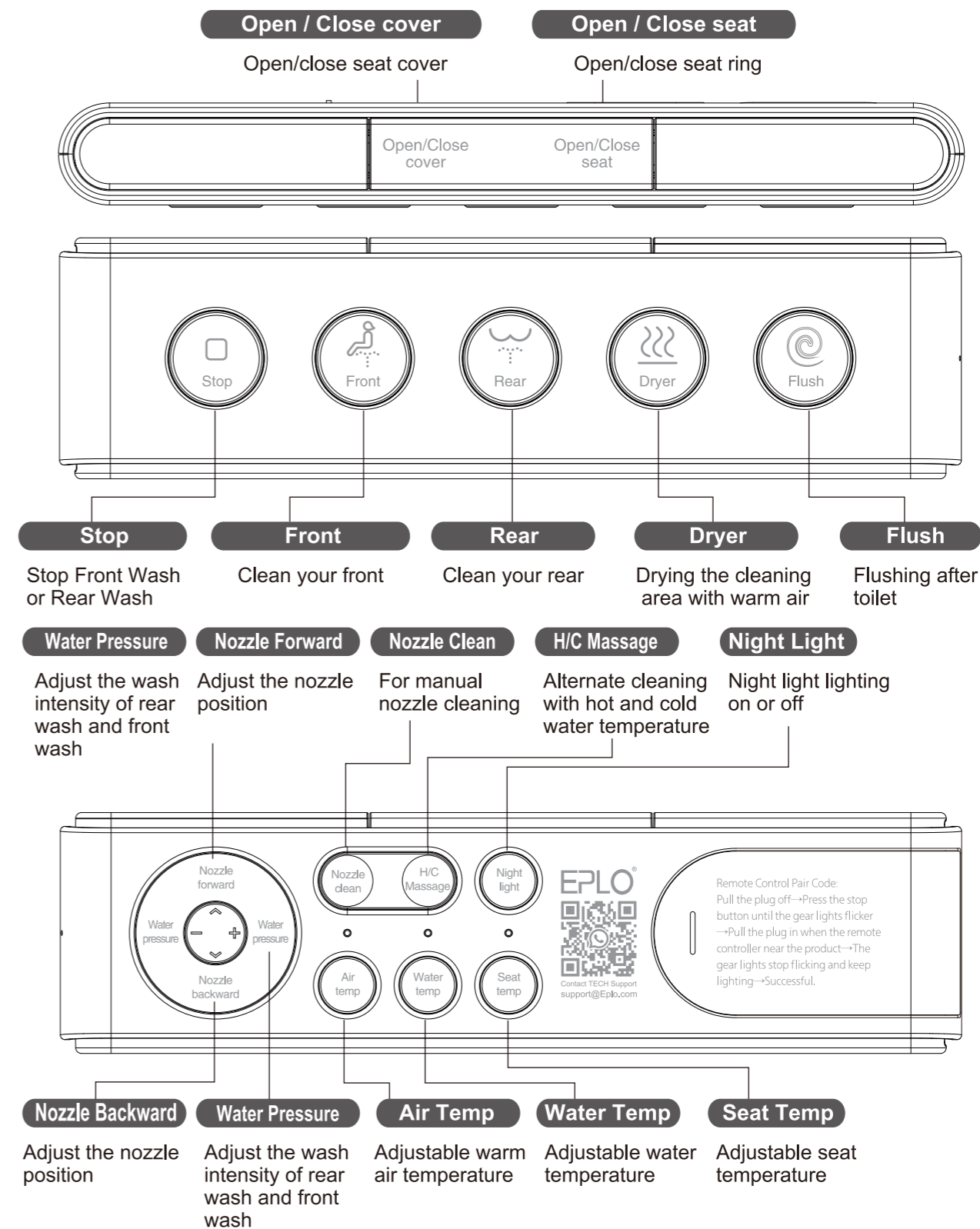

TIPS:

1. Long press "H/C Massage" to turn on/off all Function Prompt Tones (except Alert Tone)
2. Long press the "Night Light" button to turn on/off the power saving ECO function.
3. Long press the "Flush" button to turn on/off the auto flush function.
4. When needs to turn on/ off the automatic open&close lid function, please press "Nozzle Clean+H/C Massage" button on the remote control.
5. Long press the "Seat temp" button to turn on the foam shield function.
6. Long press the "Water temp" and "Seat temp" buttons at the same time to turn on/off the automatic foaming function.

Warnings and Safety

Please read thoroughly

First of all, thank you for purchasing our product. To ensure proper and safe use of this product, carefully read this section prior to any usage. Afterwards, store this manual in a safe place for any needed future reference.

The hazards and warnings listed herein are important to our user's safety. Significant consequences may result from failure to heed warnings. The company will not be held liable for any injuries to the user and damages to the product due to improper usage and/or failure to heed safety warnings.

Explanation of Terms and Symbols

Warning . . . 「Indicates possible injury resulting from improper usage due to negligence of this sign.」

Attention . . . 「Indicates human injury or property loss that may result in improper usage due to negligence of this sign.」

 「Note」 When used with the above "Warning" and "Attention" signs, indicates a strict request to follow noted precautions.

 「Prohibits any individual from performing any action with this symbol.」

 「Prohibits any individual from dismantling product.」

 「Keep product away from any wet environments, including, but is not limited to, humid environments, close proximities to baths, showers or sinks.」

 「Do not touch!」

 「Do not touch with a wet hand!」

 「Keep away from any extreme heat or fire!」

 「Operate only as instructed!」

 「Pull out the power plug!」

 「Protective grounding」

Warning

This product needs to be properly grounded.

- ※Risk of electric shock
- ※If unsure, contact an electrician, electrical installation company.



Do not place a lit cigarette along with other burning objects into the unit.

- ※Risk of fire.



Do not touch, insert or pull out the power plug with a wet hand.

- ※Risk of electric shock.



Do not use during thunderstorms (pull out the power plug during storms).

- ※Failure in doing so may lead to injury or fault in the product.



Do not use a power socket in poor condition or a damaged power plug.

- ※Risk of fire and/or electric shock.

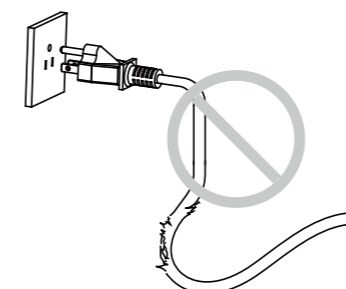

When the seat ring or the cover plate is damaged, to avoid any harm, be sure to pull off the power plug, close the water source and contact your local distributor for replacement.

- ※Risk of fire or electric shock.



Regularly pull out the power plug and wipe off any dust on the power plug using a clean dry cloth.

- ※Risk of fire.



The power socket in use should be within the specified range (AC120V).

- ※Risk of fire and/or electric shock.

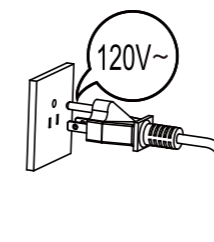

Any person with a disability, the elderly, and children, should be using this product with the supervision of another individual.

- ※Be advised that sitting on the heated seat for an extended amount of time may result in burns.



Do not pull, damage, bend, twist, stretch, roll, bundle, clamp or squeeze the power cable. Do not place anything on power cable.

- ※Risk of fire and/or electric shock



This product is not a toy. Advise children not to play with product.

- ※Risk of injury.



If the power cord is damaged, to prevent any injuries or accidents, it should be replaced by a professional.

- ※Risk of fire and/or electric shock



Do not dismantle, repair or alter this product on your own. Call in a professional.

- ※Risk of fire, electric shock, and/or other accident that may lead to injury.



Warning

For cleaning or maintenance of plastic parts, do not use any harsh cleaning agents. (These include, but are not limited to products such as: concentrated sulfuric acid, concentrated nitric acid, glacial acetic acid, carbon tetrachloride, chloroform, acetone, butanone, benzene, methylbenzene, phenol, methylphenol, dimethylformamide, methyl ether, soybean oil, acetate, 40% nitric acid, thick salt acid, 95% alcohol, gasoline, kerosene or brake oil, etc).
 ※Risk of damaging parts that can lead to accidents and injuries



Do not use polluted water or water meant for industrial.
 ※Risk of urocystitis or dermatitis.
 Untreated water may also cause corrode inner workings of unit and may cause electrical shock or a fire.

Do not apply any force to the unit's seat and lid. Do not stand on the lid or open or close the lid and the seat forcefully.

※This may result in product damage and/or user injury.



Do not add water or detergent into the unit or on to the wireless remote. Do not soak the product with water or cleaner.

※Risk of fire and/or electric shock.

Do not install product in a humid environment or a soak room. Do not spray or soak this product with any form of liquid to prevent any damage to the product.

※Risk of fire and/or electric shock.



Do not place your hand or any other object into the dryer trap, and do not cover the dryer and dryer trap during product use.

※Risk of fire, electric shock, and/or other accident that may lead to user injury.

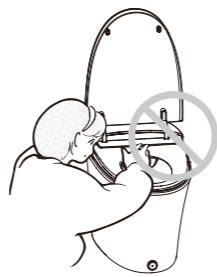

Do not spray urine at the dryer trap.

※Risk of electric shock.

Read the following for proper battery usage.

- Properly install the battery according to its correct polarity.
 - Remove the battery during long periods without use.
 - Replace the battery before it reaches the end of its usage. Failure to do so may result in interrupted control signals.
 - Cover the battery with tape before disposal.
- ※This will prevent battery fluid leaks that may cause fire and/or other damages.

Warning

- Place the battery out of children and infant reach.
- ※If battery is swallowed, contact a doctor immediately.
- If battery fluid leaks onto user, quickly rinse off area using water.
- If battery fluid gets into eyes, do not rub your eyes. Quickly rinse it with water and consult a doctor immediately.
- ※May result in vision impairment or blindness.

When the battery is in use, do not do the following operations.

- Do not hold or store with metal objects (such as a necklace or a watch).
- Do not mix new and old batteries.
- Do not pull battery apart battery or throw it into water and/or fire. Battery fluids may cause a fire.

Attention

Do not use the heated seat or warm dryer temperature for an extended amount of time.
 ※Extended use may result in burns.

Avoid direct sunlight or heat.
 ※Risk of product discoloration.

While using this product, make sure that the skin is in contact with the seat sensor area. Otherwise, product may not operate correctly.
 ※Children and smaller individuals may have trouble staying in contact with sensor area.

Do not supply electricity with an external switch. I.e: connecting the universal part to a timer switch.
 ※Run the risk of issues caused by improperly resetting the thermal breaker.

Do not spray urine in the direction of the bidet nozzle.
 ※Doing so may result in blockage to the bidet nozzles and cleaning area.

When the filter is being replaced, be sure to close the water supply angle valve. When the filter is being installed, be sure to fasten it with force.
 ※Risk of water leak

Do not use your old hose component. Use the one provided with your product. Anything else connected to the older hose may need to be replaced.
 ※Risk of water leakage and/or property loss/damage.

Pull out the power plug when the product is in disuse for an extended amount of time. Make sure to shut off the water and remove the water inside the product.
 ※Risk of fire, leaks, and product damage.

In case of sudden power failure, remove the power plug and close the angle valve to prevent water leakage.
 ※Risk of water leakage and/or property loss/damage.

When storing or transporting in cold climate, make sure to remove all water from the unit. Product may crack and other damages may occur due to freezing water.
 ※Risk of fire, leaks, and product damage.

Installation

Tools required for installation

Required tools

Required tools for installation. Please have these tools prepared prior to installation.



Drill
(Dia. 0.24in)

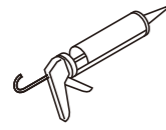

Silicone gun



Teflon tape

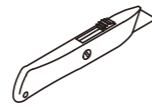

Knife



Marking pen



0.91 - 0.98 in
(Spanner model varies for different pipes)

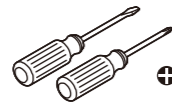

± screw driver







Measuring tape

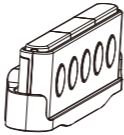
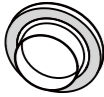
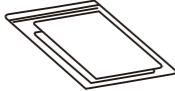

Measuring cup

Item list (Confirm that all below items are inside the box)

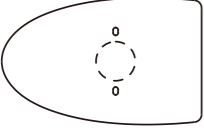
Intelligent toilet(1 set) 	T-valve(1 pcs) 	Two AAA Battery 	Remote control set(1 set)  (holder 1 pc, screw 2 pcs)
Wax Ring(1 pcs) 	Installation Book & User Manual 	Sealing Flange 	Mounting accessory kit(2 pcs) 
Mounting Template 			

※Please confirm all the aforementioned items are inside the package.
If there are any omissions, please contact our customer service.

Before you Install

Water pressure check, dimensional drawing

Confirmation of water pressure

- The minimum dynamic operating water pressure is 35 psi, and the maximum static water pressure is 108 psi.

Determination method for minimum water flow

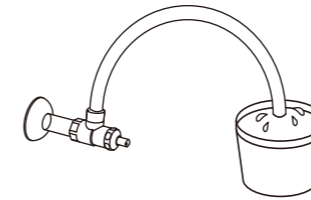

Open the angle valve for water supply. Ensuring a flow of water at least 10.57 gal/min.

※If the above conditions cannot be met, the best flushing effect cannot be achieved and an additional booster pump is required to increase the pressure.

(Tools: stopwatch, measuring cup.)

Confirm dimensions of product with installation space

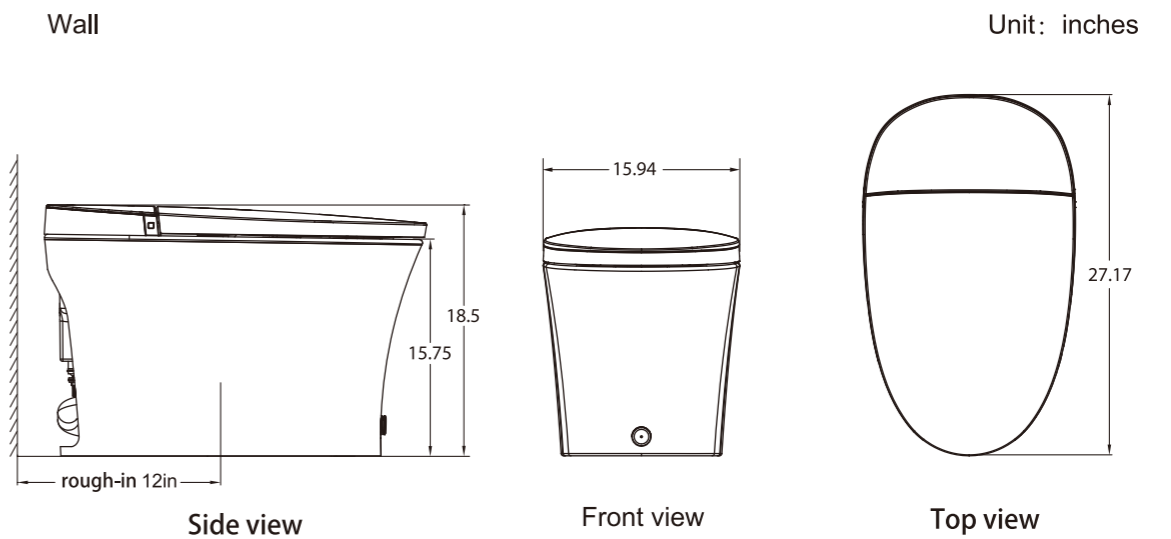

Installing your product

Install your unit using the following steps

1 Open the box right side up

Remove the accessories first, then remove the unit from the top, as shown in the diagrams below.

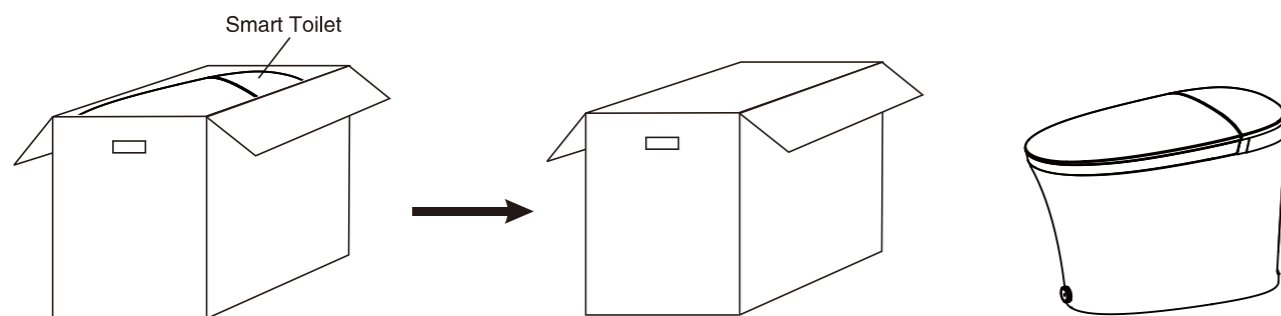

2 Mark your drainage hole with a cross

Cardboard installation

- Align cardboard with the centerline of drain outlet;
- Draw contour line according to cardboard;

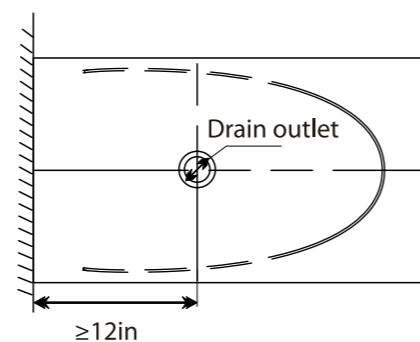

3 Mounting bracket installation

- Assemble the mounting bracket with bolts and then install them to the pre-installed flange plate on the ground and lock tight with nuts.

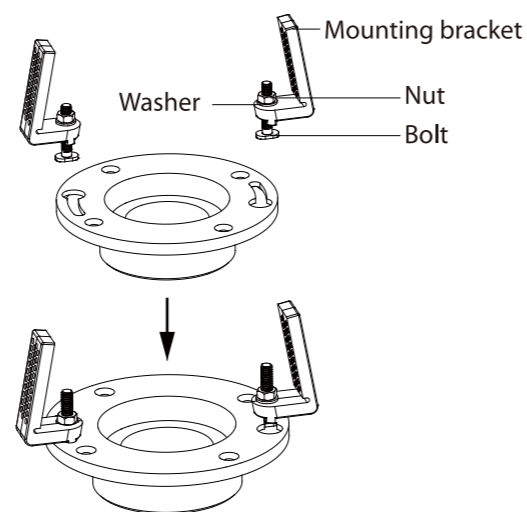

4 Install the ceramic body, water supply hose, T-valve

1. Place the wax ring on the drain hole at the bottom of the ceramic.

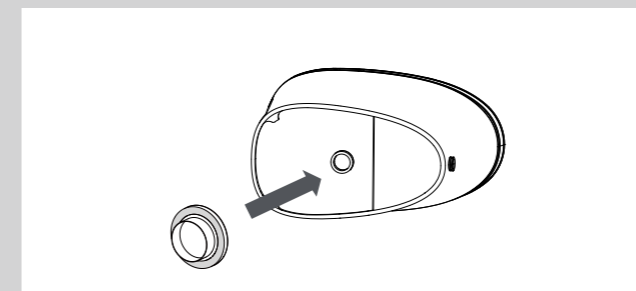

2. Install sealing flange into drain outlet.
3. Install ceramic toilet on corresponding position according to contour line.

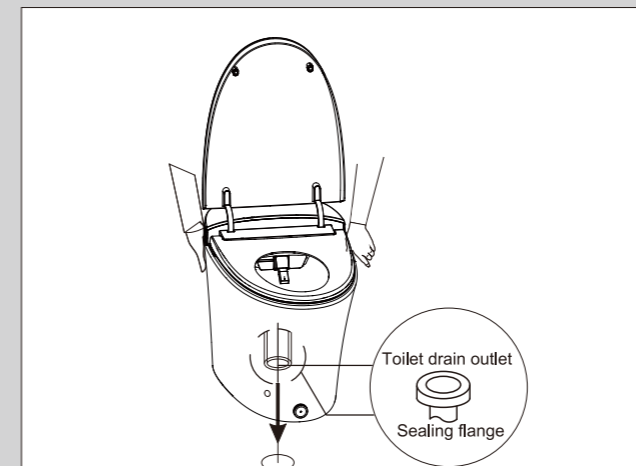

4. Put the screw through the fixing sleeve and then install it through the holes (on both sides of the toilet ceramic) to the mounting bracket on the ground, and lock tight with a tool.
5. Put the decorative cap on the fixing sleeve.

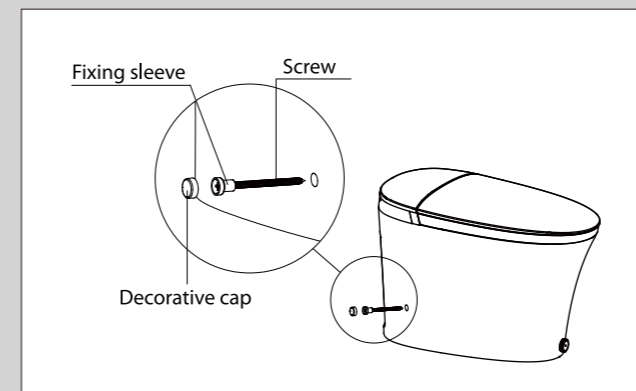

6. Attach the flush water hose to the T-valve and tighten.

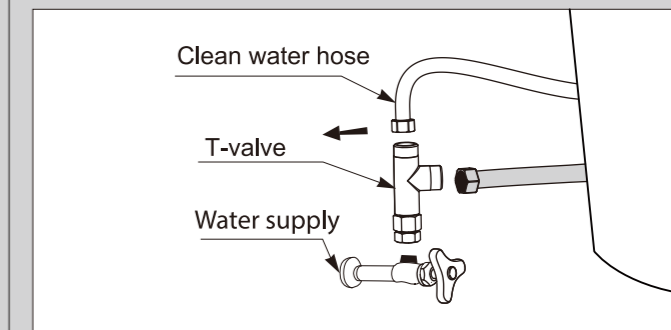

7. Attach the clean water hose to the T-valve and tighten.

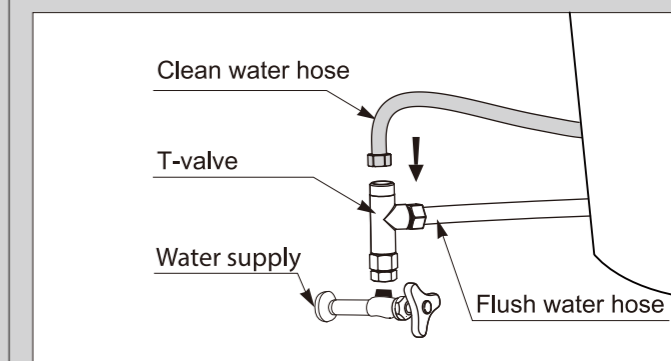

8. Connect the T-valve to the water supply and tighten. Use gasket to prevent water leakage.

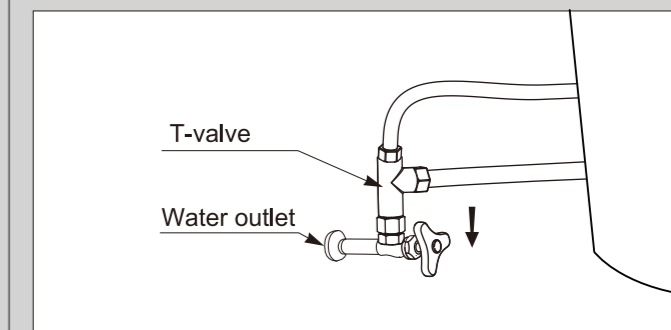

9. Finish installation.

5 Installing the remote

1. Drill two 6mm(0.24 inch) diameter holes on the wall (about 1.77 in deep)
2. Knock the anchors into the hole with a hammer.
3. Secure the holder with anchors.
4. Use the screws to secure the holder to the wall.
5. Remove the battery cover from the backside of the remote to install batteries
6. Once finished, remote is ready to be placed in its holder.

Detailed steps shown in the diagram below:

- ※ Please use proper mounting tools for special wall surfaces (such as wood, HDF, etc.)
- ※ The remote control holder should be installed away from the bidet's spray trajectory.
- ※ The remote control holder should be installed within reach when seated on unit.
- ※ Make sure there is nothing to block the transmission between the toilet and its remote.

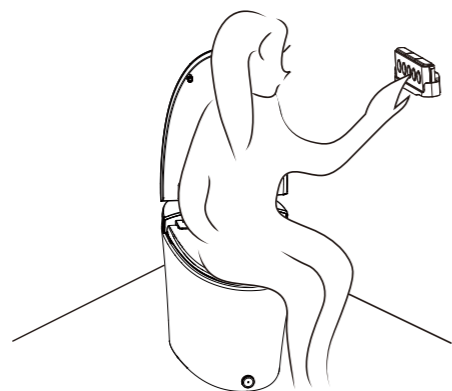

Steps:

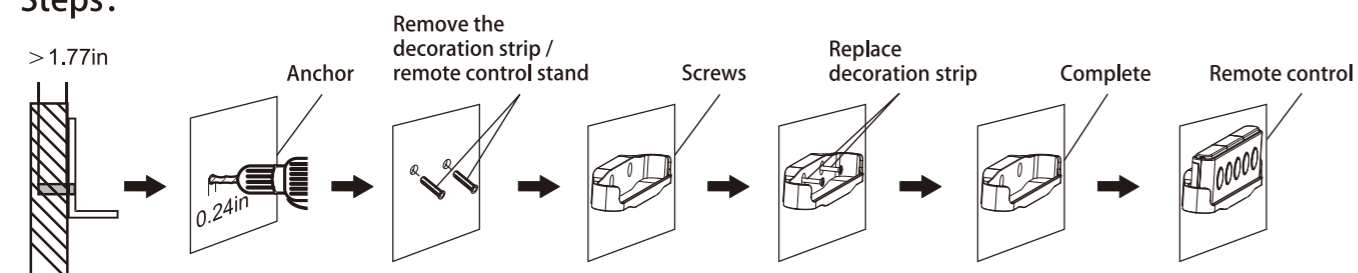

6 Installing and replacing the battery box

Install and replace the emergency flushing battery

1. Reach into the bottom of the toilet cover and lift the cover upward firmly;
2. Remove the battery cover by unscrewing the screw with a crosshead screwdriver;
3. Replace the new battery, shut the battery cover, and tighten the screw with a crosshead screwdriver;
4. Place the toilet cover to the flat position and press down to fix the cover.

※ Please confirm the battery's positive and negative poles. Please do not charge, disassemble, fire the battery, or mix with used batteries or different kinds of batteries to avoid liquid leakage or explosion.

※ The battery box has a moisture-proof function. Please ensure that the set screws are screwed in place to achieve a good seal effect.

※ If the battery needs to be replaced, it is recommended to contact your local dealer to have it replaced by specialized personnel.

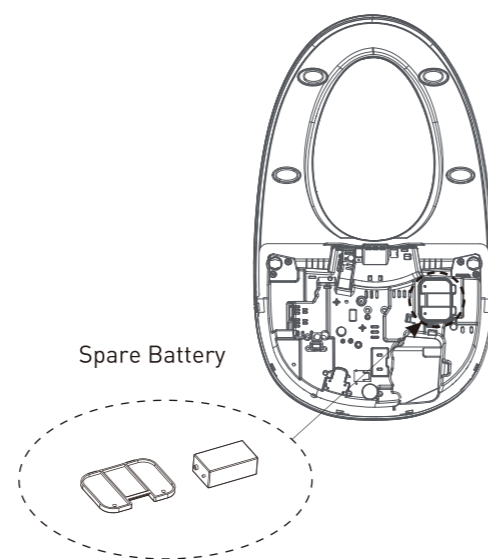

7 Testing water flow

1. Open the water supply angle valve to maximum as shown in the figure.

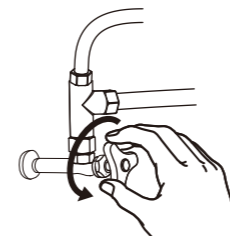

2. Confirm various connecting parts are not water leaking.
 - ※ In case of water leaking, unfasten the nuts again and install them again.

8 Connecting power

1. Connect to the grounding.
2. Plug in AC 120V power plug.

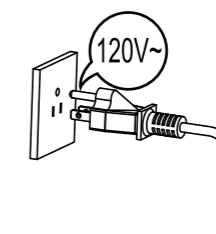

3. Check to see if the power is on.

- (1) Check to see if the power light is on.
- (2) Press the side button to confirm that the toilet is powered on.

Testing the product

(Test whether the functions of the buttons on the remote control and the button on the side of the body are normal)

- Are all the functions working properly?

Rear Wash, Front Wash (Including water pressure & nozzle position adjustment), Heated Dryer, Water & Seat temperature Adjustment, Nozzle cleaning, Remote control. All functions listed above should be tested.

- Checking Rear Wash

Please use your hand to hold the seat sensor area, press the side " " button or press the "Rear" button on the remote control, and use your hand to cover the front of the washer to block the flow of wash water to avoid spraying water on your body or clothing.

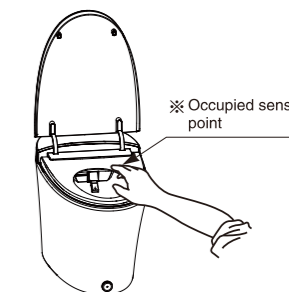

Matching your remote control code

※ When the product leaves the factory, the remote control and the product are connected, if the remote control went failure, please re-connect the code as following methods.

1. Unplug the product's plug, press the stop key for few seconds until the level light is flickered.

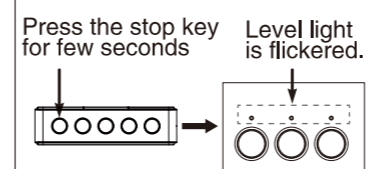

2. Plug the attaching plug when the remote control get closer to the product.

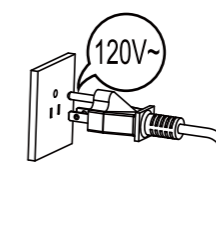

3. The level light stops flickering, and then it is lighted on.

All the level light (red) is lighted on

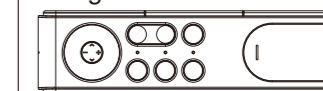

4. At the time, the remote control and product is re-connected.

《Function Explanations》

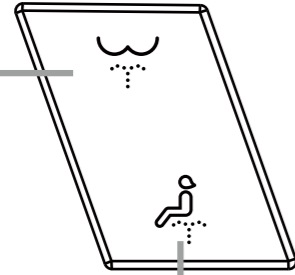

■ Front Wash

Under no cleaning and drying mode, and seating the toilet.

Short press the button to enter into the front wash mode, which the mode is defaulted to cleaning moving. The cycle of operation: front wash 1.5mins + drying 4mins. When the front wash is in the cleaning state, you can short press the button again to directly enter the drying mode.

■ Rear Wash

Under no cleaning and drying mode, and seating the toilet.

Short press the button to enter into the rear wash mode, which the mode is defaulted to cleaning moving. The cycle of operation: rear wash 1.5mins + drying 4mins. When the rear wash is in the cleaning state, you can short press the button again to directly enter the drying mode.

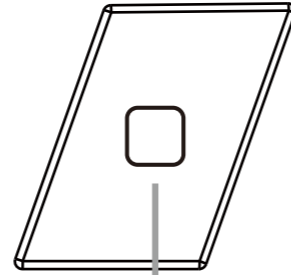

■ Power/Stop

Standby mode: Press and hold the button for 3 seconds to activate it.

Activated and not seated: Press and hold the button for 3 seconds to enter the standby mode.
Activated and seated: under the rear washing, front washing, drying mode, press it for short time to stop it.

■ Flush

Powered on with no functions running.

Press it for short time to flush

■ Emergency flush

When the product is not powered-on, short press the "□" button or tap the "Kick Button", it can achieve emergency flushing function.

※If the above operation does not work, you need to replace the battery or contact us local dealer.

■ Auto flush

When the seat sensor no longer detects a user, it will automatically flush.

The toilet will only flush once.

■ Dryer

Dries both front and rear areas.

Press the 'Dryer' button once.

Press the 'Dryer' button again to adjust the wind speed, which can be set to three levels from low to high.

■ Kick flush

Touch "Kick Button" gently.

Tap the foot kick can realize the flushing function.

■ Kick to open lid / seat

Tap the "Kick Button" with your foot to raise your toilet lid / seat.

Tap the kick button once: Lid opens.

Tap the kick button twice: Seat raises.

Tap the kick button three times: Seat and lid will close and toilet will flush.

※Please do not touch the button forcefully.

※Rear / front wash is not available during flushing.

■ Night light

Automatic operation according to ambient light.

When the night light is turned on, the night light can be turned on / off automatically through the change of external light intensity. When there is strong light, the night light will turn off automatically, and when the light is weak, the night light will turn on automatically.

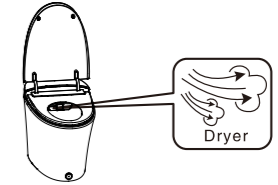

Light sensing device

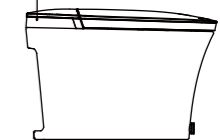

■ Microwave induction

Microwave will detect any user within a 3ft radius.

Lid will open automatically for any user within a 3ft radius. Close automatically when it no longer detects a user.

■ Digital display

When adjusting seat temperature, it will show seat temperature; when adjusting water temperature, it will show water temperature; when adjusting air temperature, it will show air temperature; ECO is shown when the power saving function is activated.

■ Power Saving ECO

Long press the "Night Light" button to turn on/off the power saving ECO function.

When power saving and seat temperature are activated, about 30 minutes after leaving your seat, seat temperature decreases to a low setting and held.

■ Foam Shield

Long press the "Seat temp" button to turn on the foam shield function. Long press the "Water temp" and "Seat temp" buttons at the same time to turn on/off the automatic foaming function.

※ Please kindly noted that you would like to purchase foam liquid to use this function.

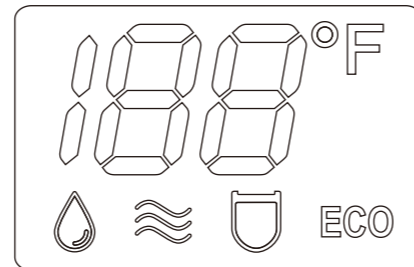

■ User-friendly Design

- Slow-closing lid/seat
Preserve your toilet's life and allows you to close the lid/seat silently.
- Damper
The product has installed the damper which provide the toilet cover and toilet seat with a buffer function, to achieve the mute effect.
- Multi-Protections
Multiple built-in safety features to protect the user and product.
- Memory mode
After power failure, water temp, water pressure, seat temp, and wand position are all restored to mid-range after power failure. On / off, keep the last memorized setting state.
- Self-cleaning Nozzle
The washer can automatically clean, keeping bacteria and stains away.
- Pre-flush
After seating, the product will flush once towards the seat to ensure that the seat wall is moistened.
- Antibacterial Seat
Antibacterial material is used for the seat.

■ Foam liquid filling

1. Push back to remove the decorative cover, then take out the silicone plug of the liquid filling port.
2. Open the cap of the foam liquid bottle, pour the foam liquid through liquid filling port into the product; the amount of liquid added at one time should not exceed 1.2L (the volume of the liquid storage bottle is 1.2L), otherwise it will overflow.
3. Put the silicone plug back into the filling port, align the decorative cover with the buckle, and push it forward into place.
4. After sitting down or long pressing the "Seat temp" button on the remote control, if no foam flows out, it means that the foam liquid has been used up and new foam liquid needs to be filled. The filling method is as above (steps 1-3).

- ※ New factory products need to add foam liquid first.
- ※ Please use customized foam liquid, otherwise it may cause clogging and damage to internal components.
- ※ When you need to replace and purchase new foam liquid, please contact your local dealer.
- ※ When replacing foam fluid or performing maintenance, be careful not to let sediment and other particles into the product.
- ※ When replacing the foam liquid, please unplug the power plug first, add liquid, and then power on again.

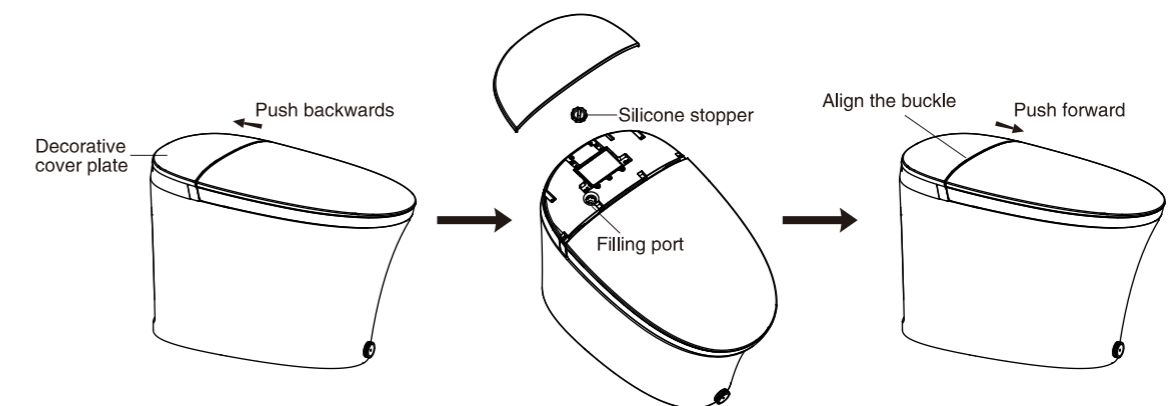

Maintenance

Regular maintenance is required to ensure normal use

Note

- Cut off the power and water supply before maintenance.
- Direct water wash to the entire product is prohibited.

Maintenance of product surface and ceramics

- Wipe dust or stains with a soft wet cloth
- A wet soft brush, cloth or sponge may be used to clean the ceramic area
- ※ Do not use abrasive cleaning solutions, such as alcohol, bleach, paint thinner, cresol, benzene, gasoline, etc.



- Built-in filter needs to be cleaned quarterly.

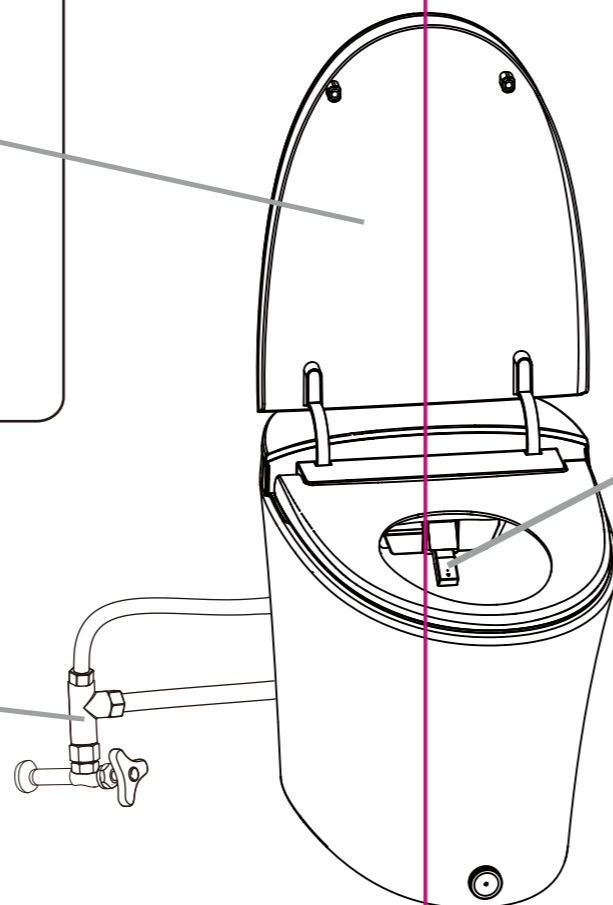

WARNING

Do not spray water or detergents on the toilet, remote control or the power cord. Doing so may cause electric shock or fire.

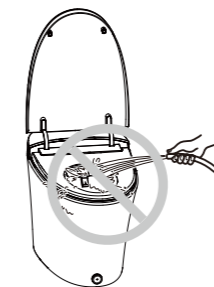

Maintenance during Winter Season

During winter season, the water inside may freeze after long periods of storage and non-usage. Please take measures to prevent.

Note

- Before connecting the product to the water supply and electrical outlet, allow it to defrost for 30 mins in a warm indoor environment.
- In cases of extreme cold/freezing/nozzle stuck in place, wrap the water input line with a warm towel. Never pour hot water or use a hot dryer directly on the toilet.

Maintenance of the nozzle

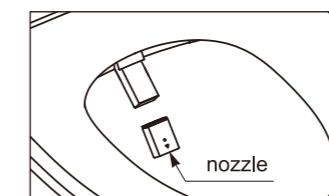

Press the "Nozzle Clean" button on the remote control without occupying the seat. The nozzle will extend. Proceed to clean with a soft toothbrush.

- ※ Do not forcefully hold the nozzle, otherwise it may break.
- ※ Please change the spout if it blocked.

Troubleshooting

Experiencing issues with your product?

If the user should run into any issues, please consult the troubleshooting guide below. If problem persists, please contact a professional.

Power Button

Phenomenon	Fault Diagnoses	Solutions
Not working	Check whether the attaching plug is loose or not	Please check the circuit
	Check whether the power is switching on or off (the power light is not on)	Press “ <input type="checkbox"/> ” button for 3s, the power light is on.

Wash Functions

Phenomenon	Fault Diagnoses	Solutions
No water from the spout	Check whether or not the water supply cuts off	Wait for the water supply restoring
	Check whether or not the angle valve switches off	Open the angle valve
	Check whether or not the water filter is blocked	Clean the filter mesh or change the water filter
	Check whether or not the inlet pipe is flexed	The inlet pipe must be straight
The intensity of cleaning is not strong enough	Check whether or not the water pressure of cleaning switch to low level or not	Regulate the water pressure according to the instruction manual
	Check whether or not the inlet filter is blocked	Clean the filter mesh or change the water filter
Unusual water flow from the spout	Abnormal operation	Unplug the attaching plug for one minute and then plug it again
The water temp is not warm enough	Check whether or not the water supply switches to low level	Regulate the water temp according to the instruction manual
The cleanser is always leaking	Solenoid valve no longer has any effect	Please contact with our qualified maintenance personnel for repairing
The cleaning function is not working normally	The human induction system of the toilet seat no longer has any effect	Please contact with our qualified maintenance personnel for repairing

Dryer

Phenomenon	Fault Diagnoses	Solutions
The dryer blows cold air	Check whether or not the dryer switches off	Regulate the temperature of dryer according to the instruction manual
	Check whether or not the heating element of dryer is damaged	Please contact with our qualified maintenance personnel for repairing

Heated Seat

Phenomenon	Fault Diagnoses	Solutions
The seat temp is too low or is not hot	Check whether or not the temp of toilet seat is on the “off” position	Regulate the temperature of toilet seat according to the instruction manual

Remote Control

Phenomenon	Fault Diagnoses	Solutions
The blue light of water temp is flickered	Low battery	Please replace a new battery
Remote control is not working	Check whether or not there is any water on the remote control	Wipe off water by dry towel

Toilet Unit

Phenomenon	Fault Diagnoses	Solutions
The product is not flushed clean	No power supply	Power restoration
	No water from the spout	Please contact with our qualified maintenance personnel for repairing
	No water but have the sound of flushing	1. Check whether or not the pipeline is blended or not, please keep the water supply pipeline open and smooth 2. Check there is any damage of water pump
	have water all the time	Please contact with our qualified maintenance personnel for repair if there is any unusual from the water inlet valve.

Soft-Closing Feature

Phenomenon	Fault Diagnoses	Solutions
The function of flipping the seat cover / ring up by foot touch cannot open or close	Auto-damping is damaged	1. Recharge after unplug the attaching plug 2. Please contact with our qualified personnel if the following solution is not working

Specifications

Rated voltage		120V~
Frequency		60Hz
Rated power input		1050W(When inlet water temp in 59°F)
Seat and dryer temperature range		4 different levels
Dryer temperature range		95°F–131°F
Water supply hose type		DN15(G1/2")
Water Inlet	Minimum pressure	35psi, ensuring a flow of water at least 10.57gal/min
	Maximum pressure	108psi (static state)
Toilet	Flush type	Tornado flush
	Rough-in	Rough-in 12in
Flushing	Heating type	Instant heating
	Washing temp range	OFF/93.2°F–102.2°F (4 levels)
	Safety system	Butterfly thermostat, thermal fuse, flow sensor
Dryer	Dryer temp range	OFF/ 95°F–131°F (4 levels)
	Dryer air speed	> 4m/s
	Safety system	Thermal fuse, bi-metal
Heated seat	Heat temp range	OFF/ 93.2°F–102.2°F (4 levels)
	Safety system	Thermal fuse
Power cable length		Appx. 35.43 in