

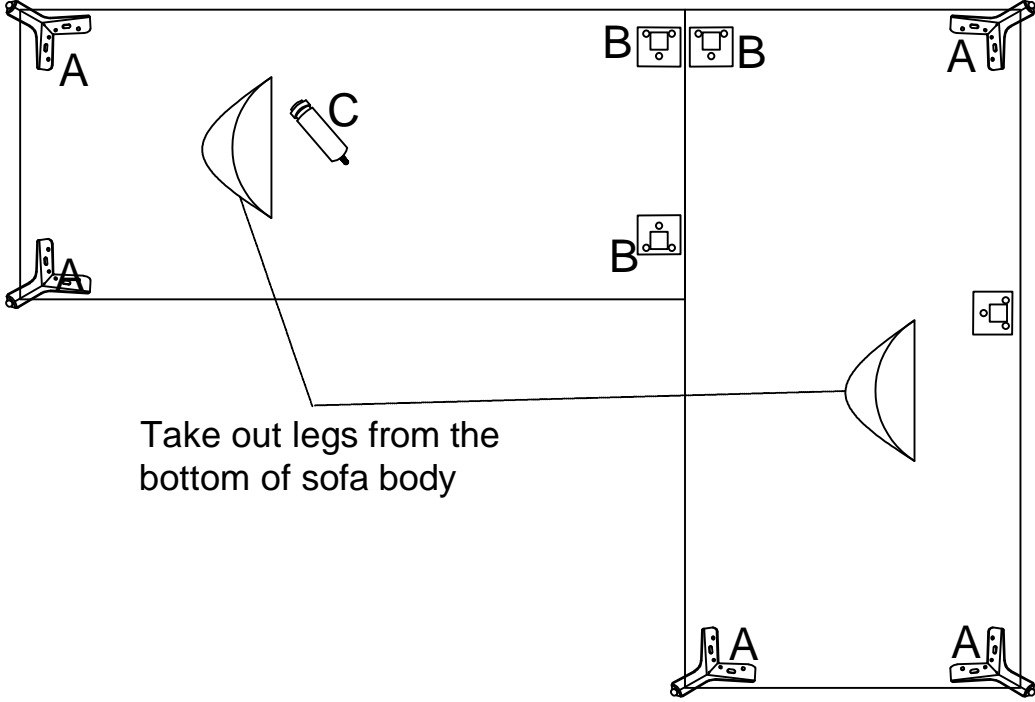

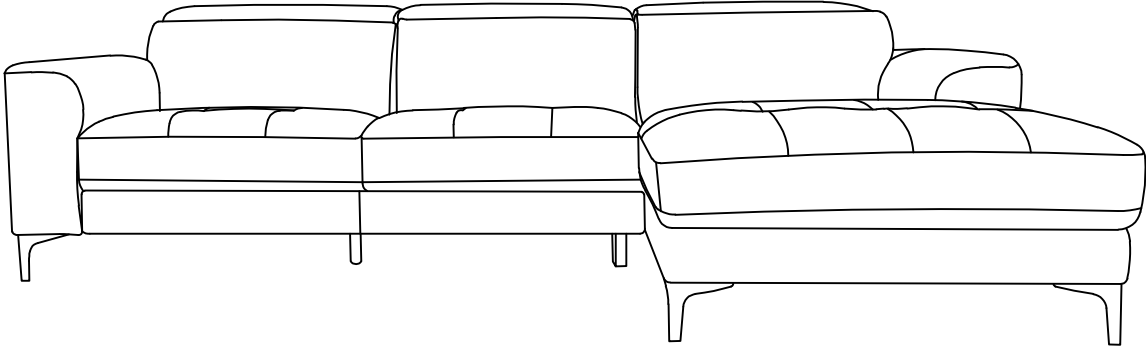





Assembly Instruction



	A	5PCS
	B	4PCS
	C	1PC
	D	22PCS
	E	1PC
	F	1PC
	G	2PCS
	H	3PCS
	I	10PCS
	J	
	K	
	L	
	M	
	N	
	O	

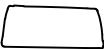
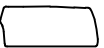
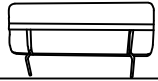

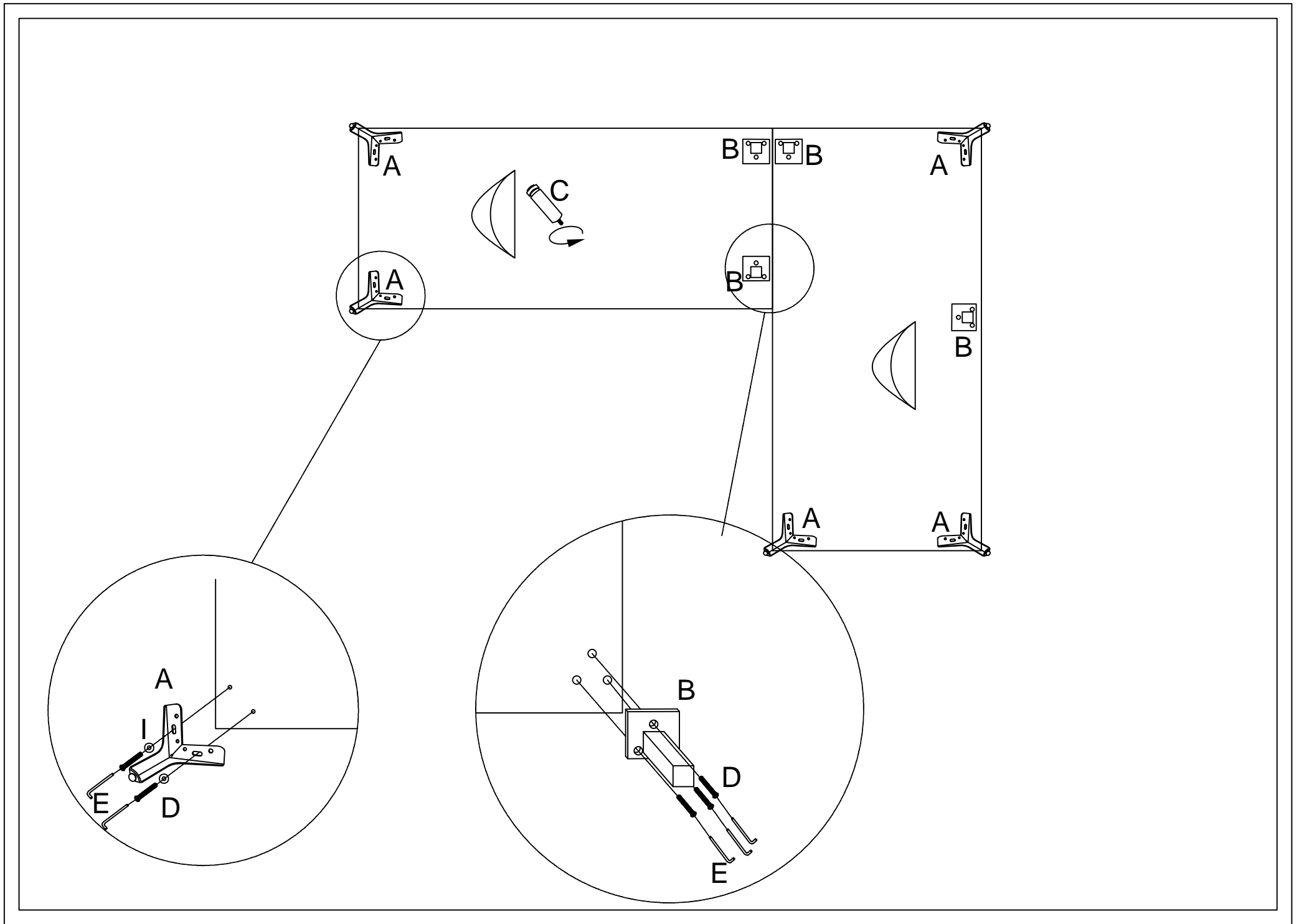
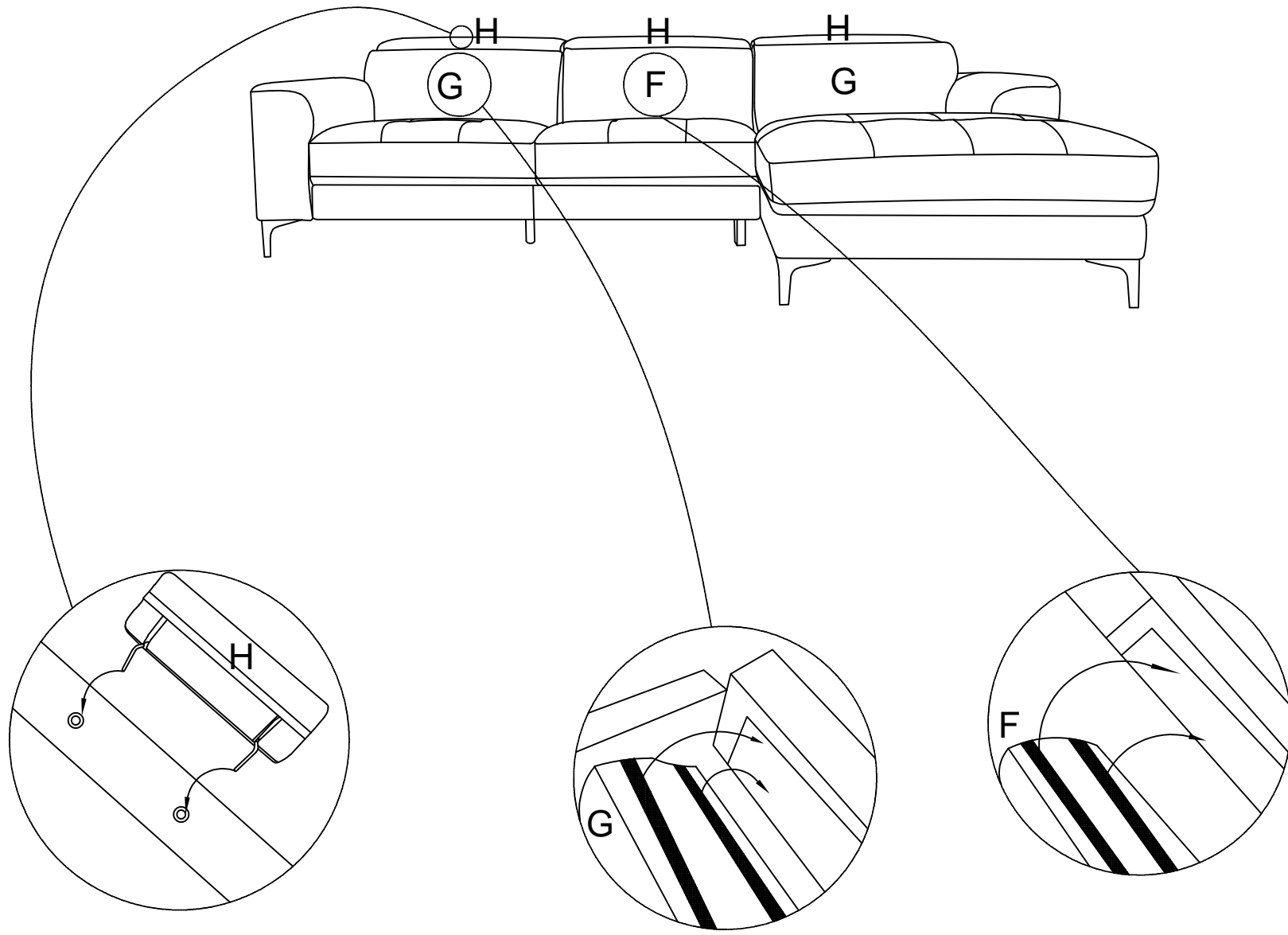

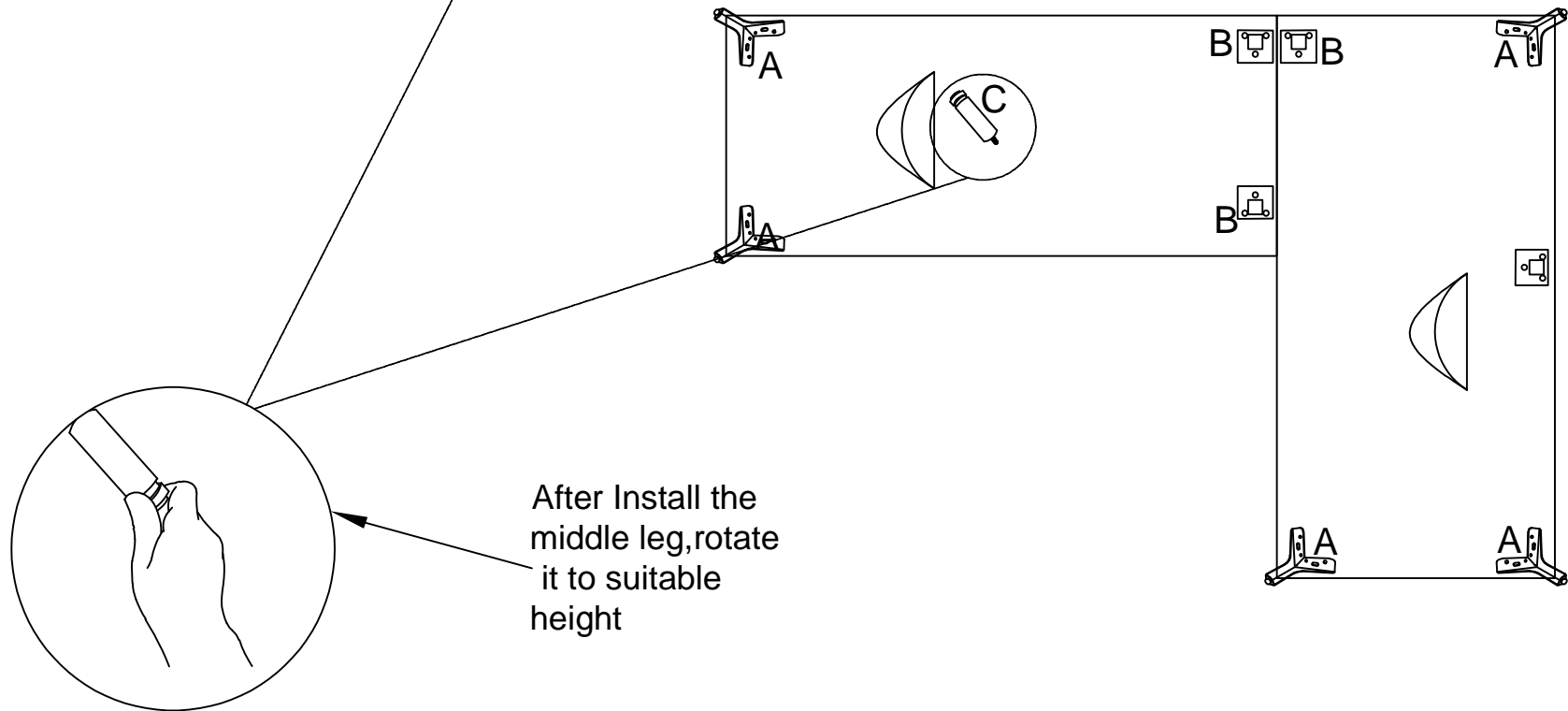
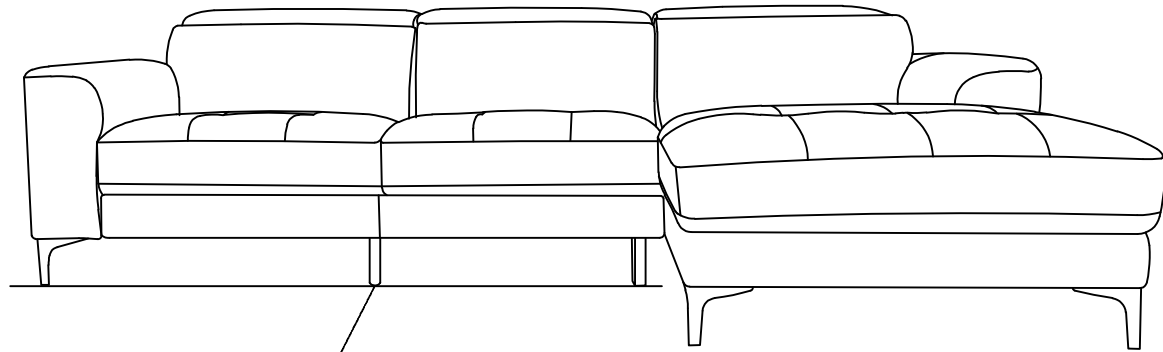

After Install the middle leg, rotate it to suitable height