

Assembly Instructions

Caution : You must read this before you proceed

Push Back Chair

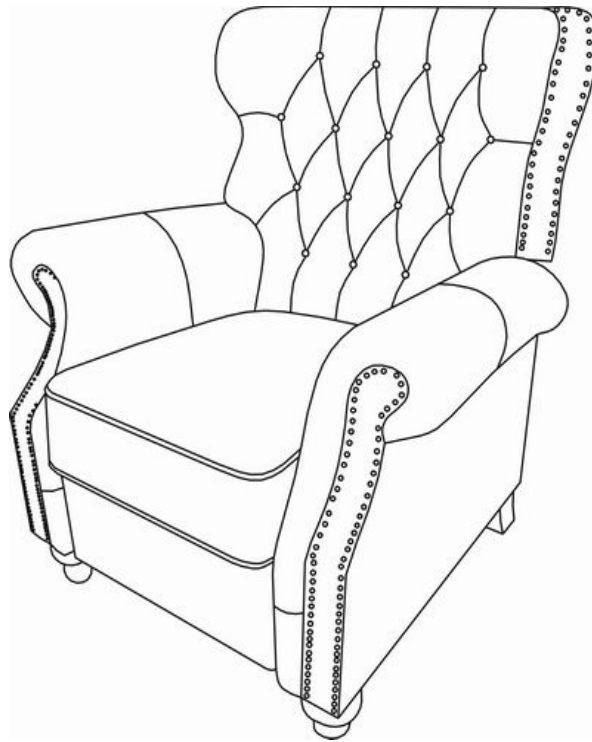

Parts List

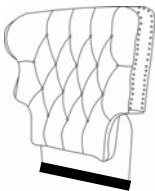
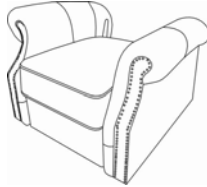
Label	Picture	Description	QTY
A		Chair Backrest	1
B		Chair Base with Footrest	1

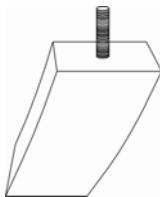
C		Front Leg	2
D		Hind Leg	2

Hardware

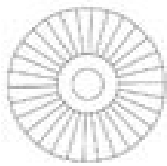
Label	Picture	Description	QTY
①		Gasket	7

Assembly Preparation

Before Beginning Assembly:

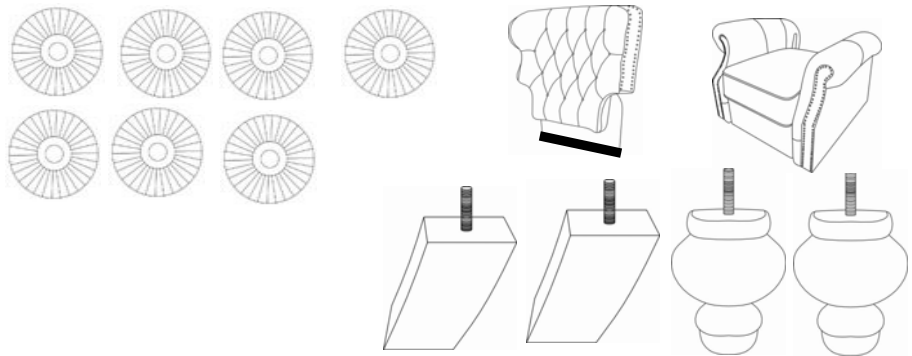

- Read instructions, cover to cover-



- Have 2 adults on hand for assembly-



- Do not assemble on flooring or carpet-



- Assemble on a clean non-marring surface (packing foam)-



- Save all packaging until finished-

Assembly Steps

Parts Introduction

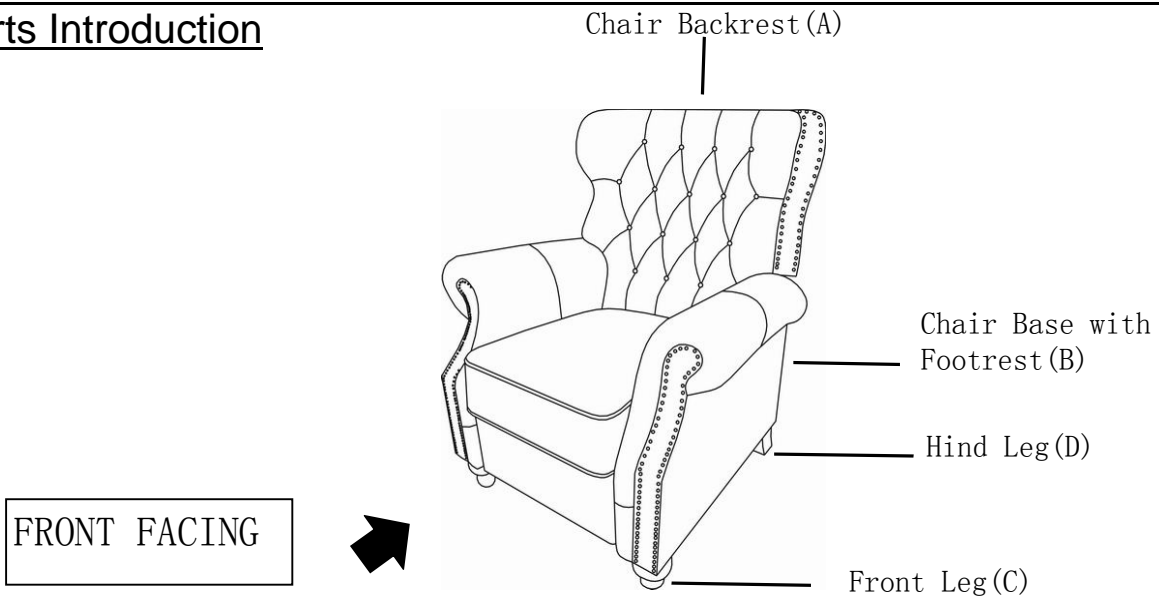

This Push Back Chair has multiple parts and may require up to some 30 minutes to assemble. To give you an overview of the Chair parts, the above picture is to help you put the various parts into perspective. Please read through the instructions below to familiarise yourself with the parts and steps before assembly.

Step 1

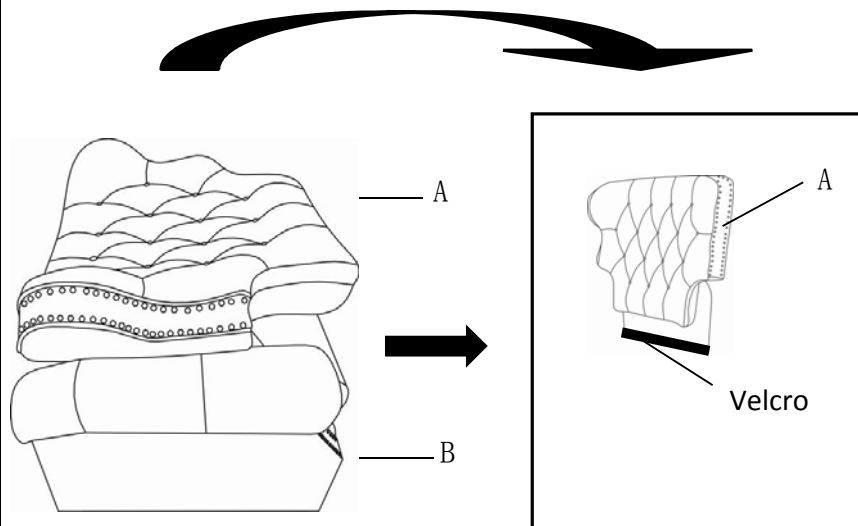

Take out the Chair Backrest(A) from Chair Base with Footrest(B).

Step 2

Chair Base (B)

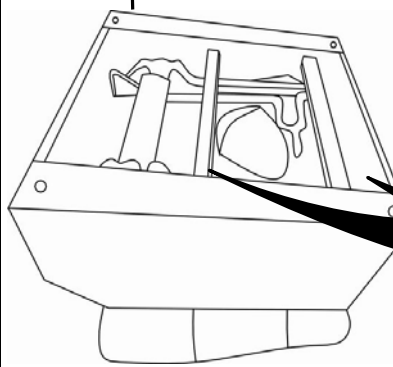

①

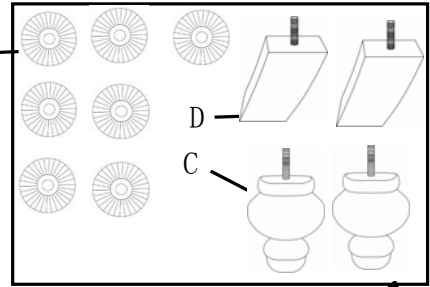

Non-woven Bag

Turn the Chair Base with Footrest(B) upside down on a clean, non-marring surface.

Open the non-woven bag and take out the Legs and Gaskets.

Step 3

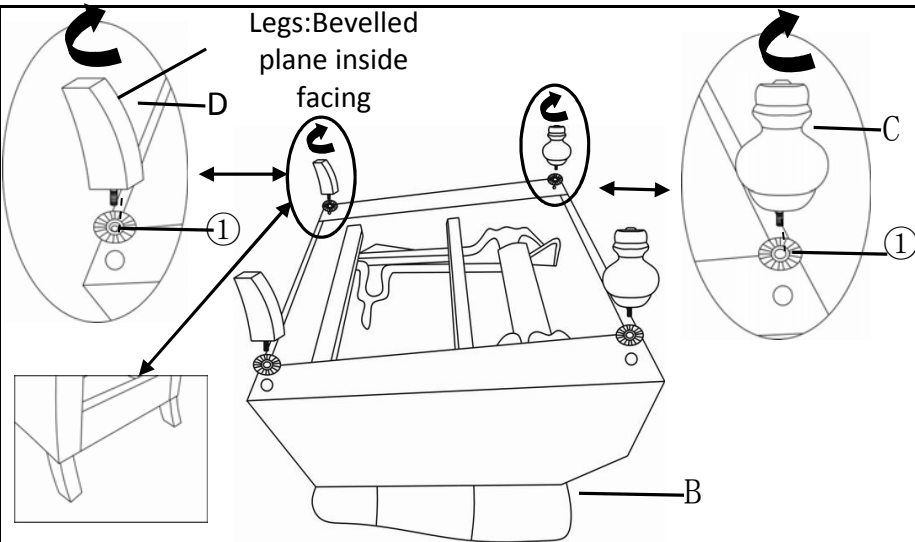

Install the Front Leg(C) at the bottom of the Chair by placing one Gasket① on the threaded stem.

Then insert threaded stem into the mounting position at the corner of the Chair.

Tighten by turning the Leg clockwise, Do not over tighten.

Repeat the same process to install the remaining three Legs.

Take care of the shape of the Legs and ensure they are in the correct positions.

Note: The use of Gaskets are OPTIONAL and are especially useful to help alleviate slight wobbleness. Some Legs may need more than one gasket whilst some legs may not need any.

Step 4

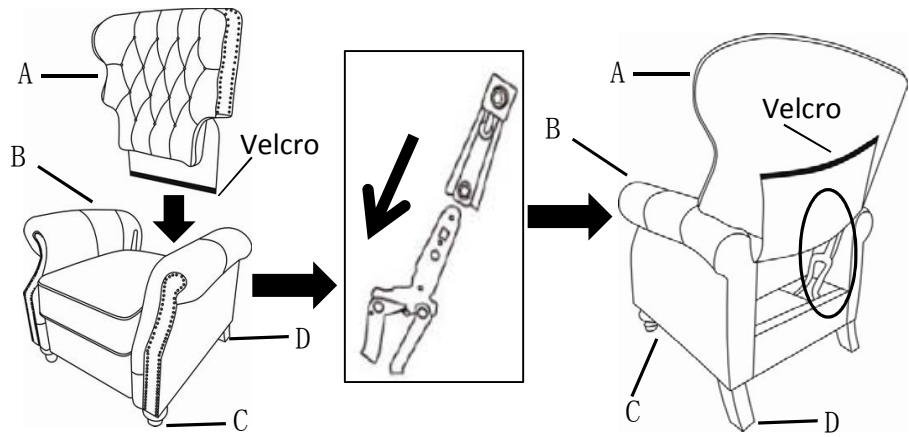

With assistance from your adult partner, hold up the fully assembled backrest , stand behind the chair.

Insert the small metal arms on the sides of the Chair Backrest into the prefabricated slide lock gadget on the Chair Base as shown above.

Firmly but gently, push the Chair Backrest downwards until the Backrest is fully slotted and locked into position.

Step 5

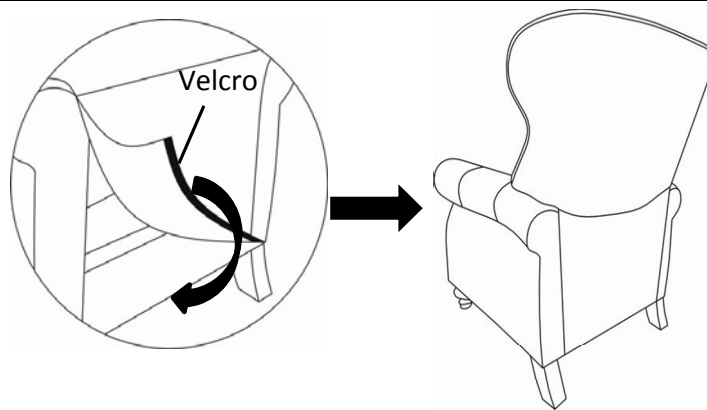

Smooth down the fabric flap on the Chair Backrest(A).

Run your hands down both sides of the flap, from top to bottom, allowing the velcro tape to adhere to the flap under the seat of the chair.

Step 6

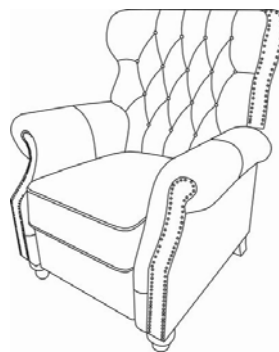

Make sure all parts are connected and securely locked into position.
Your Chair is ready for use..

Step 7

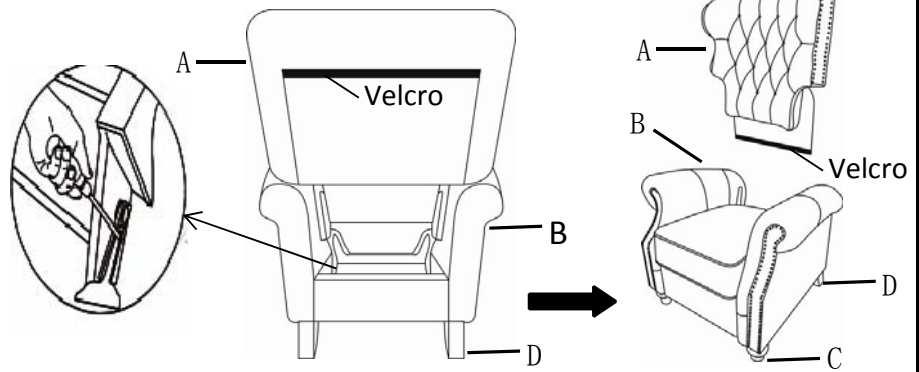

Disassembly Note: Open the flap on the Chair Backrest(A), use a screwdriver(Don't use fingers) pressing outward on the metal ear on the preattached Metal Bracket on one side of the Chair Base(B), with assistance of you adult partner to keep the Chair Base(B) in place, pull out the Chair Backrest(A) upward at the same time, repeat the same step for another side. Then the Chair Backrest(A) can be taken out.

User Instructions.

Push Back Chair

Please read the Instruction Manual below carefully before use.

Supervise children, when in use of this Push Back Chair.

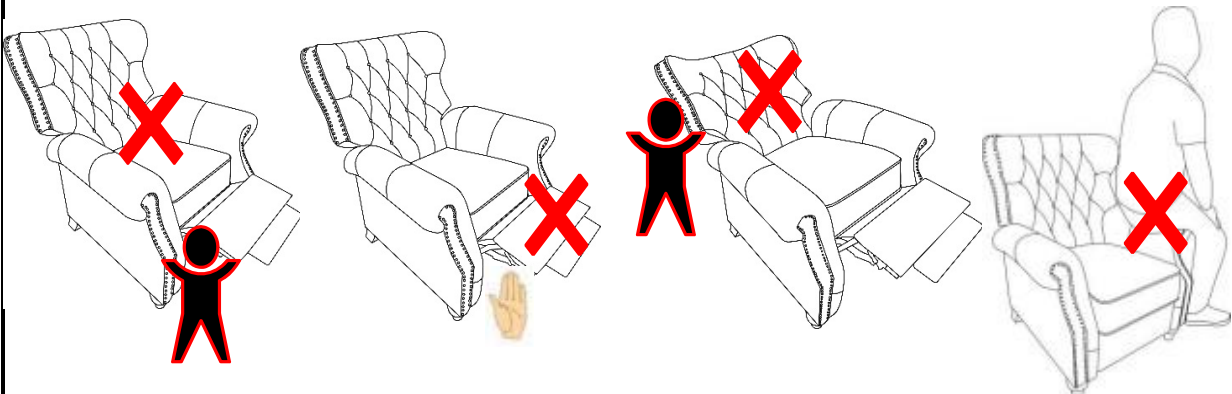

Do not let children stand in front of or behind the Push Back Chair when opening or closing the footrest. Do not put you hands inside the Footrest when opening or closing the footrest. Do not sit any armrest of Chair.

To get into a open position - To push the Chair Backrest

Sit into the seat.

Place your feet apart .

Place your left and right arm onto the armrest.

Synchronise a backward push with your arms.

Use your body weight and push backwards into the seat into a fully reclined position.

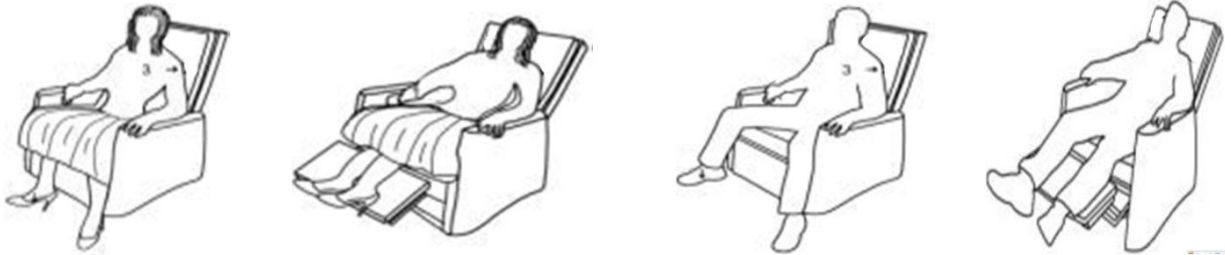

To get out of chair - move Seatback into Upright Position

Tilt your body weight slightly forward and upwards.

The seat back will come up to an upright position.







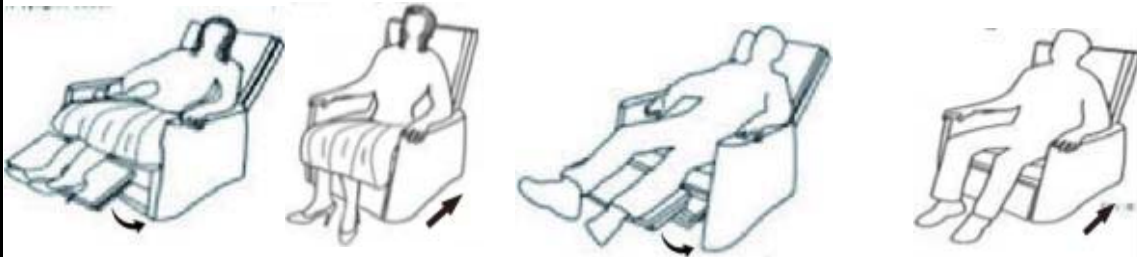



Use your feet to push the footrest down.

The chair will automatically lock when it is in the fully upright position.

Where necessary, use your arms help lift/push yourself out of the seat.



Care & Maintenance

-  Do not put hot items directly on furniture surface
 -  Do not clean furniture with harsh cleansers or polish.
 -  Do not place furniture under direct sunlight.
 -  Do not place furniture near heating or cooling vents.
 -  Do not write on furniture without a padded barrier to protect the surface.
 -  Do not place furniture outside . For indoor use only .
 -  Not for commercial use. For residential use only .
 -  Stains may be removed with mild soap solution and damp cloth.
 -  Children should not climb or jump on the furniture.
-
-  Dust and pick-up spills using a clean, non-colored, lint-free cloth .