

# ASSEMBLY INSTRUCTIONS

---

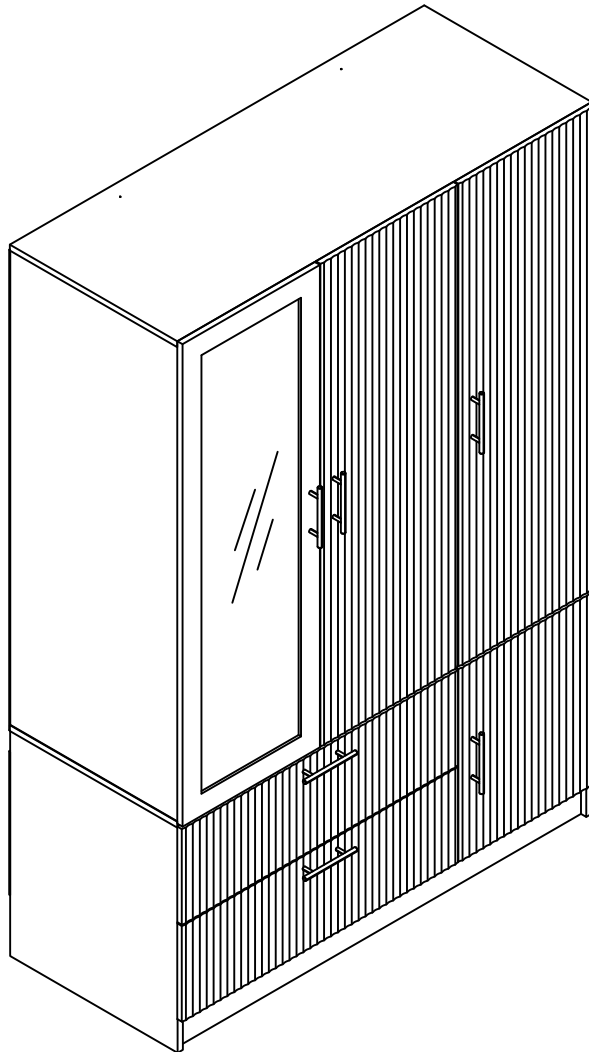

## ⚠ SAFETY TIPS:

Static charge may cause dust on foam-clean with a dry or damp cloth. Small foam strands may be present-handle gently and dispose of properly. Do not burn or incinerate. Check local recycling guideline.

Have an assembly question or need a replacement part?  
Please contact with our customer service.

# Warnings

Important reminder:

- ⚠ Please sort and check all accessories before assembly.
  - ⚠ Place the product on an empty cardboard box or on carpet to prevent scratches.
  - ⚠ Please use proper tools for assembly. Using an electric screwdriver can accelerate the assembly speed, but please do not overtighten the screws.
  - ⚠ Please follow the assembly steps and do not skip any of them.
  - ⚠ If possible, please find a partner to help you with assembly, which can accelerate assembly.
  - ⚠ Keep all small parts of this product away from children. They may cause serious injury.
  - ⚠ We hope you can retighten the screws 2 weeks after assembly, and check the tightening procedure of the screws every 3 months.
- If you meet any difficulty, our friendly customer team are always ready to help you.

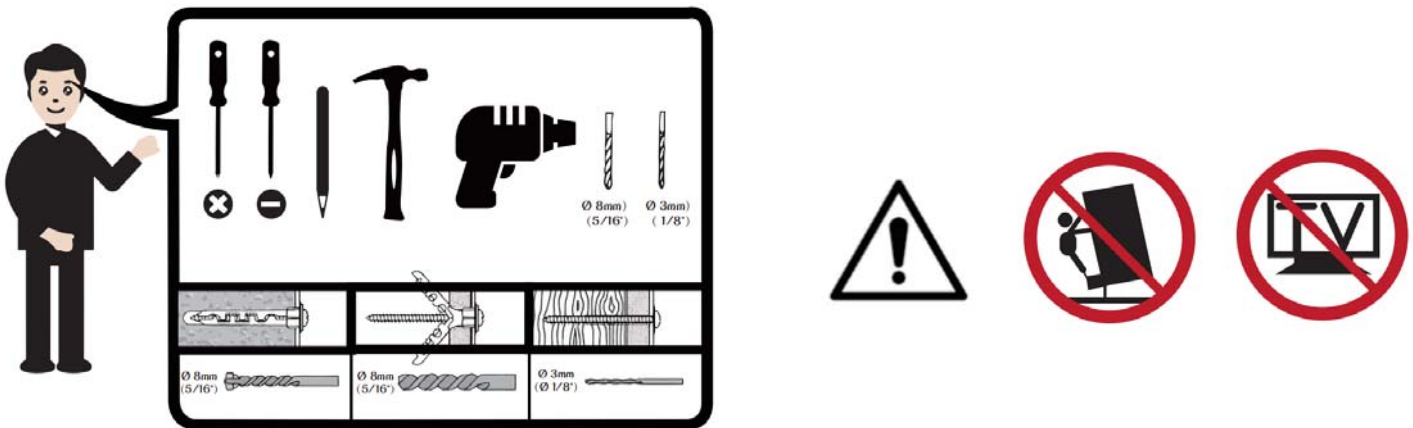

Warning: Overturning the product can cause serious crushing injuries. We have a wall connection device attached, please use it to hold the furniture following assembly instructions. Do not change the structure of this product in way. Our products have been tested and meet any 1 sales specific security measures. We won't be responsible for any modifications, which may cause significant security risks.

# Explosion Diagram

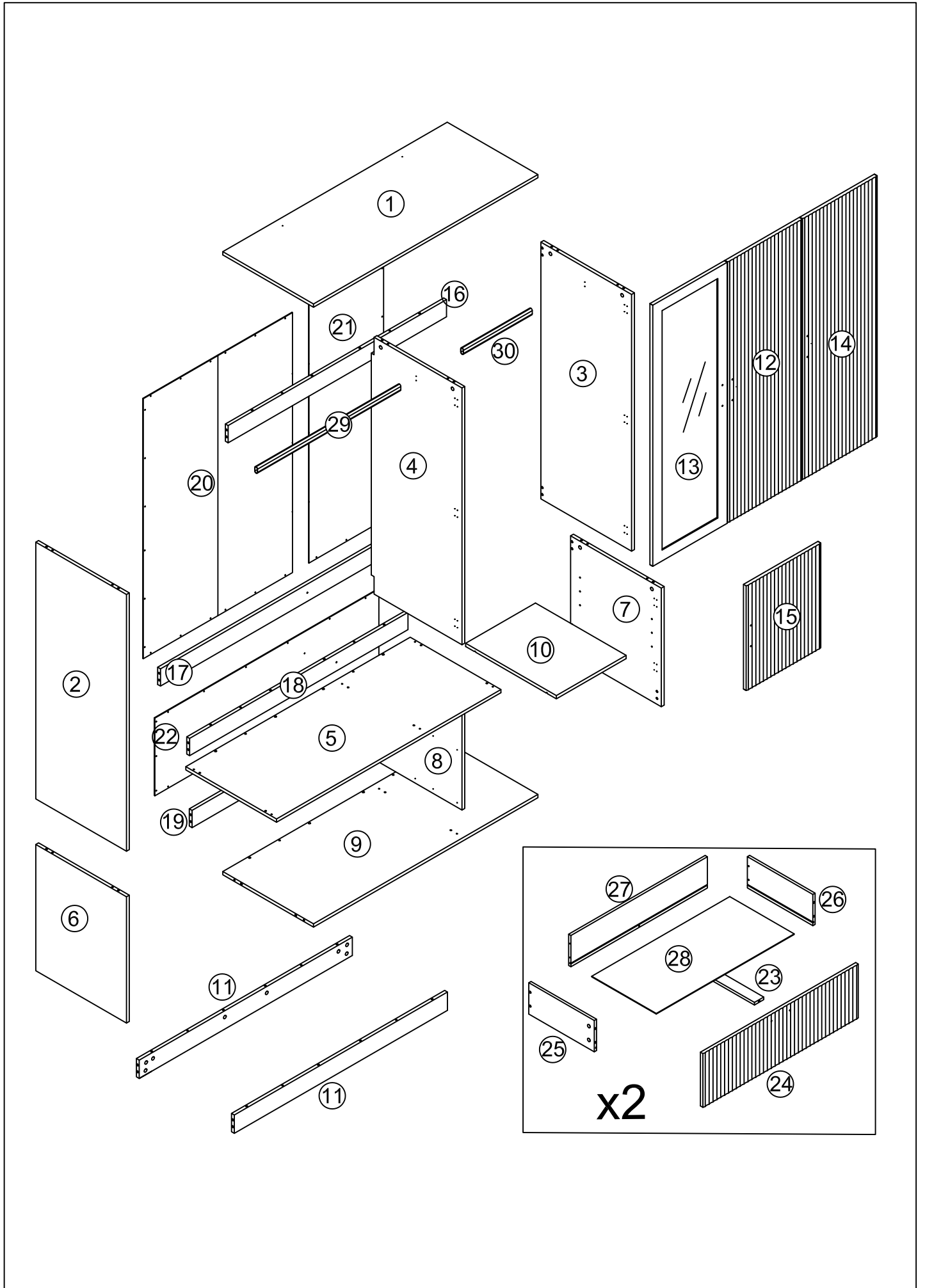

# Parts List

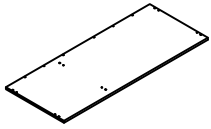

① X1

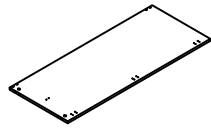

② X1

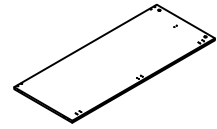

③ X1

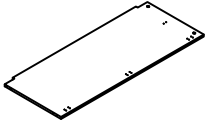

④ X1

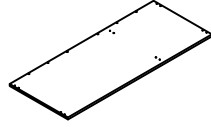

⑤ X1

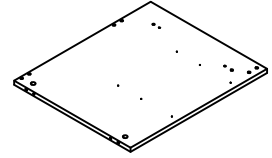

⑥ X1

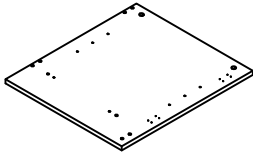

⑦ X1

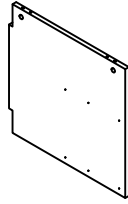

⑧ X1

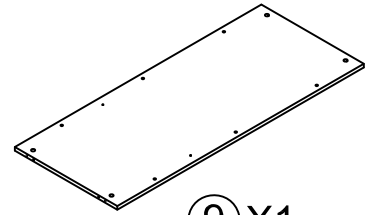

⑨ X1

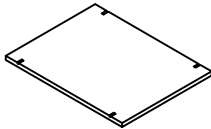

⑩ X1

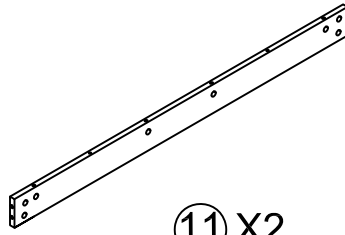

⑪ X2

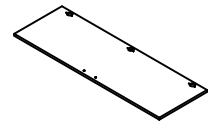

⑫ X1

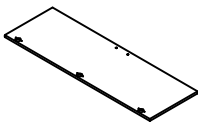

⑬ X1

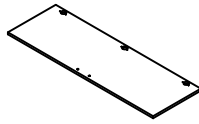

⑭ X1

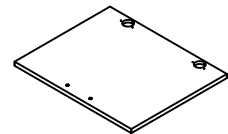

⑮ X1

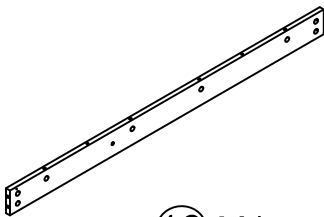

⑯ X1

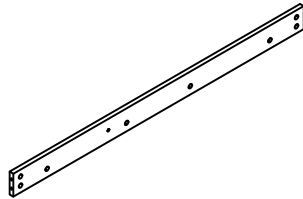

⑰ X1

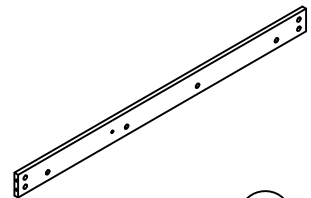

⑱ X1

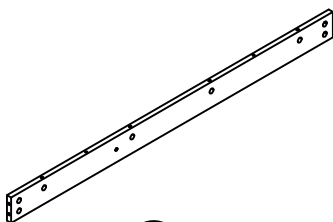

⑲ X1

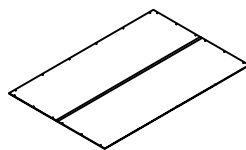

⑳ X1

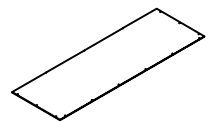

㉑ X1

# Parts List

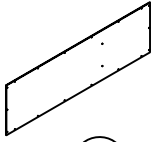

②② X1



②③ X2

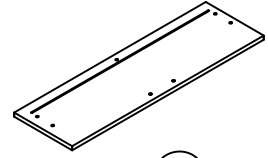

②④ X2



②⑤ X2



②⑥ X2

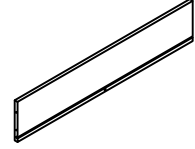

②⑦ X2

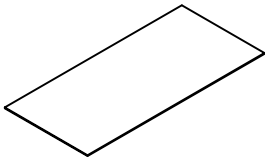

②⑧ X2

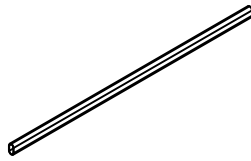



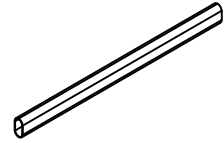





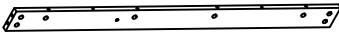

②⑨ X1

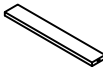
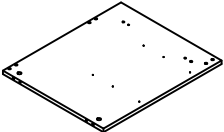
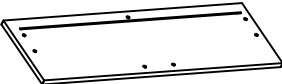
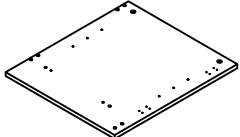
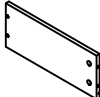
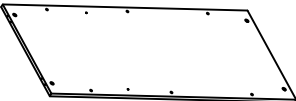
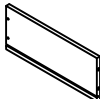
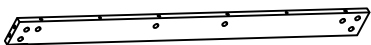

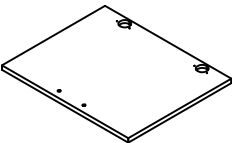
③⑩ X1

## Box A Parts List

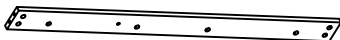
This product is packaged in two boxes. This is the first box, while the remaining components are in the second box. Ensure all packaging is received before installation

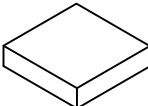
| Item no. | Reference Image   | Qty. | Item no. | Reference Image  | Qty. |
|----------|---|------|----------|--|------|
| ②        |    | 1    | ①9       |                      | 1    |
| ③        |    | 1    | ②3       |                     | 2    |
| ⑥        |    | 1    | ②4       |                     | 2    |
| ⑦        |    | 1    | ②5       |                     | 2    |
| ⑨        |   | 1    | ②6       |                    | 2    |
| ①1       |  | 2    | ②7       |                   | 2    |
| ①5       |  | 1    | ②8       |                   | 2    |
| ①6       |  | 1    | ②9       |                   | 1    |
| ①7       |  | 1    | ③0       |                   | 1    |
| ①8       |  | 1    |          | <br>HARDWARE PACK | 1    |

If you encounter any problems during installation, Please contact our customer service.

## Box B Parts List

Assembly steps refer to assembly instructions from Box A

This product is packaged in two boxes. This is the second box, while the other components are in the first box. Ensure all packages are received before proceeding with installation

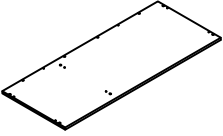
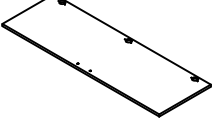
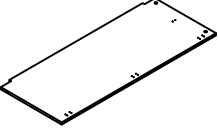
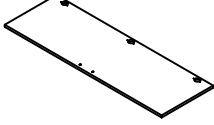
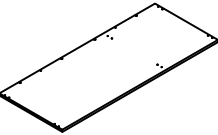
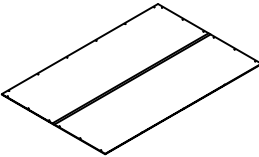
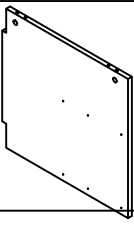
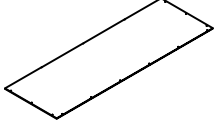
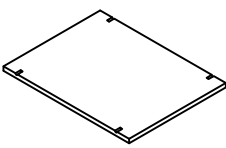
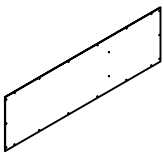
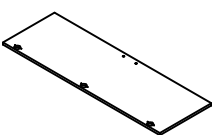
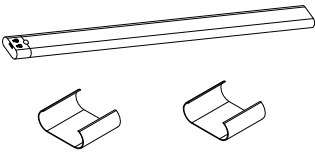
| Item no. | Reference Image   | Qty. | Item no.   | Reference Image   | Qty. |
|----------|---|------|------------|---|------|
| ①        |    | 1    | ⑬          |    |      |
| ④        |    |      | ⑭          |    |      |
| ⑤        |    |      | ⑳          |    |      |
| ⑧        |  |      | ㉑          |  |      |
| ⑩        |  |      | ㉒          |  |      |
| ⑫        |  |      | <b>LED</b> |  |      |











If you encounter any problems during installation, Please contact our customer service.

## Hardware List

| No. | Code      | Diagram   | Description  | Quantity | Spare |
|-----|-----------|---|--------------|----------|-------|
| 1   | <b>A1</b> |    |              | 74       | 2     |
| 2   | <b>A2</b> |    | Ø15 x 9.5 mm | 74       | 2     |
| 3   | <b>B1</b> |    | M3.5 x 12 mm | 24       | 2     |
| 4   | <b>B2</b> |    | M4 x 14 mm   | 66       | 2     |
| 5   | <b>B3</b> |    | M3 x 12 mm   | 47       | 2     |
| 6   | <b>B4</b> |    | M4 x 12 mm   | 8        |       |
| 7   | <b>B5</b> |    | M5 x 40 mm   | 8        |       |
| 8   | <b>B6</b> |    | M4 x 30 mm   | 14       | 1     |
| 9   | <b>C1</b> |    | Ø6 x 30 mm   | 32       | 2     |
| 10  | <b>C2</b> |  |              | 3        |       |
| 11  | <b>C3</b> |  |              | 8        |       |
| 12  | <b>C4</b> |  |              | 4        |       |
| 13  | <b>C5</b> |  |              | 4        |       |
|     |           |  |              | 4        |       |
| 14  | <b>C6</b> |  |              | 20       | 2     |
| 15  | <b>C7</b> |  |              | 6        |       |

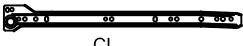
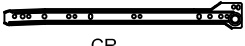
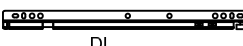
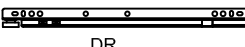
THE SPARE BAG INCLUDED EXTRA HARDWARE FOR DAMAGED OR MISSING SMALL HARDWARE WHILE YOU ARE ASSEMBLING



# Hardware List

| No. | Code       | Diagram   | Description   | Quantity | Spare |
|-----|------------|---|---|----------|-------|
| 16  | <b>D1</b>  |                        |   | 2        |       |
|     |            |                        | M4 x 12 mm  | 2        |       |
|     |            |                        | M4 x 35 mm  | 2        |       |
|     |            |                        |   | 2        |       |
| 17  | <b>D2</b>  |                        |   | 6        |       |
|     |            |                        | M4 x 18 mm  | 12       | 1     |
| 18  | <b>D3</b>  |                        |   | 12       | 1     |
| 19  | <b>CL</b>  | <br>CL                 | 14" Slide (CR)  | 2        |       |
|     | <b>CR</b>  | <br>CR                 | 14" Slide (CL)  | 2        |       |
|     | <b>DL</b>  | <br>DL                 | 14" Slide (DR)  | 2        |       |
|     | <b>DR</b>  | <br>DR               | 14" Slide (DL)  | 2        |       |
| 20  | <b>LED</b> |                      |   | 1        |       |
|     |            |                      |   | 2        |       |
| 21  |            | <br><b>SPARE BAG</b> | Please put the hardware of +2 in the self sealing bag |          |       |

THE SPARE BAG INCLUDED EXTRA HARDWARE FOR DAMAGED OR MISSING SMALL HARDWARE WHILE YOU ARE ASSEMBLING

# Assemble

Step 1

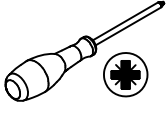
|   |   |   |   |
|---|---|---|---|
|  |  |  |  |
| A1 8PCS   | C5 4PCS   | B4 8PCS   |   |

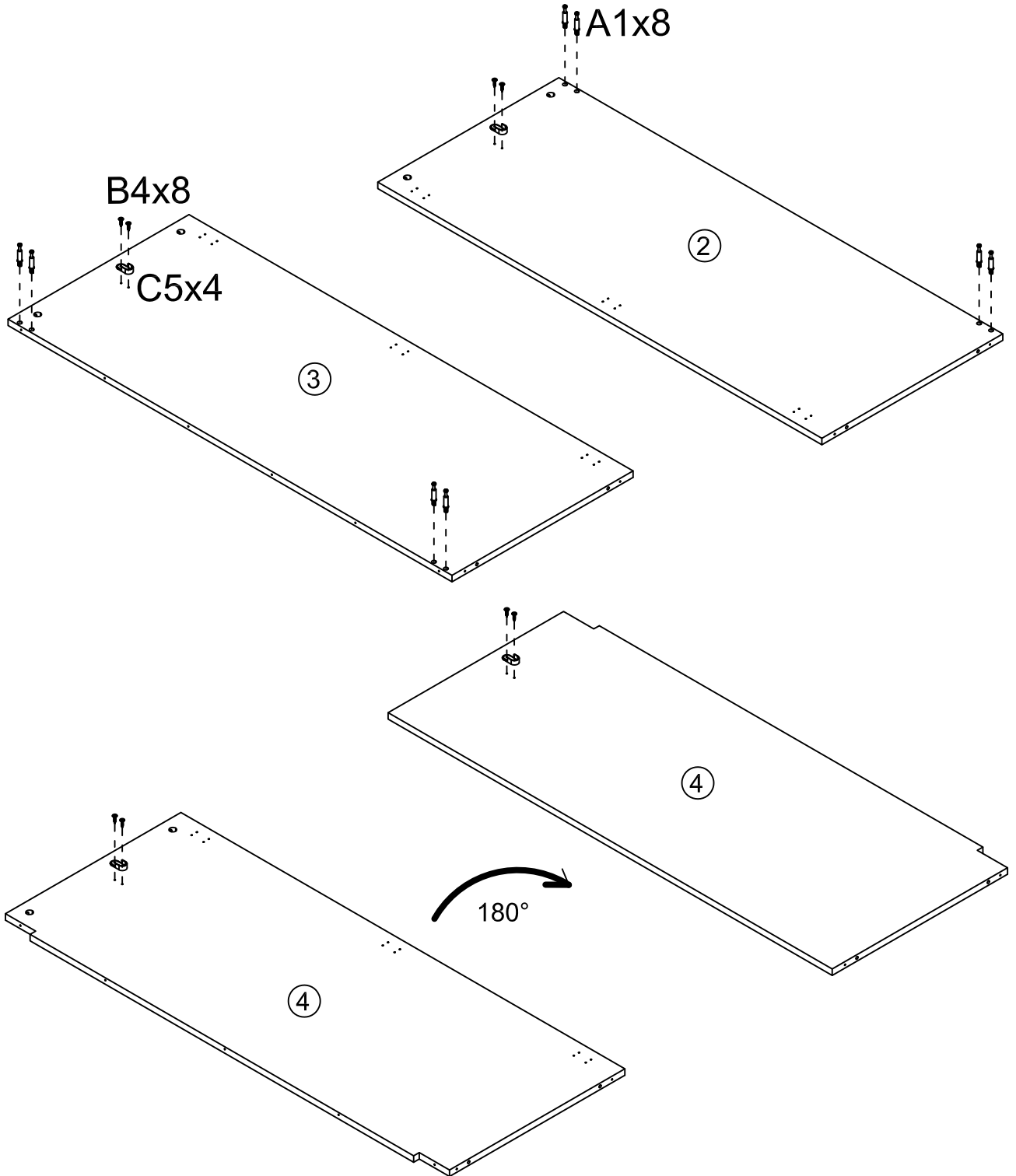
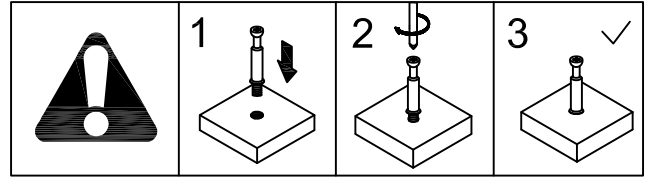

# Assemble

Step 2

|   |   |    |      |   |
|---|---|----|------|---|
|  |  |    |      |  |
| B6  | 2PCS  | A2 | 4PCS |   |

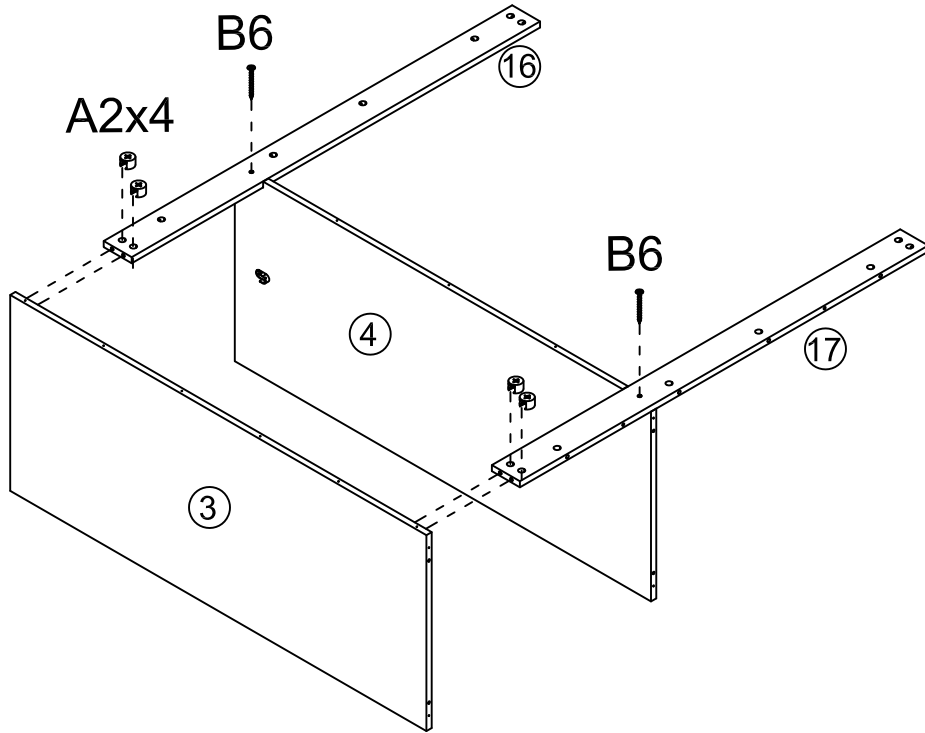

Step 3

|   |      |  |   |
|---|------|--|---|
|  |      |  |  |
| A2  | 4PCS |  |   |

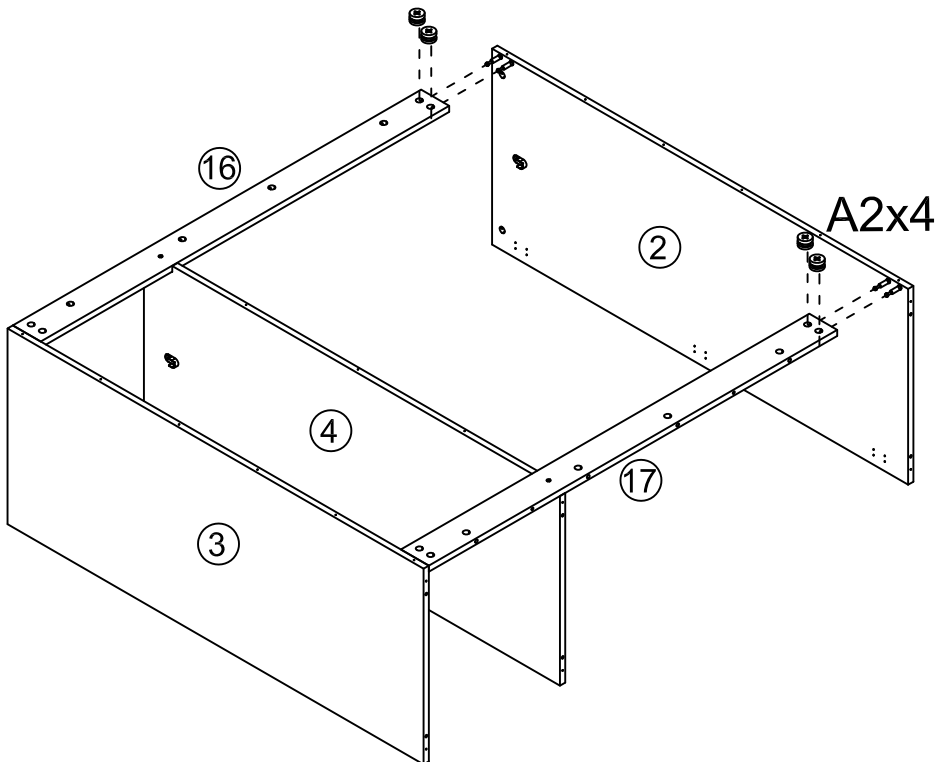

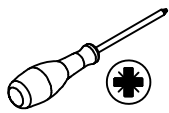

# Assemble

Step 4

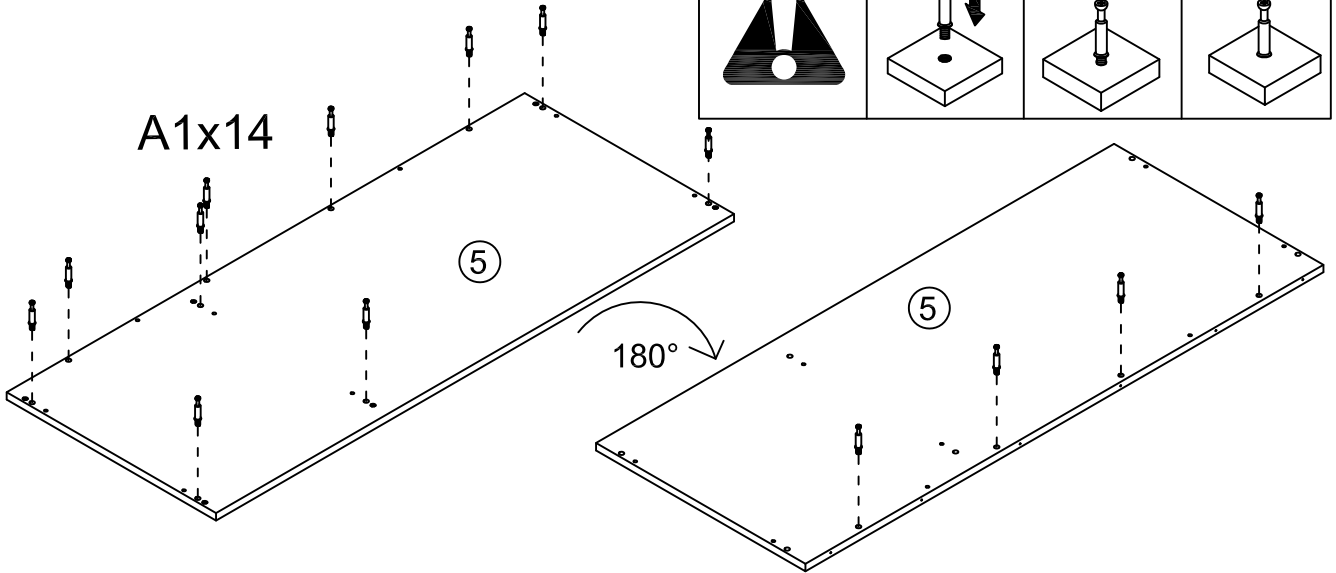
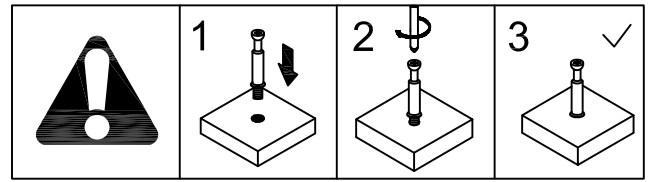
|   |       |   |  |
|---|-------|---|--|
|  |       |  |  |
| A1  | 14PCS |   |  |



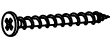

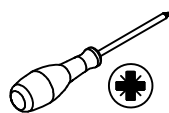
Step 5

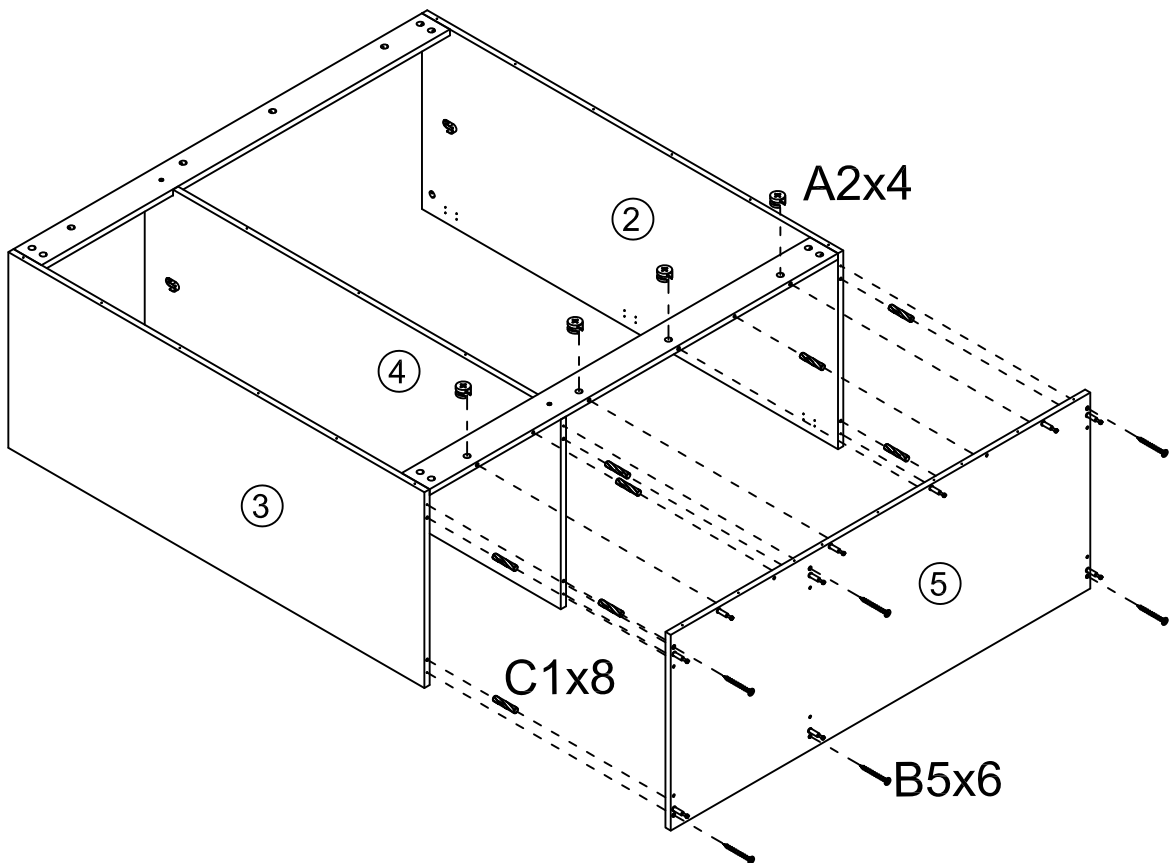
|   |   |   |   |      |
|---|---|---|---|------|
|  |  |  |  |      |
| B5  | A2  | C1  | 6PCS  | 4PCS |
|   |   |   | 8PCS  |      |



# Assemble

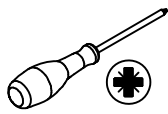

Step 6

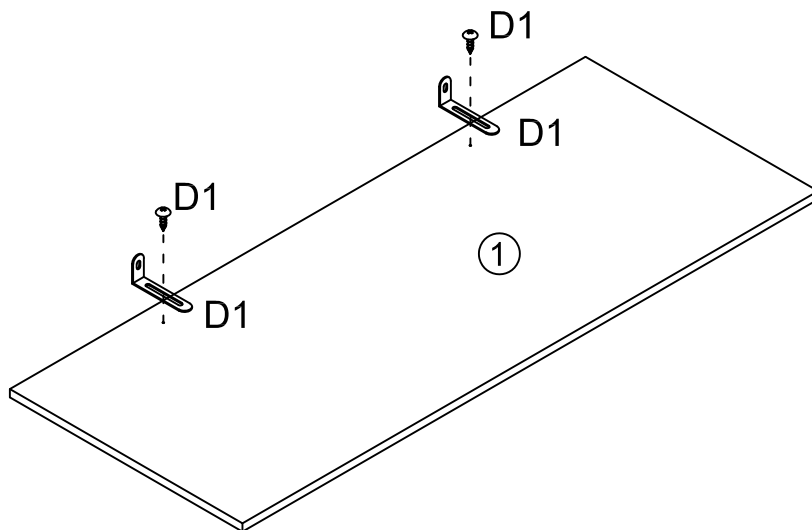
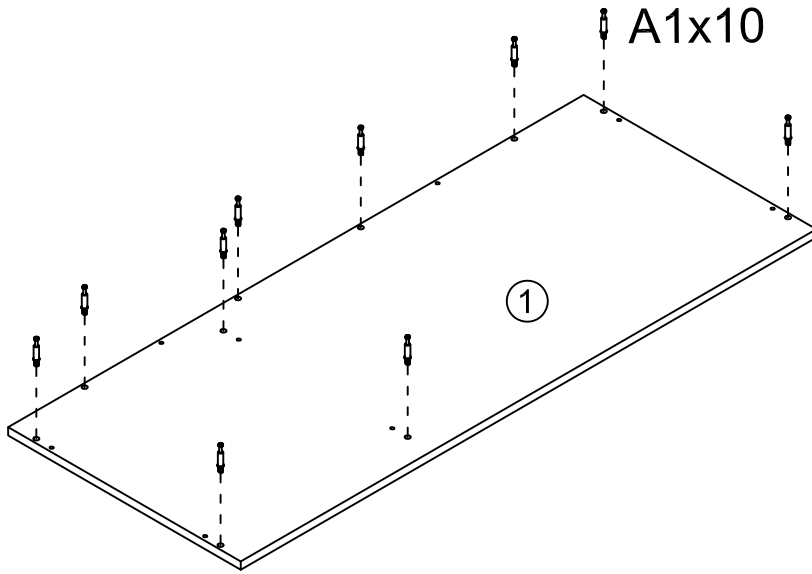
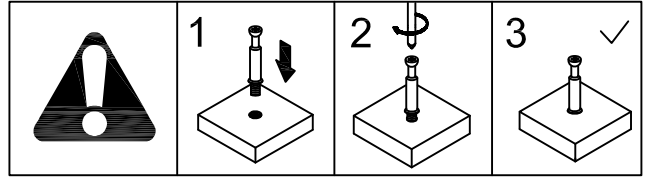
|   |   |   |   |    |      |
|---|---|---|---|----|------|
|  |  |  |  |    |      |
| A1  | 10PCS   | D1  | 2PCS  | D1 | 2PCS |



# Assemble

Step 7

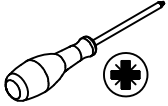
|   |       |   |      |       |   |
|---|-------|---|------|-------|---|
|  |       |  |      | A2x10 |  |
| A2  | 10PCS | C1  | 8PCS |       |   |

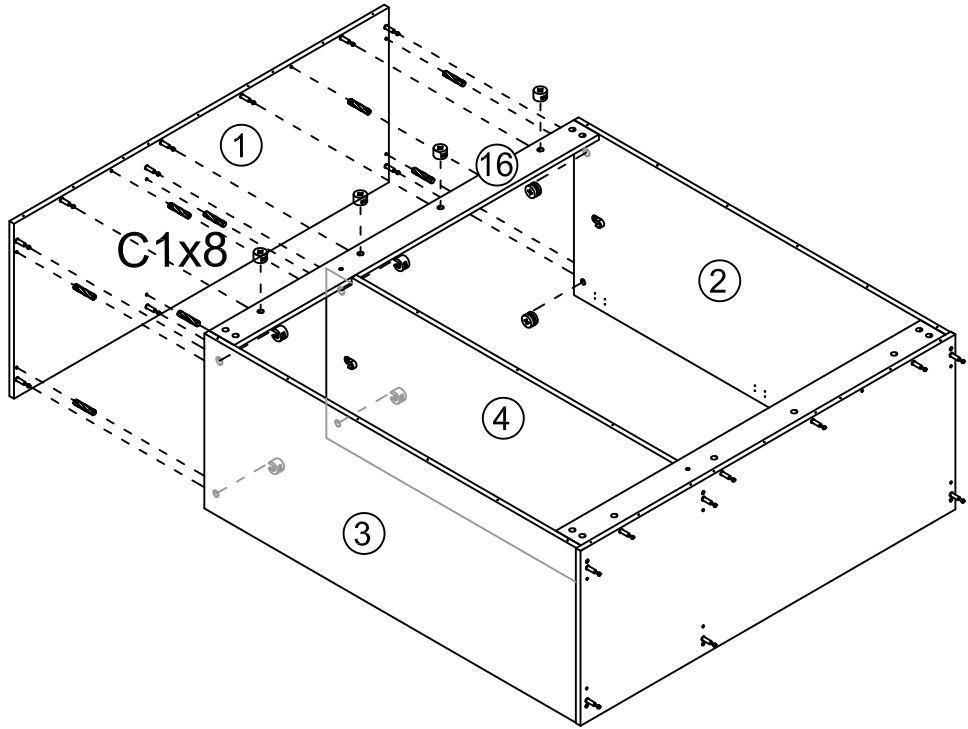

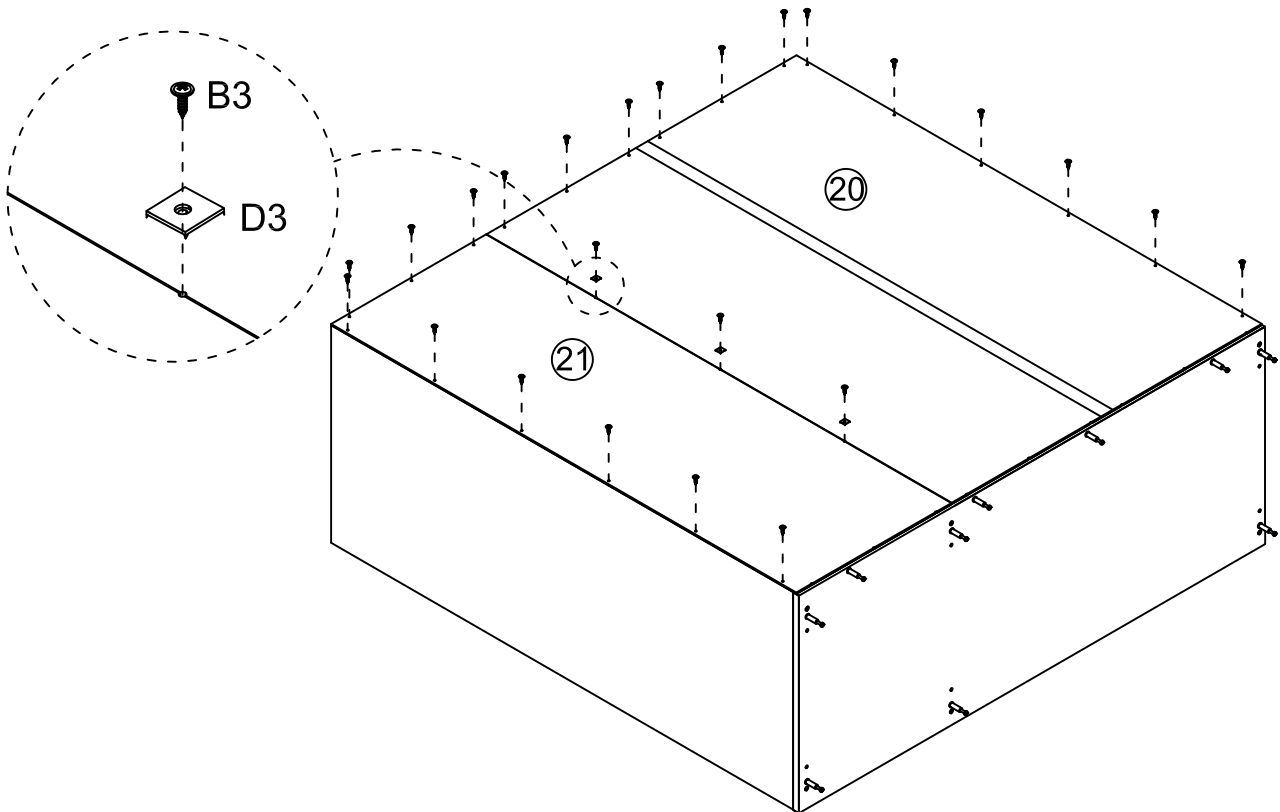

Step 8

|   |       |   |      |       |   |
|---|-------|---|------|-------|---|
|  |       |  |      | B3x24 |  |
| B3  | 24PCS | D3  | 3PCS |       |   |



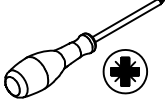

# Assemble

Step 9

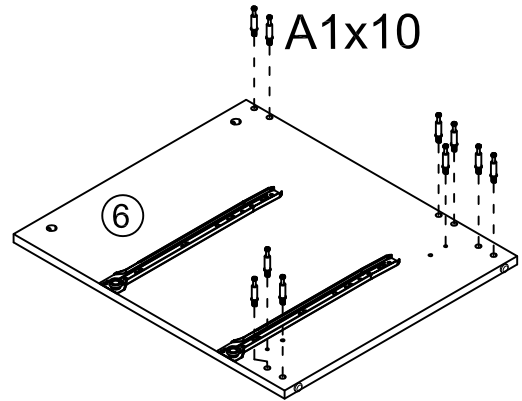
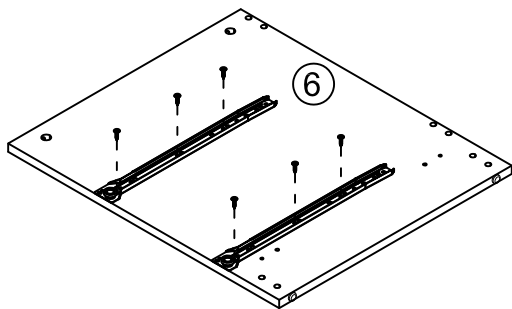
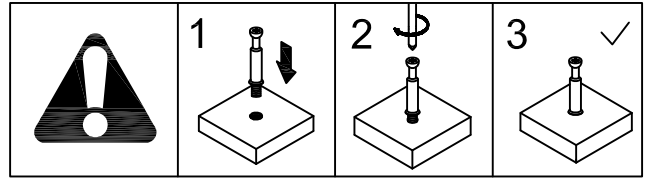
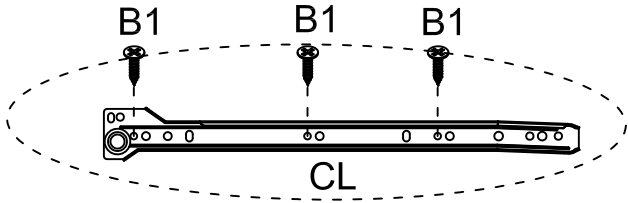
|   |   |   |   |
|---|---|---|---|
|  |  |  |  |
| A1 10PCS  | CL 2PCS   | B1 6PCS   |   |

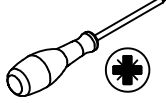

Step 10

|   |   |   |   |
|---|---|---|---|
|  |  |  |  |
| A1 10PCS  | CR 2PCS   | B1 6PCS   |   |

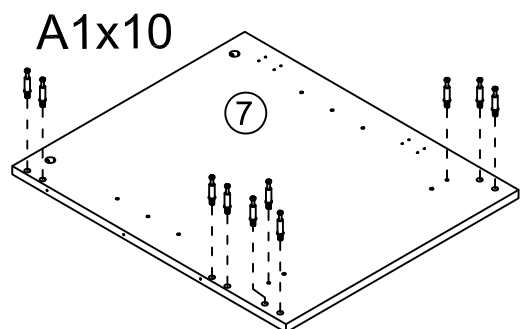
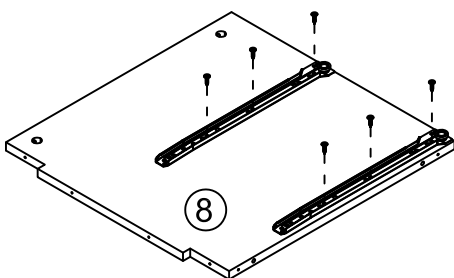
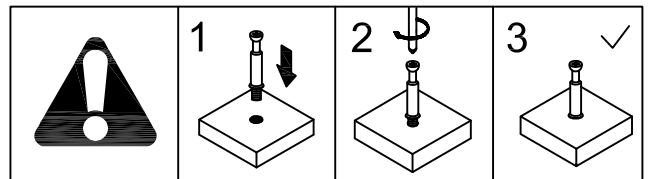
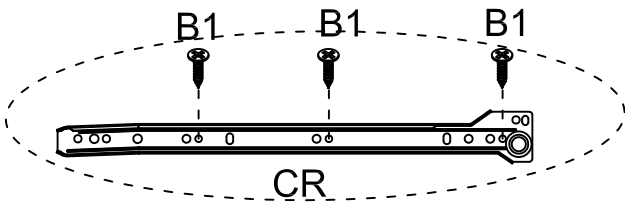

# Assemble

Step 11

|   |      |   |
|---|------|---|
|  |      |  |
| A1  | 8PCS |   |

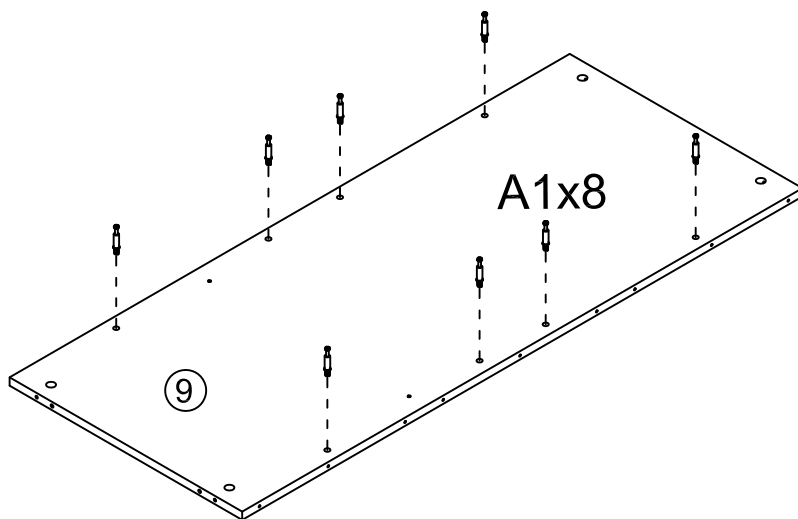
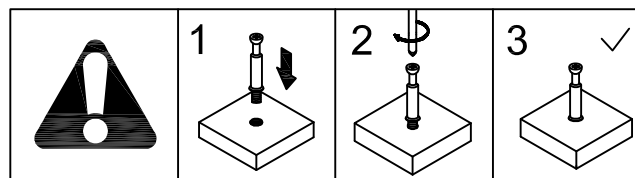

Step 12

|   |      |   |
|---|------|---|
|  |      |  |
| A2  | 8PCS |   |

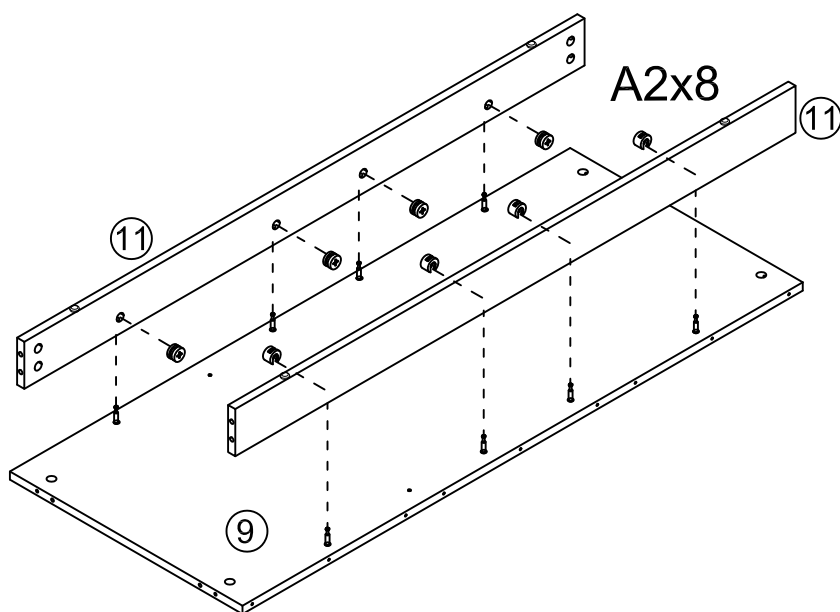

# Assemble

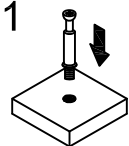
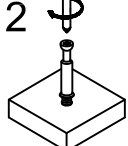
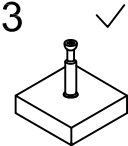

Step 13

|   |      |  |  |   |
|---|------|--|--|---|
|  |      |  |  |  |
| A1  | 4PCS |  |  |   |

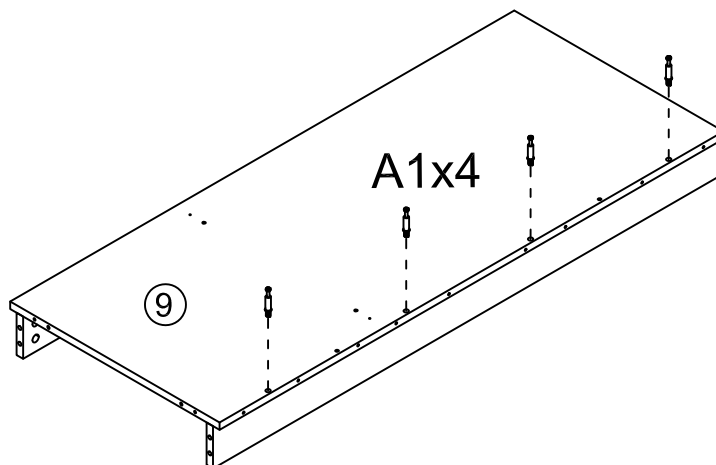
|   |   |   |   |
|---|---|---|---|
|  | 1  | 2  | 3  |
|---|---|---|---|

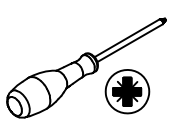

Step 14

|   |   |    |      |   |
|---|---|----|------|---|
|  |  |    |      |  |
| C1  | 2PCS  | A2 | 4PCS |   |

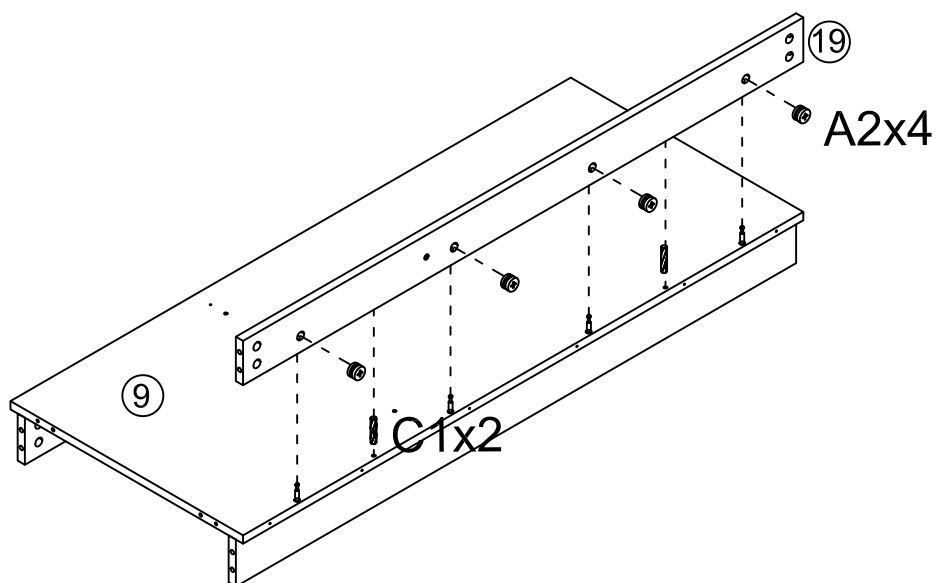



# Assemble

Step 17

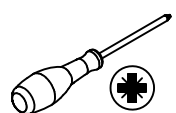
|   |   |    |       |   |
|---|---|----|-------|---|
|  |  |    |       |  |
| C1  | 2PCS  | A2 | 10PCS |   |

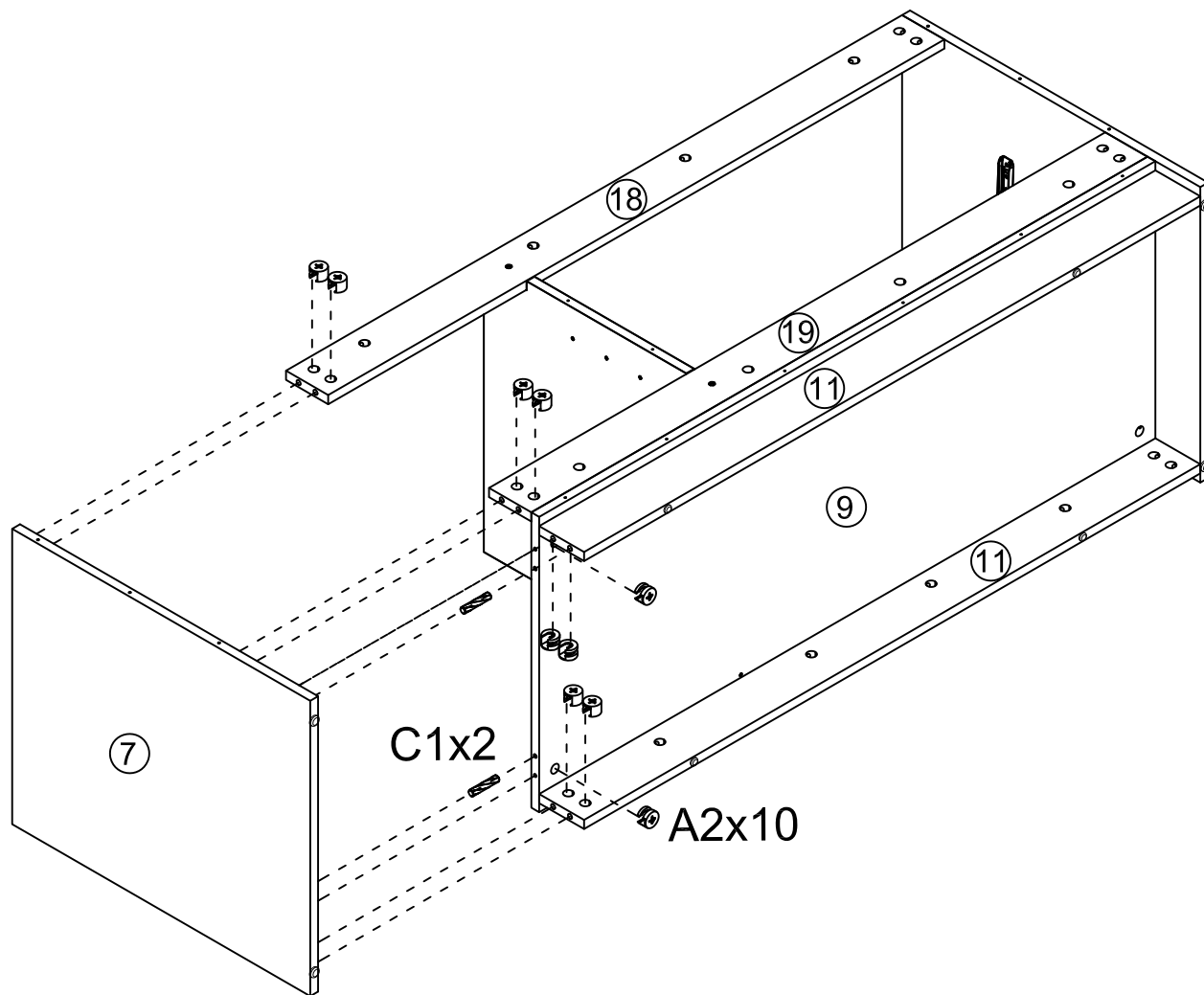

# Assemble

Step 18

|   |      |   |       |   |
|---|------|---|-------|---|
|  |      |  |       |  |
| C1  | 8PCS | A2  | 10PCS |   |

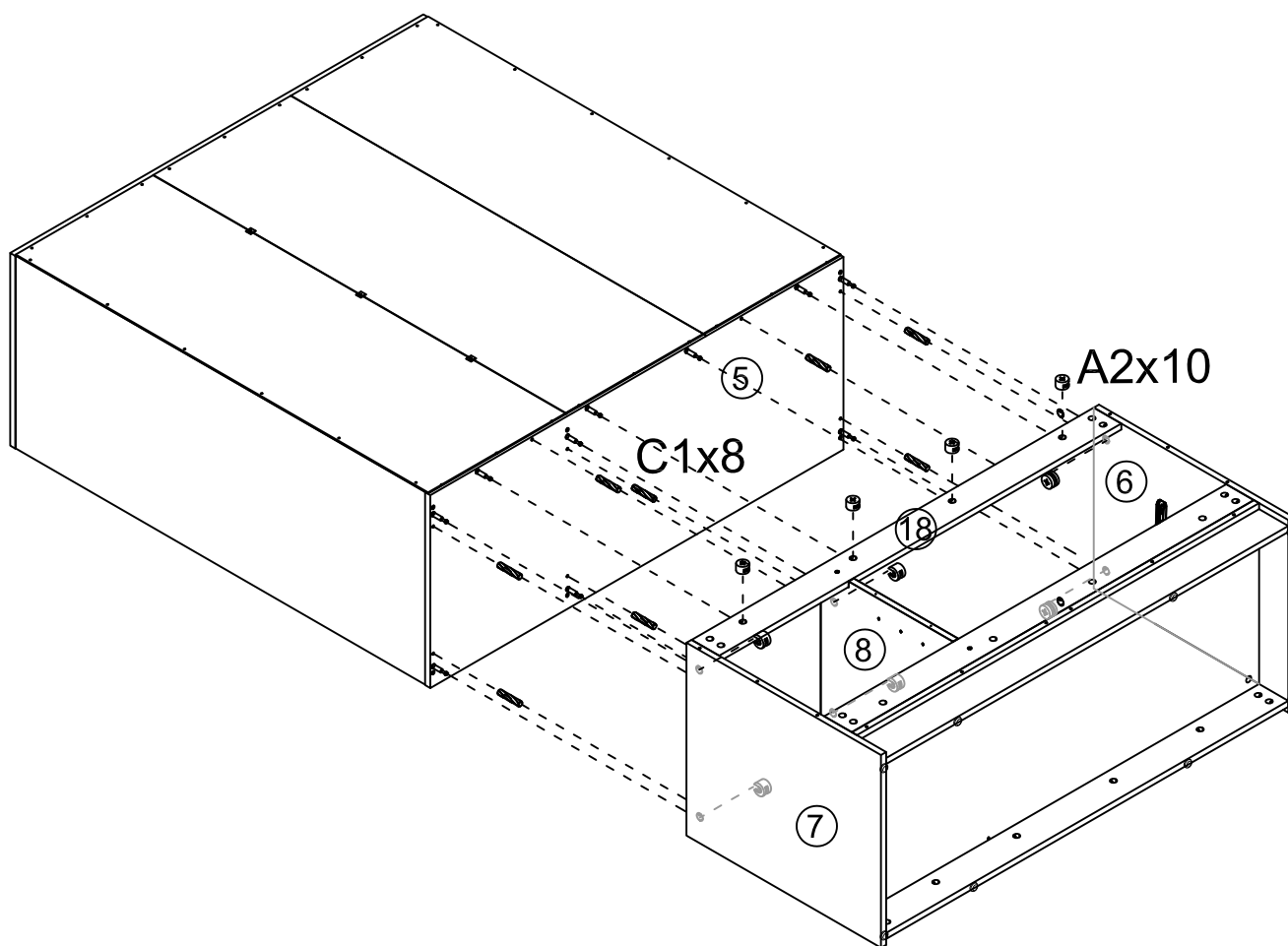

# Assemble

Step 19

|   |       |   |      |   |
|---|-------|---|------|---|
|  |       |  |      |  |
| B3  | 23PCS | D3  | 9PCS |   |

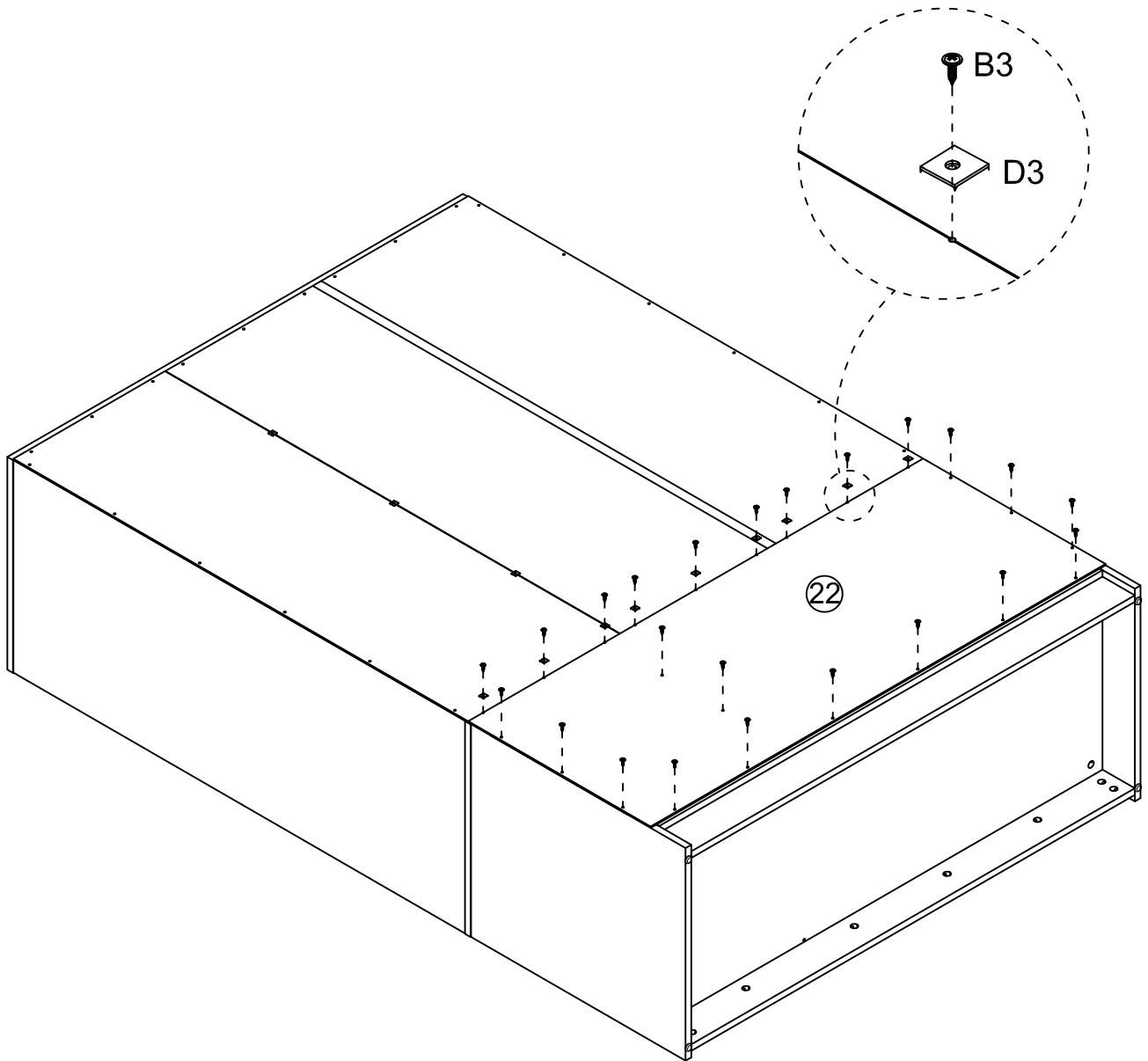

# Assemble

Step 20

|   |      |   |
|---|------|---|
|  |      |  |
| C5  | 4PCS |   |

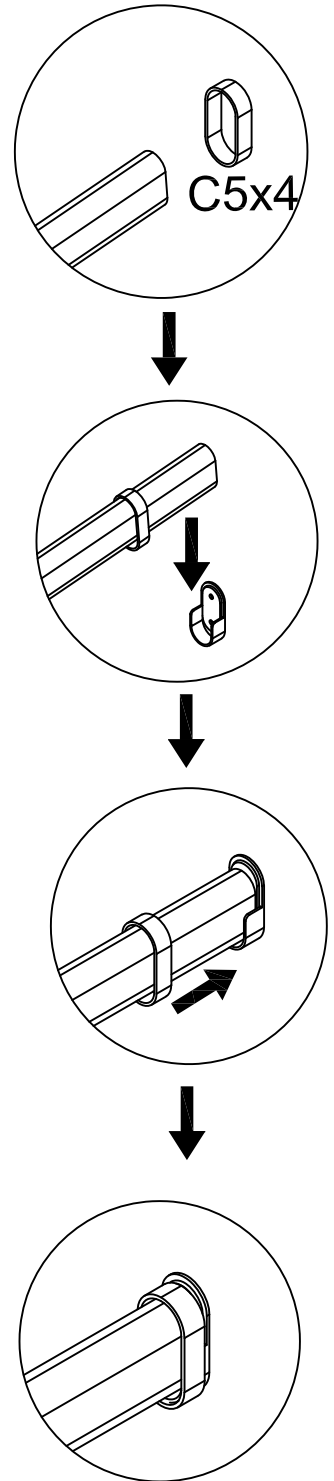
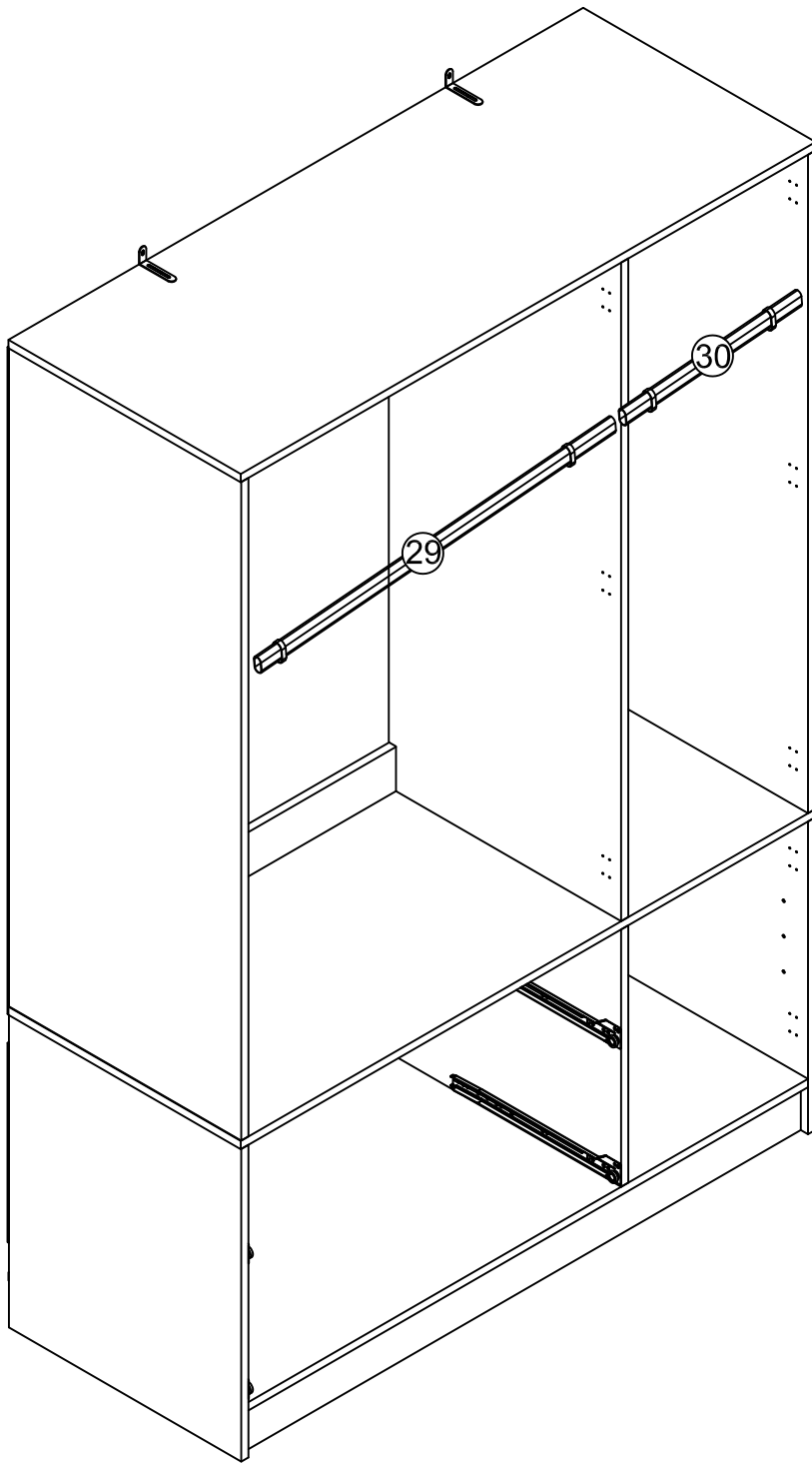

# Assemble



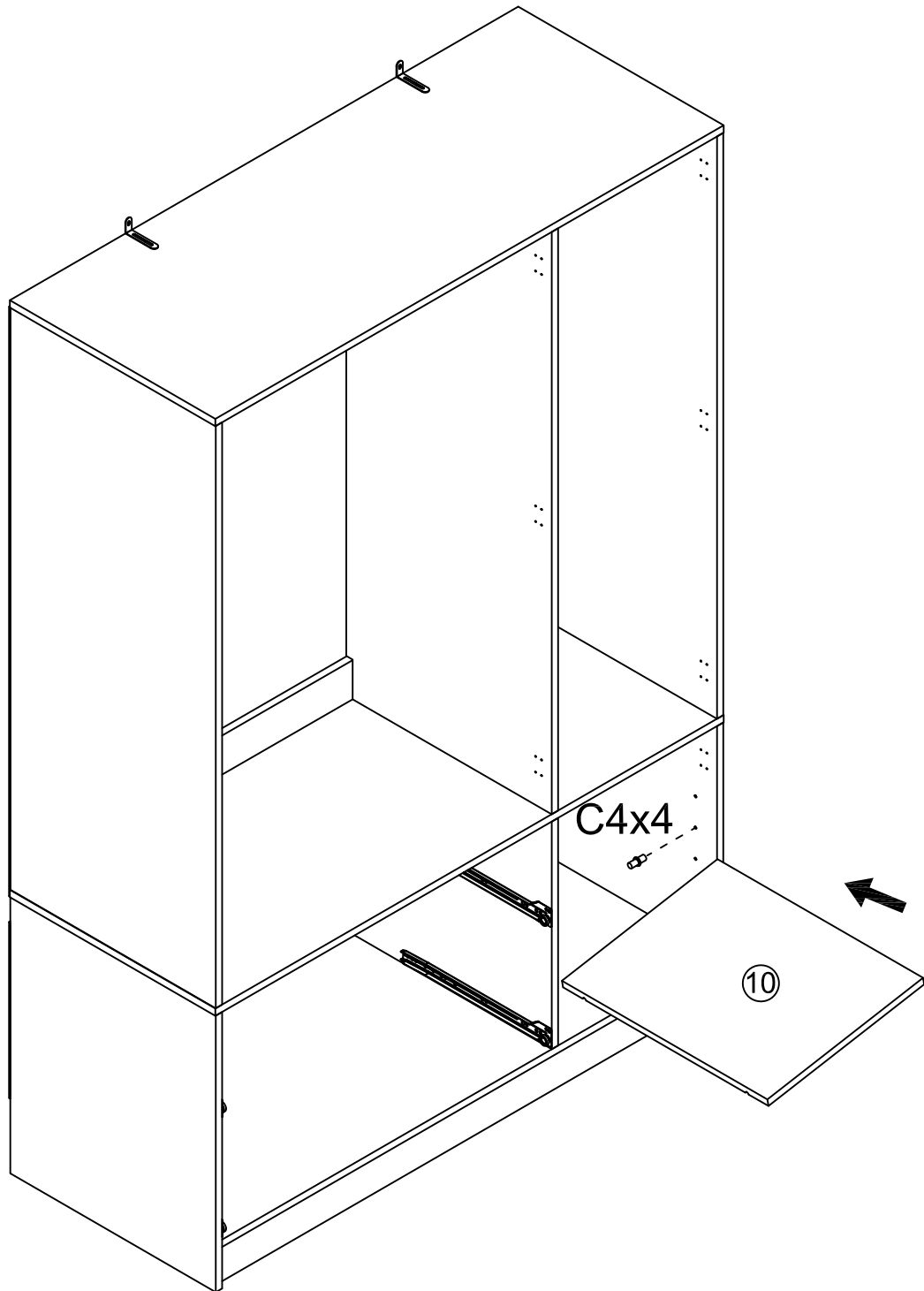

Step 21

|   |      |   |
|---|------|---|
|  |      |  |
| C4  | 4PCS |   |





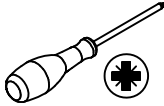

# Assemble

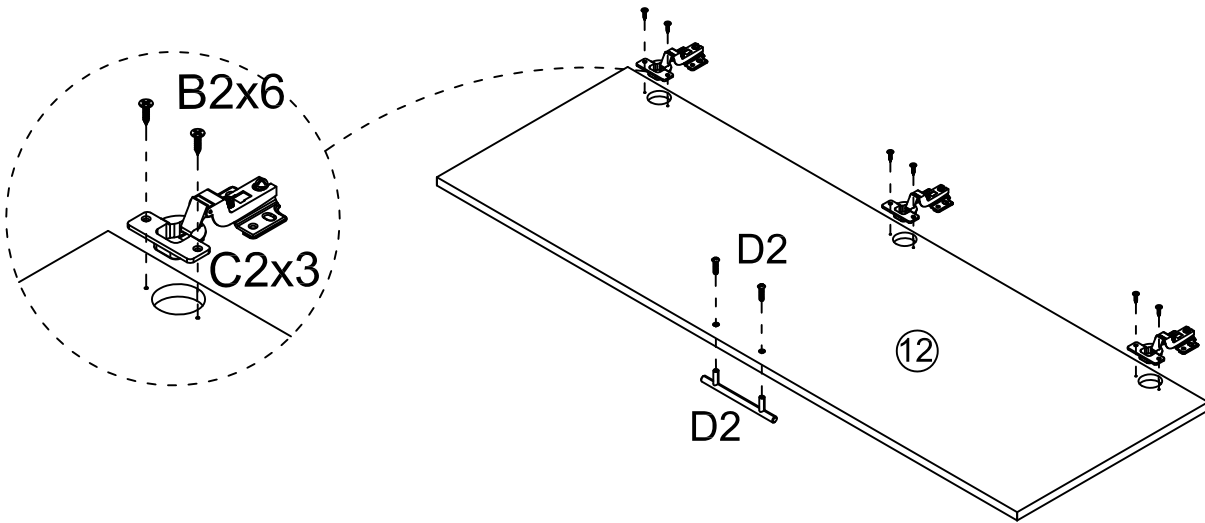
Step 22

|   |   |   |   |   |
|---|---|---|---|---|
|  |  |  |  |  |
| B2   6PCS   | C2   3PCS   | D2   1PCS   | D2   2PCS   |   |

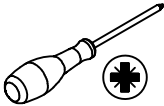

Step 23

|  |  |  |  |  |
|--|--|--|--|--|
|  |  |  |  |  |
| B2   16PCS   | C3   8PCS  | D2   3PCS  | D2   6PCS  |  |

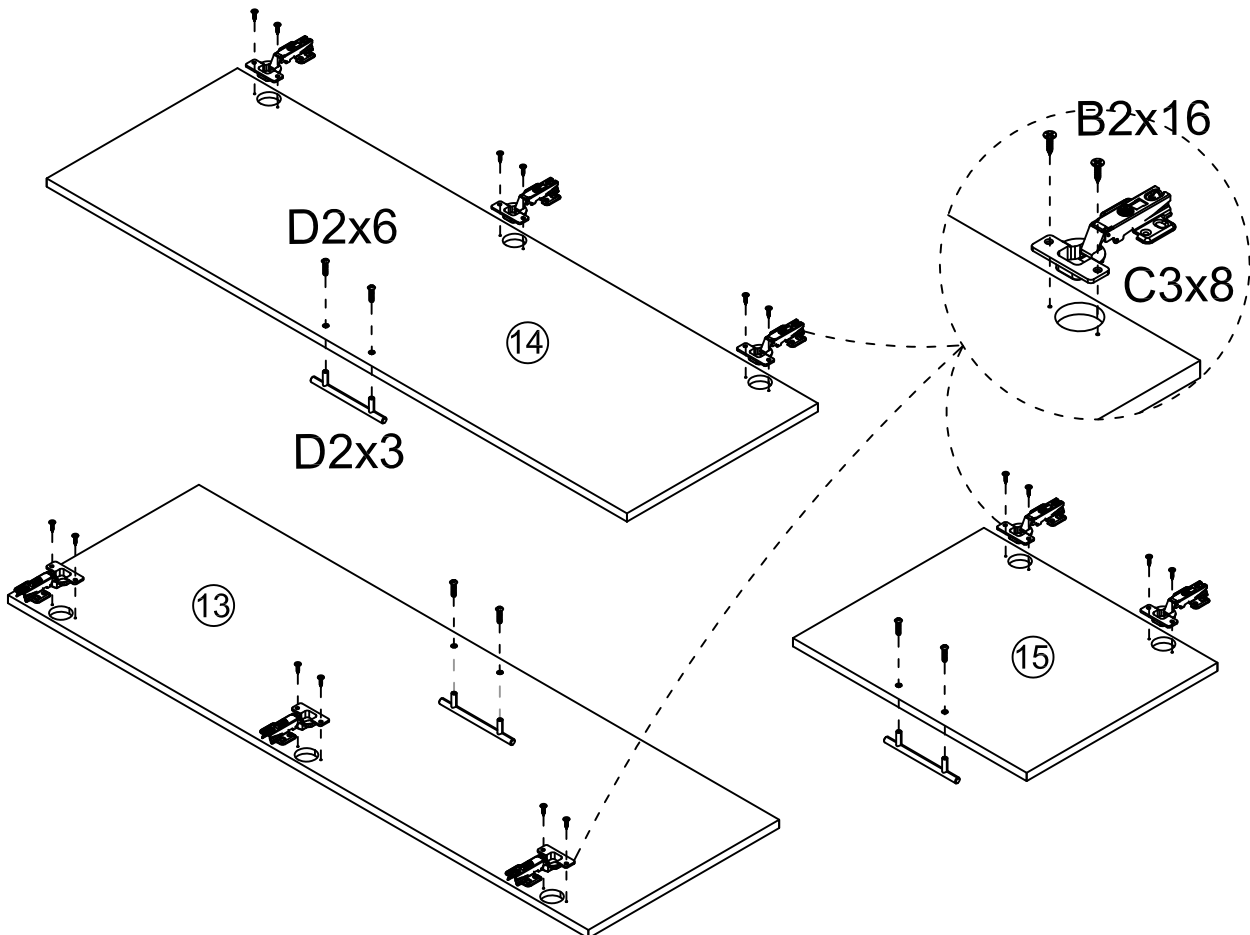

# Assemble

Step 24



B2 20PCS

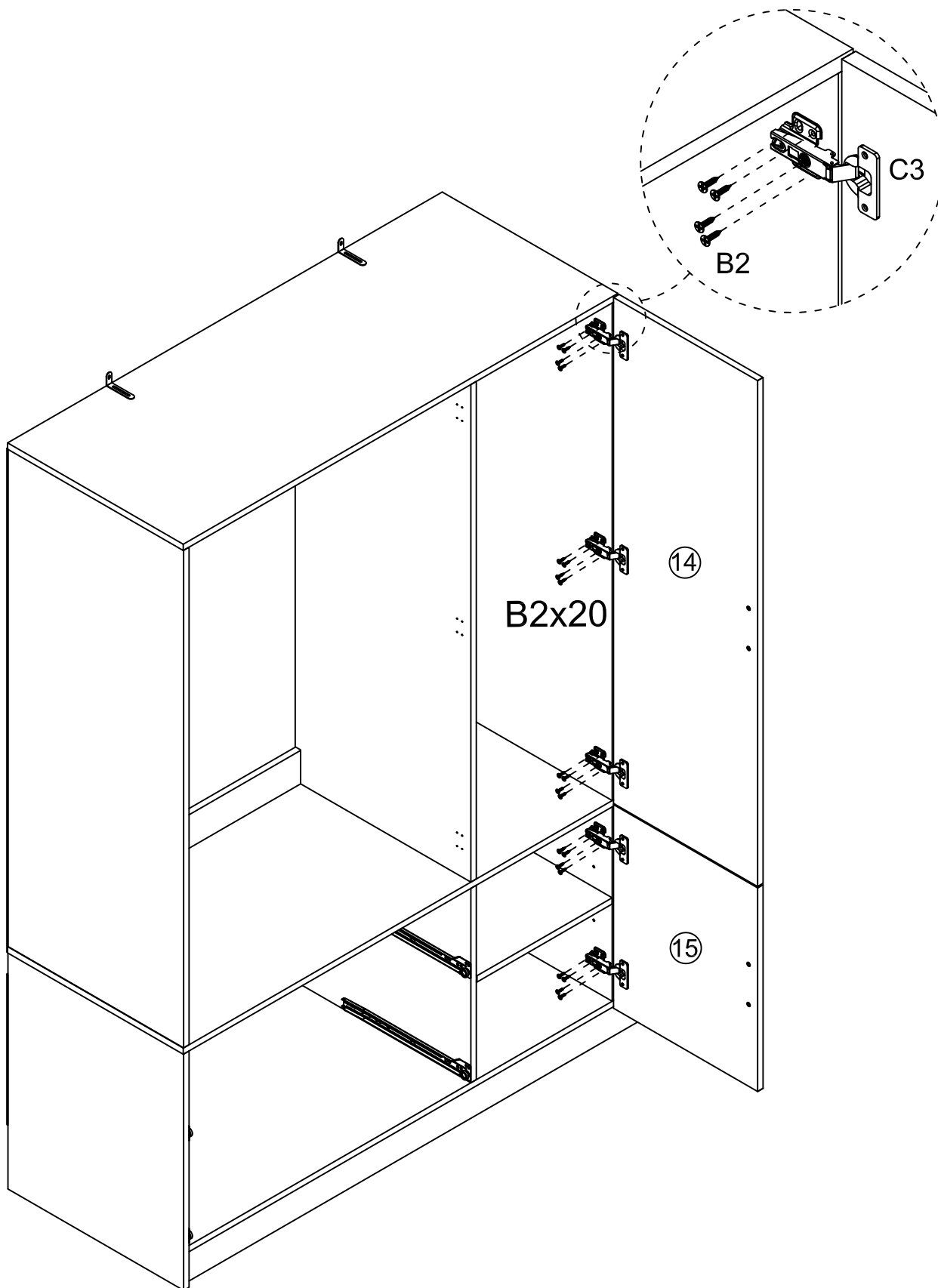
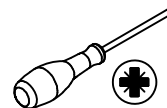

# Assemble

Step 25

|   |       |   |
|---|-------|---|
|  |       |  |
| B2  | 24PCS |  |

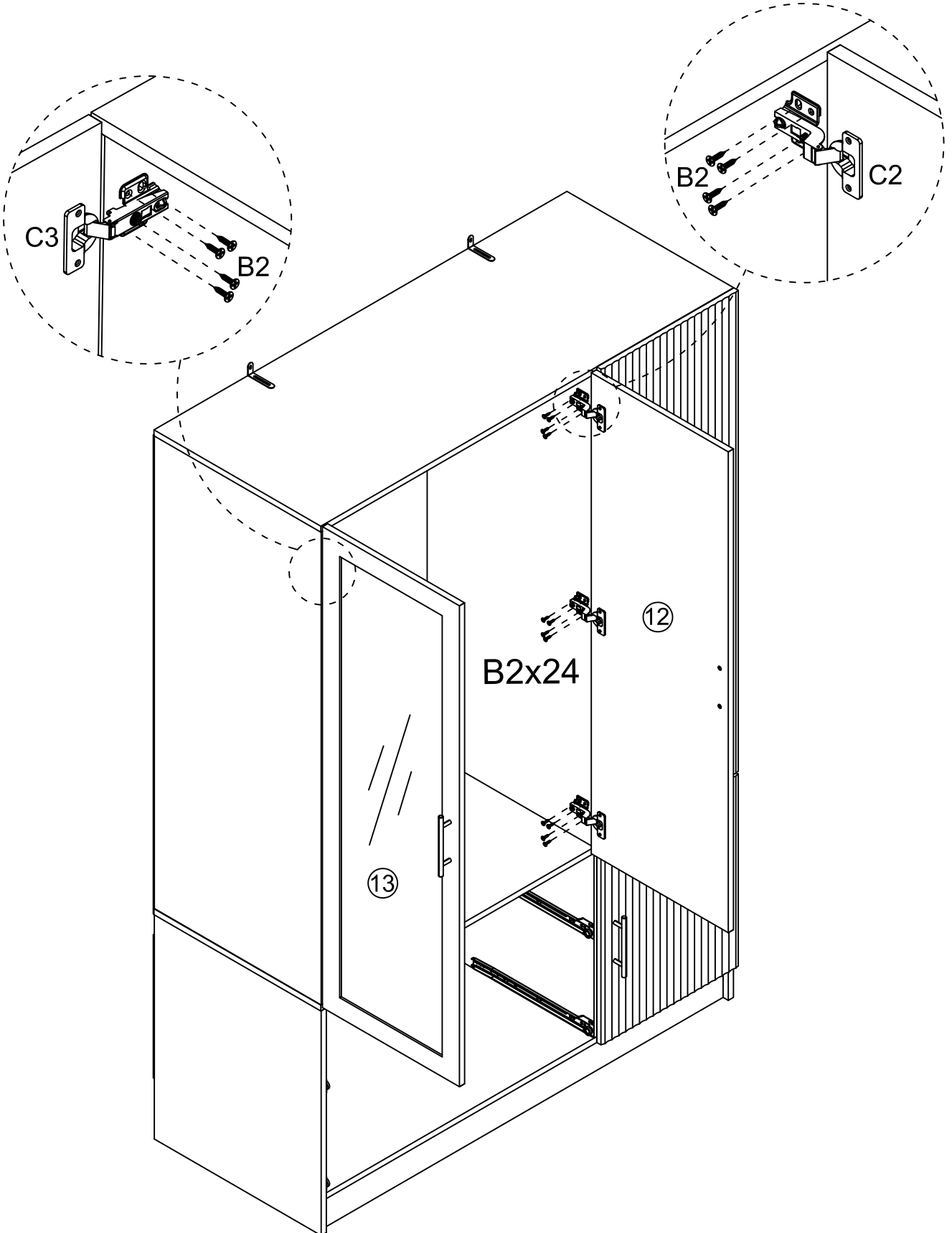

# Assemble

Step 26

|   |   |  |  |
|---|---|--|--|
|  |  |  |  |
| LED 1PC   | LED 2PCS  |  |  |

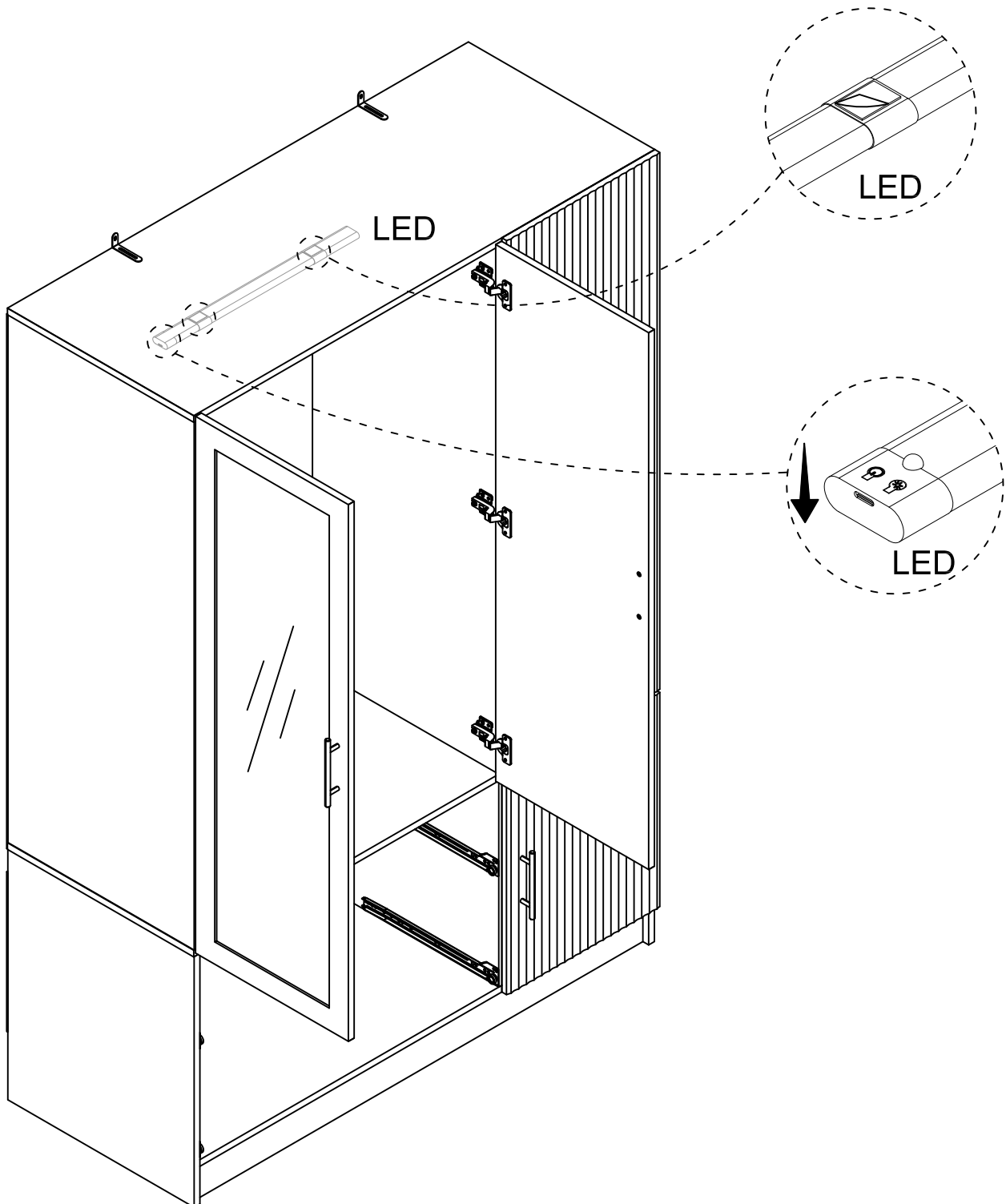



# Assemble

Step 27

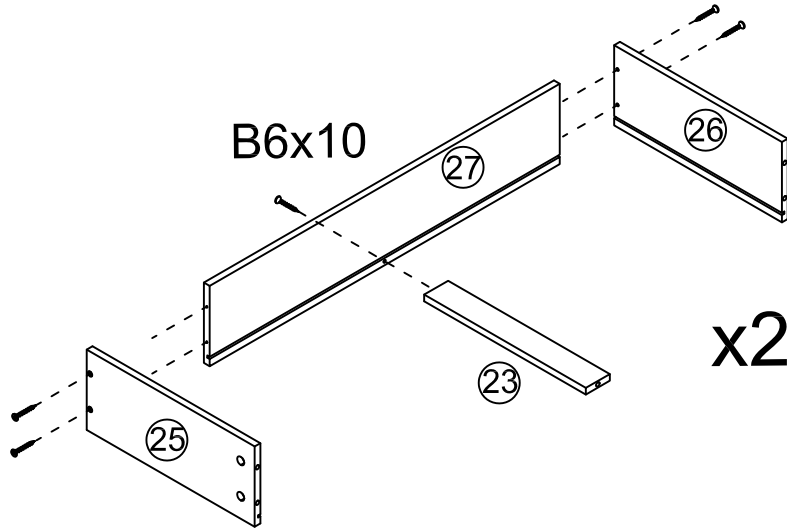
|   |       |  |  |   |  |
|---|-------|--|--|---|--|
|  |       |  |  |  |  |
| B6  | 10PCS |  |  |   |  |

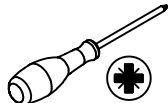

Step 28

|   |       |   |      |   |      |   |  |
|---|-------|---|------|---|------|---|--|
|  |       |  |      |  |      |  |  |
| A1  | 10PCS | D2  | 2PCS | D2  | 4PCS |   |  |

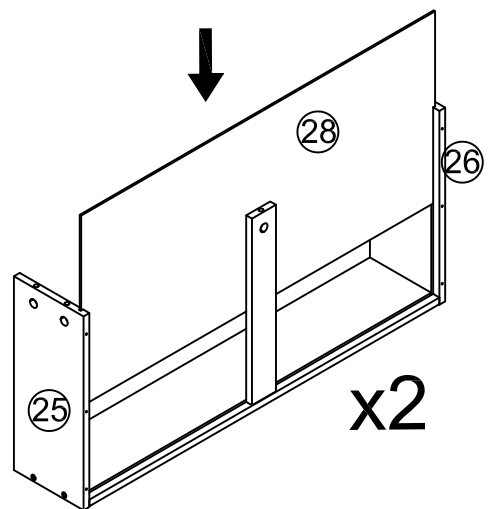
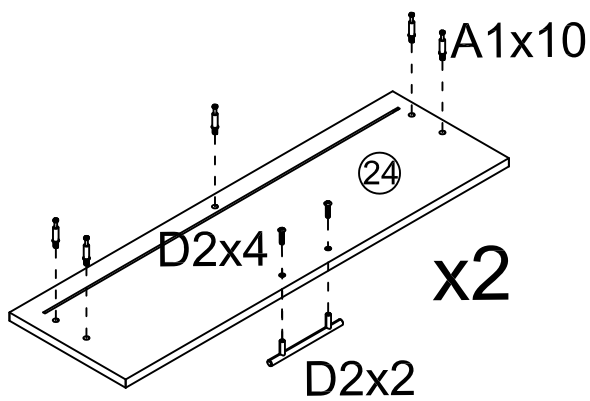
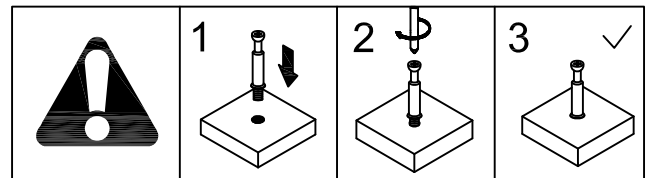



# Assemble

Step 29

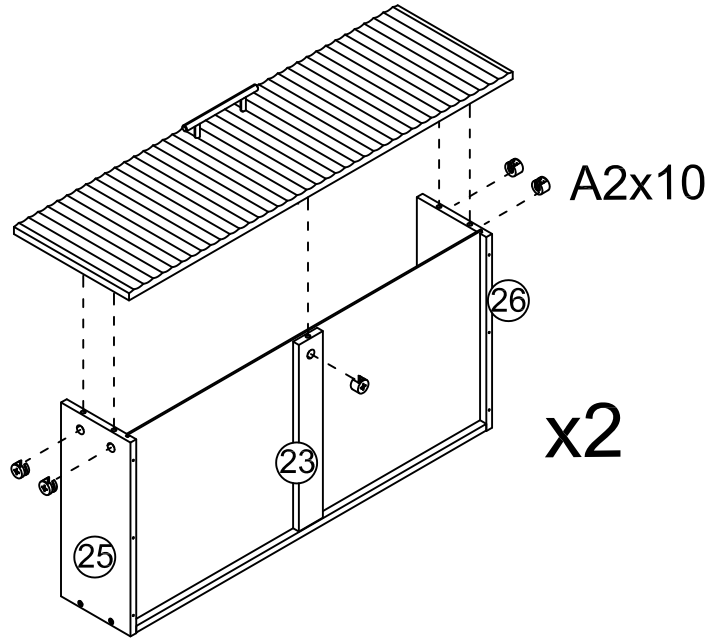
|   |       |  |  |   |
|---|-------|--|--|---|
|  |       |  |  |  |
| A2  | 10PCS |  |  |   |

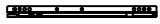

Step 30

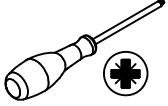
|   |   |   |   |      |    |
|---|---|---|---|------|----|
|  |  |  |  |      |    |
| DR  | 2PCS  | DL  |   | 2PCS | B1 |

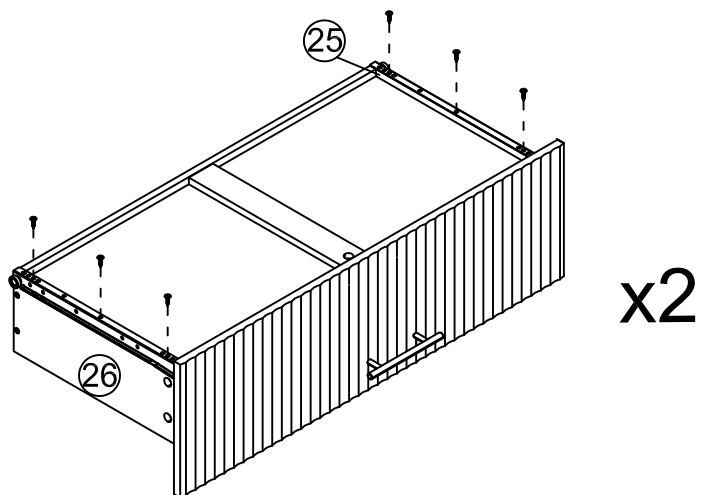
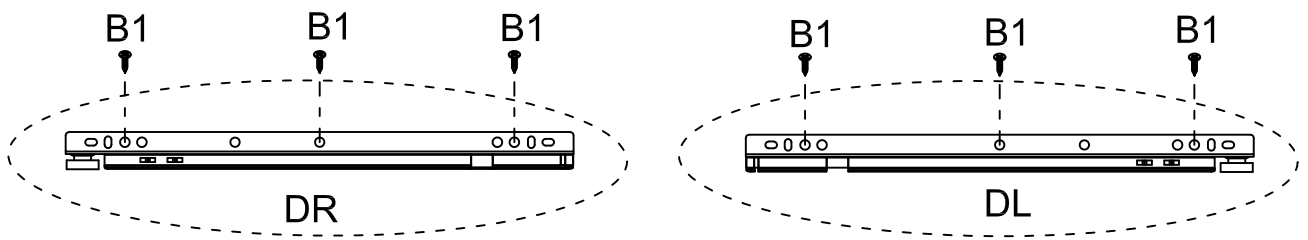

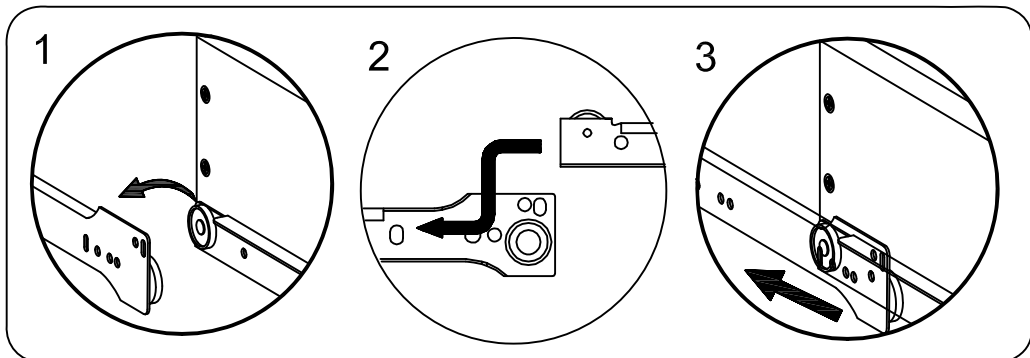
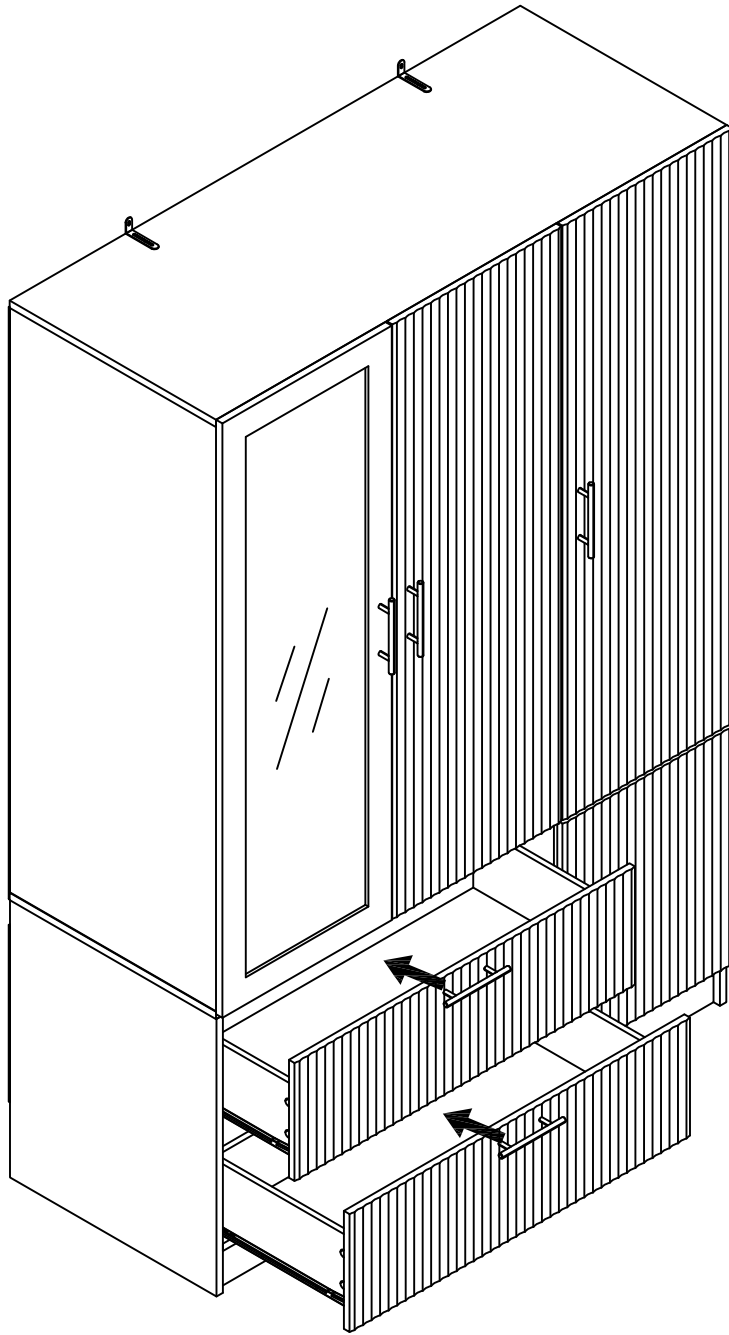

# Assemble

Step 31



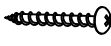

# Assemble

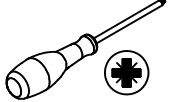
Step 32

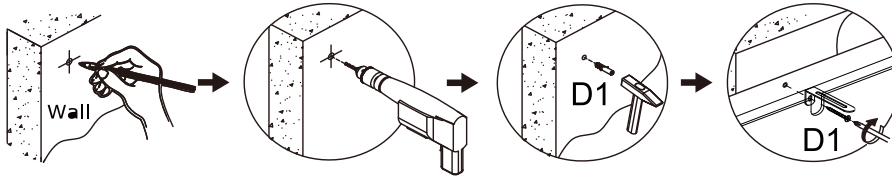
|   |      |   |      |   |       |   |
|---|------|---|------|---|-------|---|
|  |      |  |      |  |       |  |
| D1  | 2PCS | D1  | 2PCS | C6  | 20PCS |   |

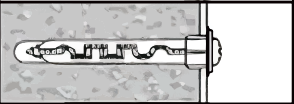
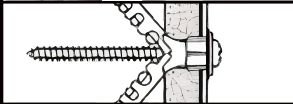

| A solid wall  | B cavity wall   | C solid wood   |
|---|---|--|
|  |  |  |
| Φ6mm<br>(1/4°)  | Φ6mm<br>(1/4°)  | Φ3mm<br>(1/8°)   |

- ⚠ Warning:** If you overturn the furniture, it may cause serious or fatal crushing injuries. We have a wall connection device attached, please use it to hold the furniture following these instructions.
1. . Mark the corresponding hole positions where you want to place the furnitur
  2. . Use a impact drill to drill holes and pay attention to avoid wires and water pipe
  3. . Knock the expansion pipes into the wall hole
  4. . Place the furniture in the corresponding position and tighten the waconnection device with screws.

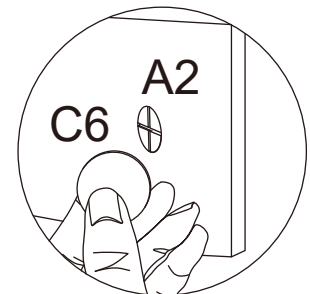
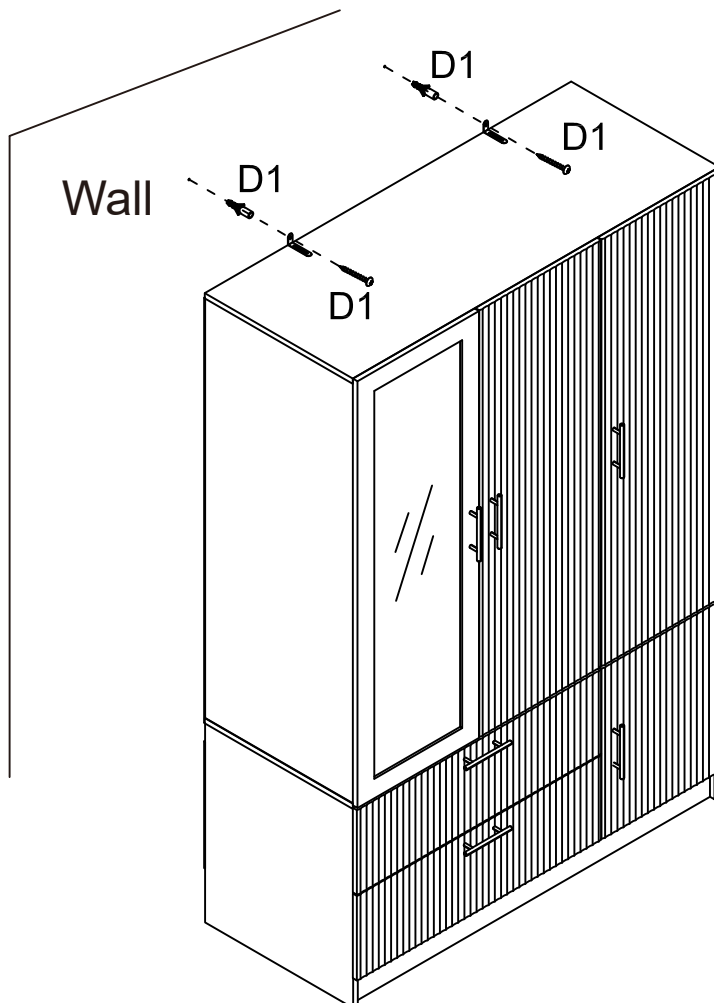

Use the stickers I to cover the holes

# HINGE INSTRUCTION

**a:**

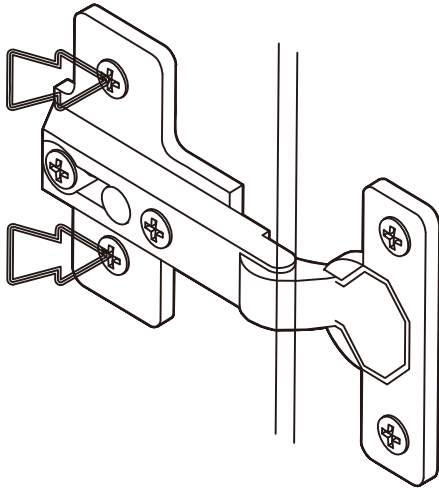

SCREW IN AND OUT HERE,  
IT CAN ADJUST THE DOOR  
UP AND DOWN

**b:**

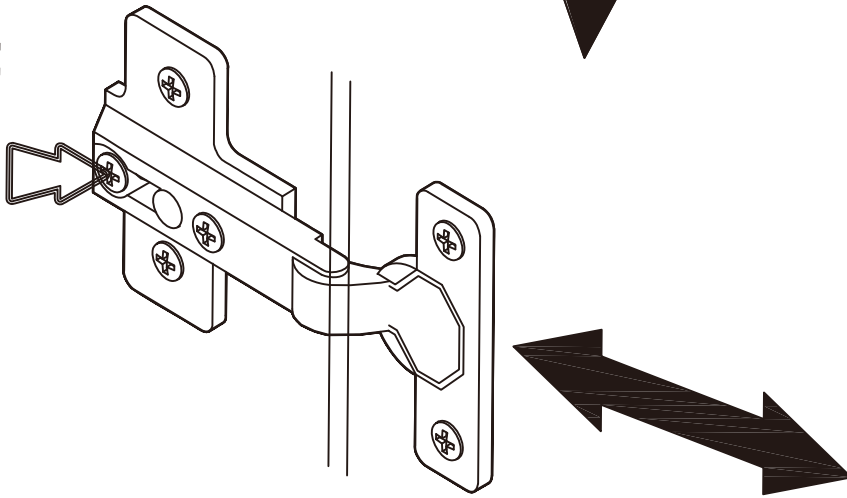

SCREW IN AND OUT HERE, IT CAN  
ADJUST THE DOOR FRONT AND BACK

**c:**

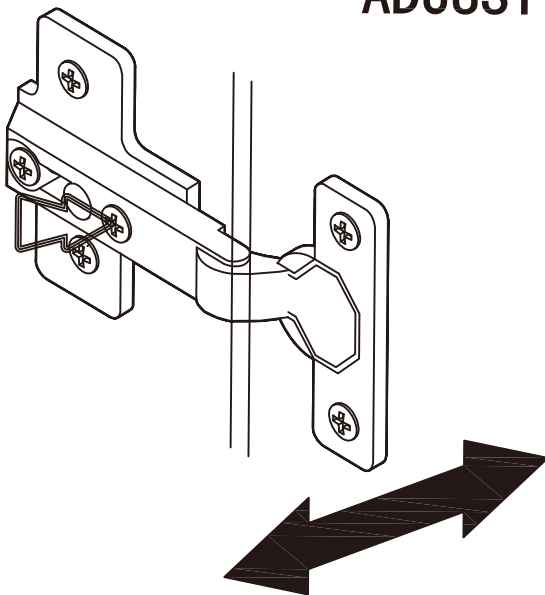

SCREW IN AND OUT HERE, IT CAN  
ADJUST THE DOOR LEFT AND RIGHT