

## INSTALLATION INSTRUCTIONS

MODEL B1015

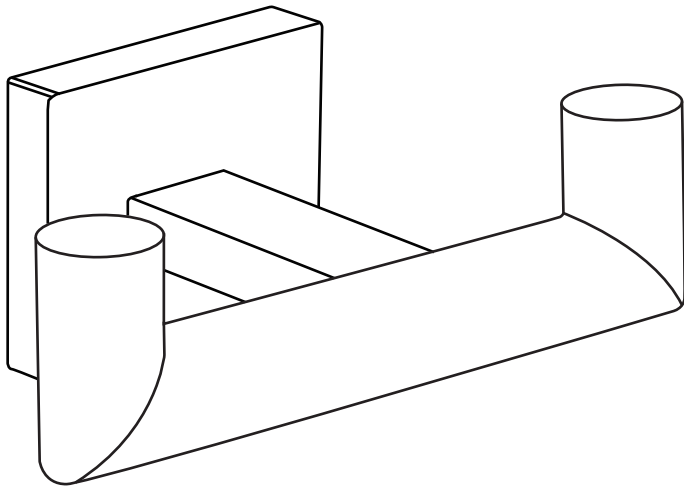

## Recommended Tools



Pencil



Electric drill



Hammer

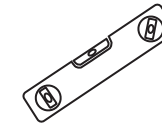

Level

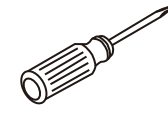

Philips screwdriver

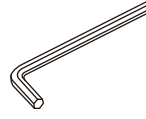

Hexagon wrench

## INSTALLATION

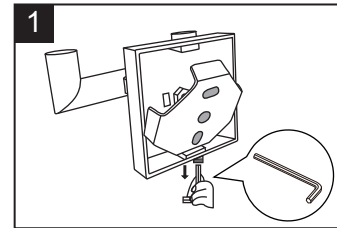

Use the Hexagon wrench to remove the hex screw first. Then take out the bracket from the back of the holder.

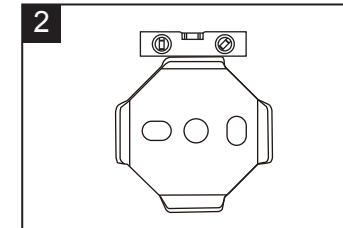

Choose the installation position and put the level on the bracket to make sure its horizontal.

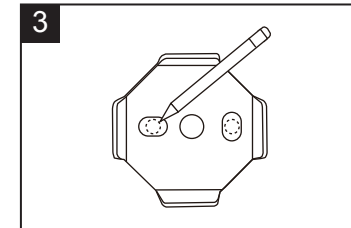

Use pencil to draw the position of the screw hole in the bracket.



**Drill Hole Size: 7/32"**

Measure the center distance of the hole on the wall first, then drill the hole.

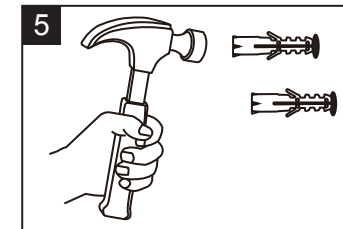

Hammer the anchor into the wall.

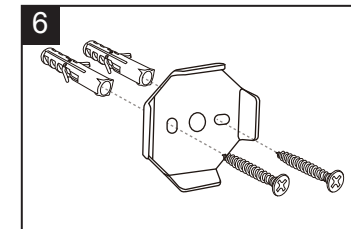

Place the bracket on the wall hole and insert the screw into the hole, then fasten with the Phillips screwdriver.

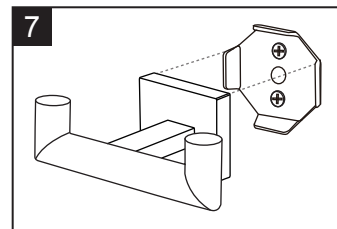

Put the hardware body onto the base bracket.

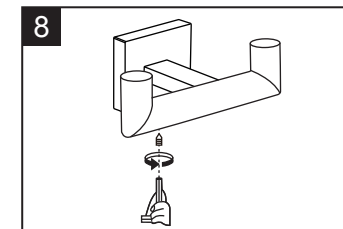

Fasten the hex screw with the hex wrench.



[support@kokosirihome.com](mailto:support@kokosirihome.com)

Installation Support  
Missing Parts  
Damaged Product

Thank you for selecting our product. To ensure that your installation proceeds smoothly, read these instructions carefully before you begin. Also, review the recommended tools and materials section. Carefully unpack and examine your new plumbing fixture.

**CAUTION**

Please call professional if you are uncertain about installing this product.



**NOTE** : If you return the package, please put hardware, screws and installation guide back into the package. Thanks!  
Please feel free contact us via e-mail if installation hardware **NOT** included.



YouTube

[www.kokosirihome.com](http://www.kokosirihome.com)

