

B5051-Q

PARTS

#1 x 1pc

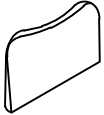

Headboard

#2 x 1pc

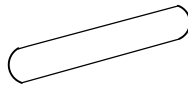

Footboard

#3 x 2pcs

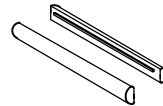

Side Rail

#4 x 2pcs

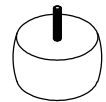

Leg

#5 x 4pcs



Support Leg

#6 x 1pc

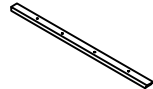

Support Rail

#7 x 1pc

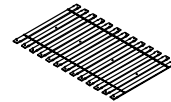

Slat

#8 x 2pcs



HB LEG

#9 x 4pcs



Connection strap
(L/R)

HARDWARE

#A x 16pcs

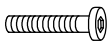

Bolt Ø5/16" x 1-1/2"

#B x 6pcs



Threaded Stud
Ø5/16" x 3-1/4"

#C x 6pcs



Hex Nut Ø5/16"

#D x 22pcs



Flat Washer Ø1/4"x19mm

#E x 22pcs



Lock Washer Ø5/16"

#F x 1pc

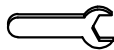

Wrench 12mm

#G x 26pcs

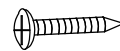

Screw #8x1-1/2"











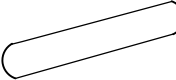



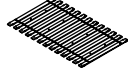

#H x 1pc



Allen Wrench M5

B5051-Q

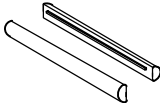
B5051-Q packed in 2 cases

Carton	Desc.	Part	Q.TY	Hardware
B5051-Q-1	Headboard	#1	 1pc	
	Footboard	#2	 1pc	#A x 16pcs  Bolt Ø5/16" x 1-1/2"
	Leg	#4	 2pcs	#B x 6pcs  Threaded Stud Ø5/16" x 3-1/4"
	Support leg	#5	 4pcs	#C x 6pcs  Hex Nut Ø5/16"
	Slat	#7	 1pc	#D x 22pcs  Flat Washer Ø1/4"x19mm
	HB LEG	#8	 2pcs	#E x 22pcs  Lock Washer Ø5/16"
	Connection strap	#9	 4pcs	#F x 1pc  Wrench 12mm
	Support Rail	#6	 1pc	#G x 26pcs  Screw #8x1-1/2"
	Side Rail	#3	 2pcs	#H x 1pc  Allen Wrench M5

ASSEMBLY INSTRUCTIONS

STEP 1

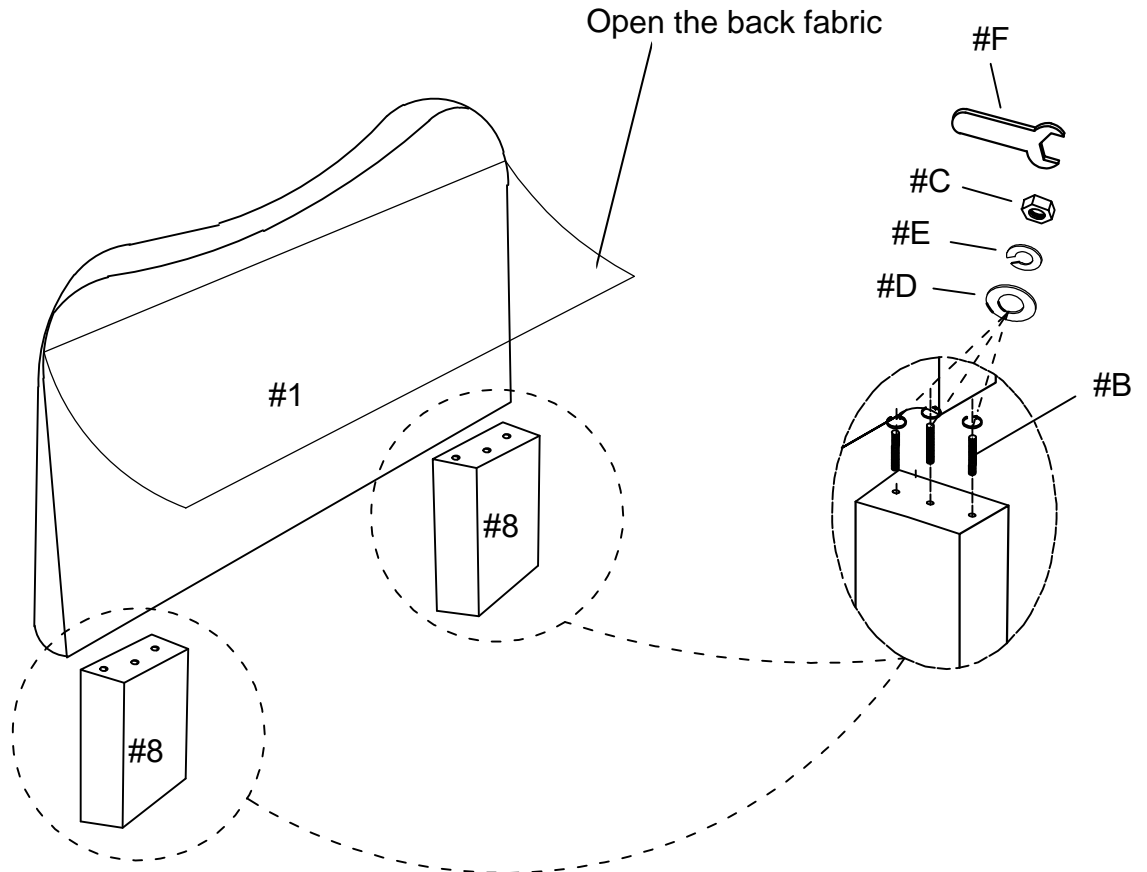

STEP 2

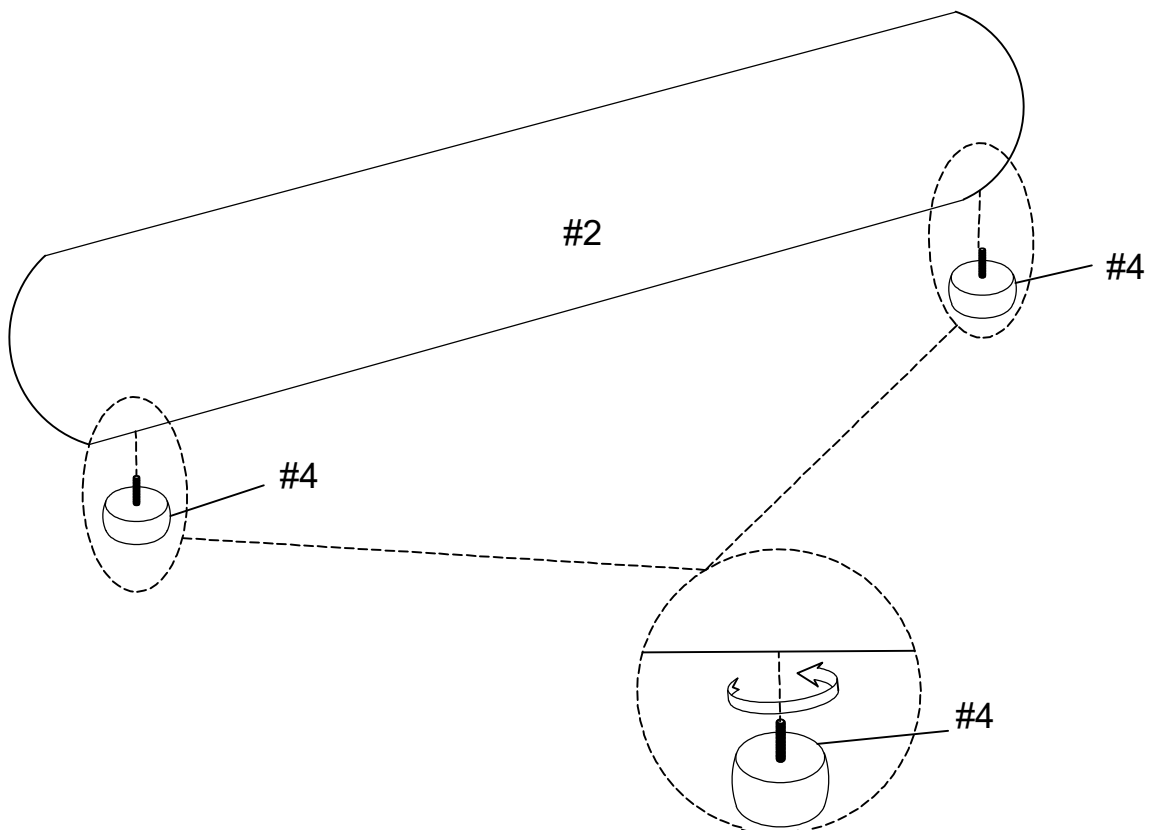

ASSEMBLY INSTRUCTIONS

STEP 3

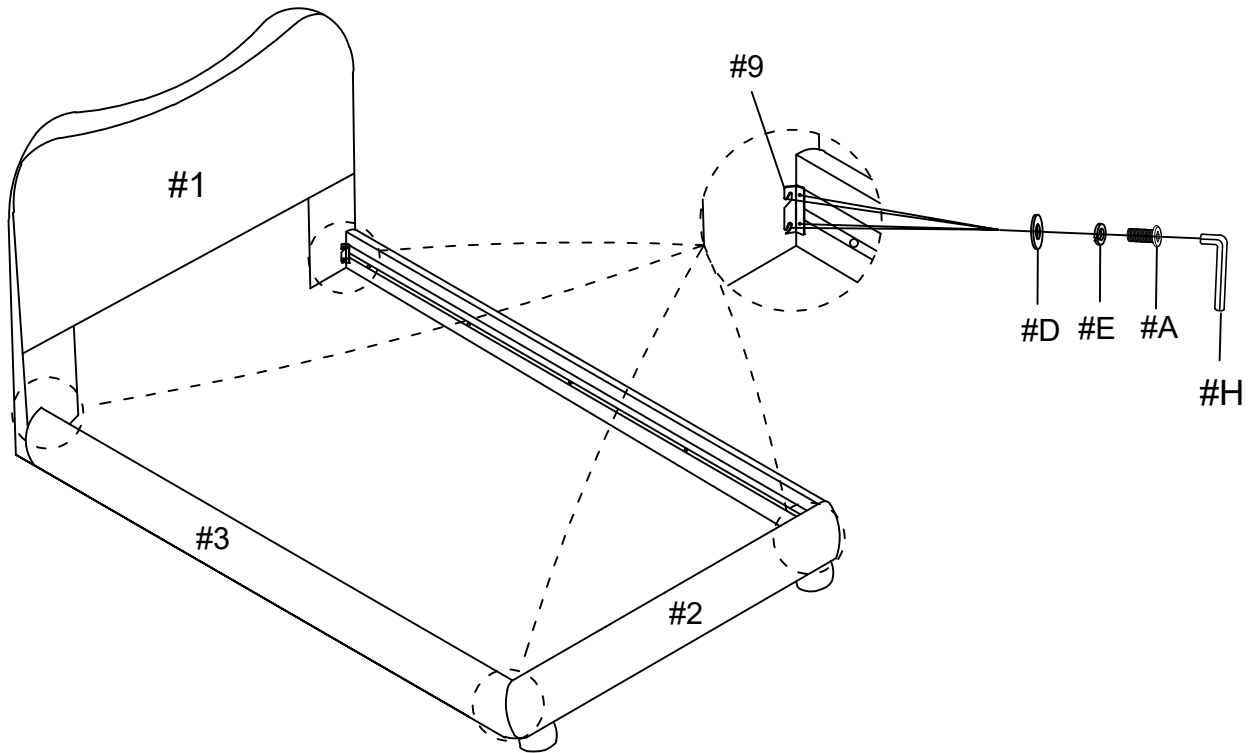

STEP 4

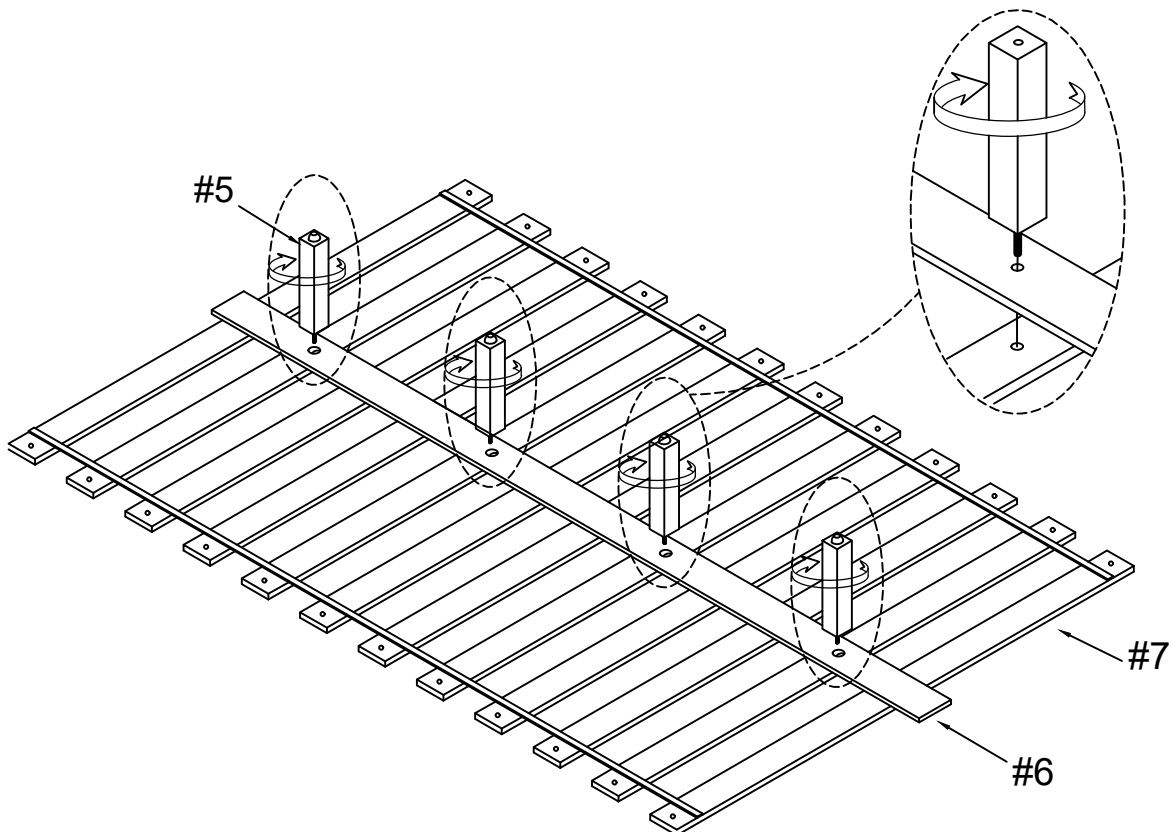

ASSEMBLY INSTRUCTIONS

STEP 5

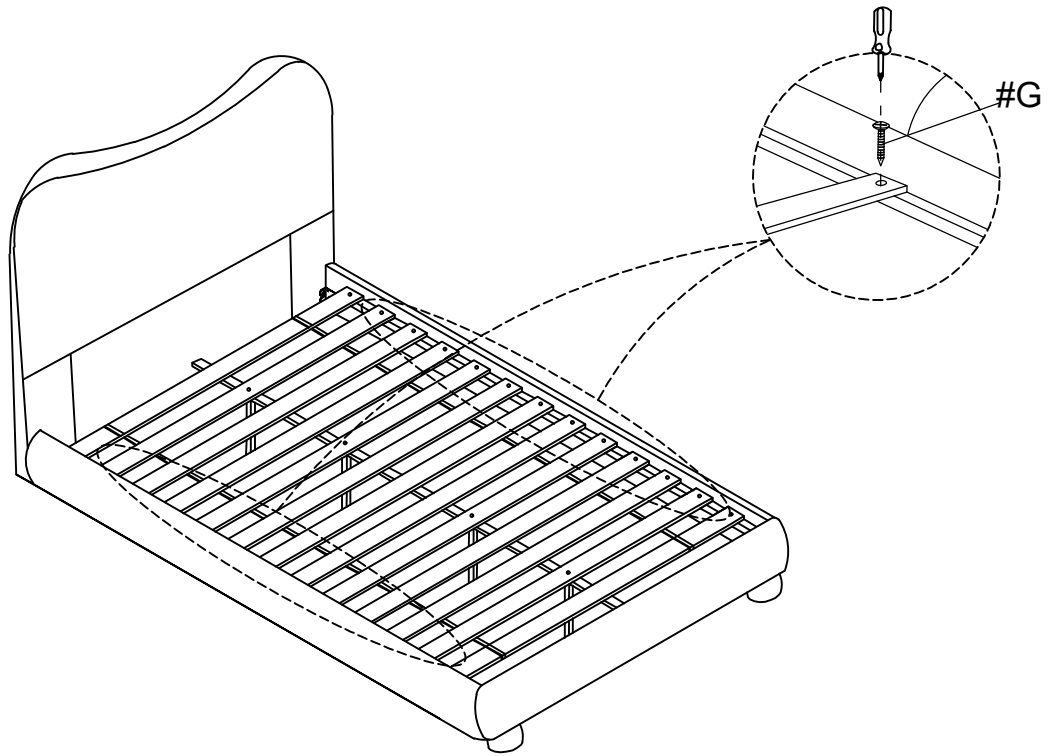

STEP 6

