

STAINLESS STEEL VANITY

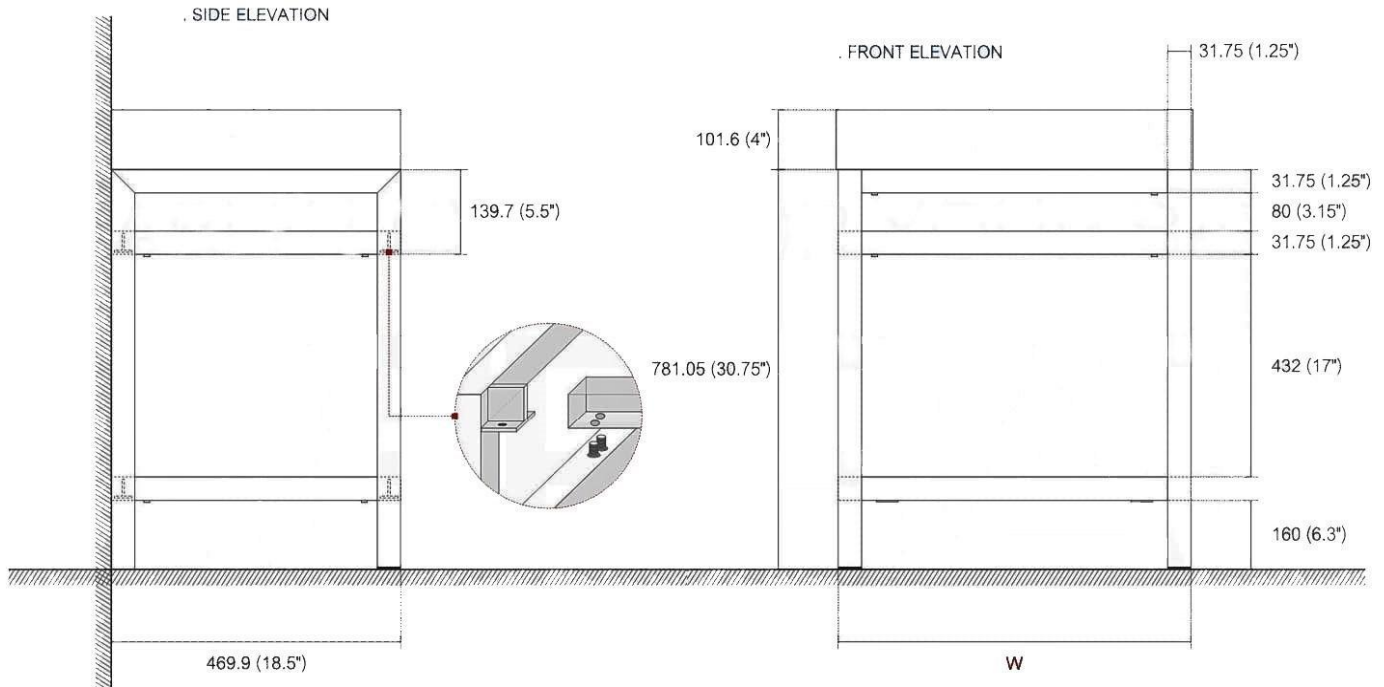

Dimensions inches:		
width	depth	height

15.75	18.5	30.75
23.5	18.5	30.75
29.25	18.5	30.75
35.5	18.5	30.75
39.25	18.5	30.75
47	18.5	30.75
58.75	18.5	30.75
58.75	18.5	30.75

Dimensions mm:		
width	depth	height

400	469.9	781.05
597	469.9	781.05
743	469.9	781.05
902	469.9	781.05
997	469.9	781.05
1194	469.9	781.05
1492	469.9	781.05
1492	469.9	781.05

NOTE: DIMENSIONS AND TECHNICAL DETAILS ARE SUBJECT TO CHANGE WITHOUT NOTICE

SINK

NOTE: DIMENSIONS AND TECHNICAL DETAILS ARE SUBJECT TO CHANGE WITHOUT NOTICE

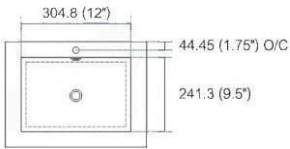

Thickness: 9.53 (0.38")

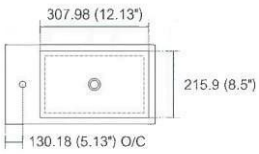

Thickness: 9.53 (0.38")

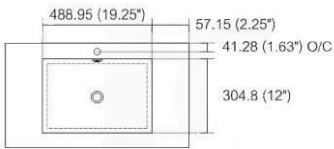

Thickness: 9.53 (0.38")

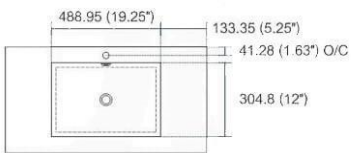

Thickness: 9.53 (0.38")

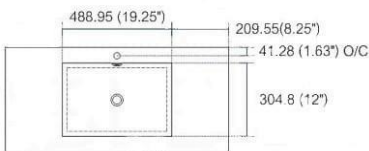

Thickness: 9.53 (0.38")

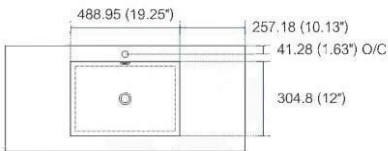

Thickness: 9.53 (0.38")

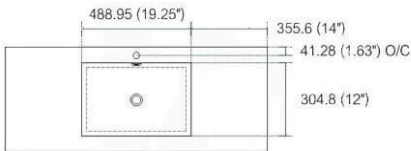

Thickness: 9.53 (0.38")

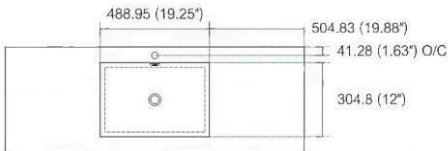

Thickness: 9.53 (0.38")

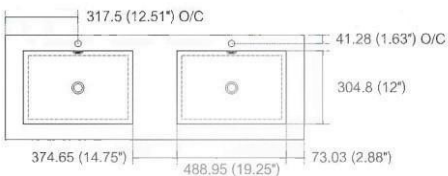

Thickness: 9.53 (0.38")

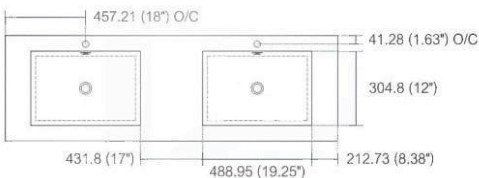

Thickness: 9.53 (0.38")

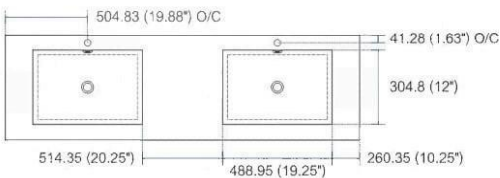

Thickness: 9.53 (0.38")

Dimensions:	width	length	height	depth
inches	16.0"	16.0"	4.0"	3.38"
mm	406.4	406.4	101.6	85.73

Dimensions:	width	length	height	depth
inches	18.0"	10.25"	4.0"	3.38"
mm	457.2	257.18	101.6	85.73

Dimensions:	width	length	height	depth
inches	23.63"	18.5"	4.0"	4.0"
mm	600.08	469.9	101.6	101.6

Dimensions:	width	length	height	depth
inches	29.5"	18.5"	4.0"	4.0"
mm	749.3	469.9	101.6	101.6

Dimensions:	width	length	height	depth
inches	35.75"	18.5"	4.0"	4.0"
mm	908.05	469.9	101.6	101.6

Dimensions:	width	length	height	depth
inches	39.5"	18.5"	4.0"	4.0"
mm	1003.3	469.9	101.6	101.6

Dimensions:	width	length	height	depth
inches	47.25"	18.5"	4.0"	4.0"
mm	1200.15	469.9	101.6	101.6

Dimensions:	width	length	height	depth
inches	59"	18.5"	4.0"	4.0"
mm	1498.6	469.9	101.6	101.6

Dimensions:	width	length	height	depth
inches	59"	18.5"	4.0"	3.75"
mm	1498.6	469.9	101.6	95.25

Dimensions:	width	length	height	depth
inches	71.63"	18.5"	4.0"	4.0"
mm	1819.28	469.9	101.6	101.6

Dimensions:	width	length	height	depth
inches	79"	18.5"	4.0"	4.0"
mm	2006.6	469.9	101.6	101.6

INSTALLATION GUIDE

Tools Required for Assembly

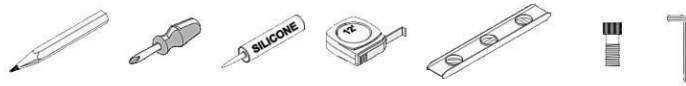

Vanity Installation



1. Remove the plastic protective film.
2. Install all the Parts of the Cabinet.
3. Add a dap of silicone to the corners of the TOP of the Cabinet.
4. Gently position and align Counter top Sink onto Vanity.

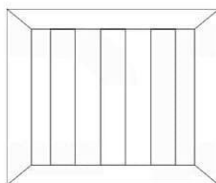
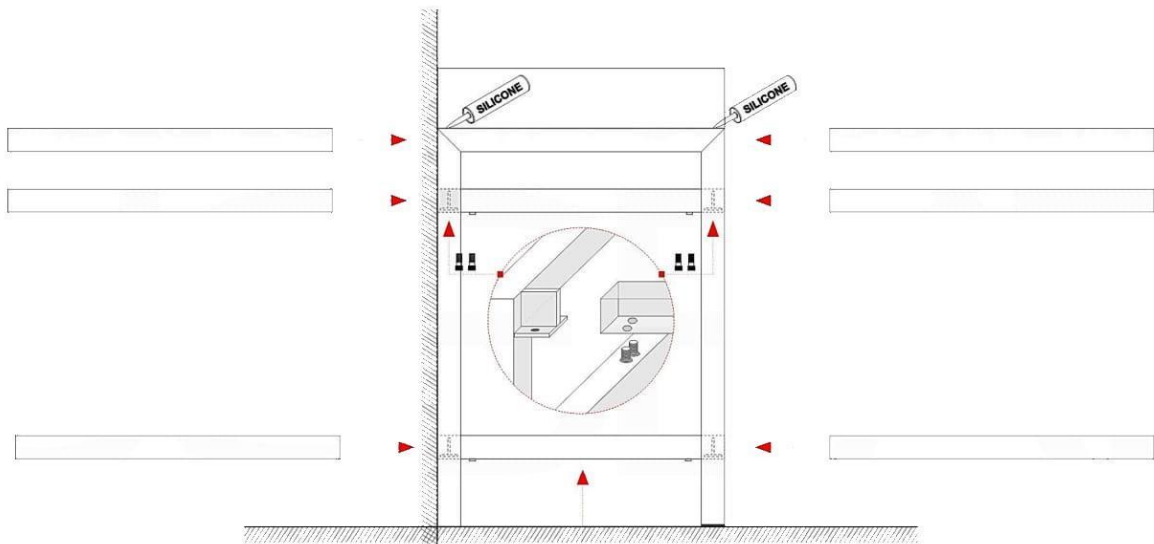

Pop-Up / P-trap Installation Instructions INSTALLATION GUIDE

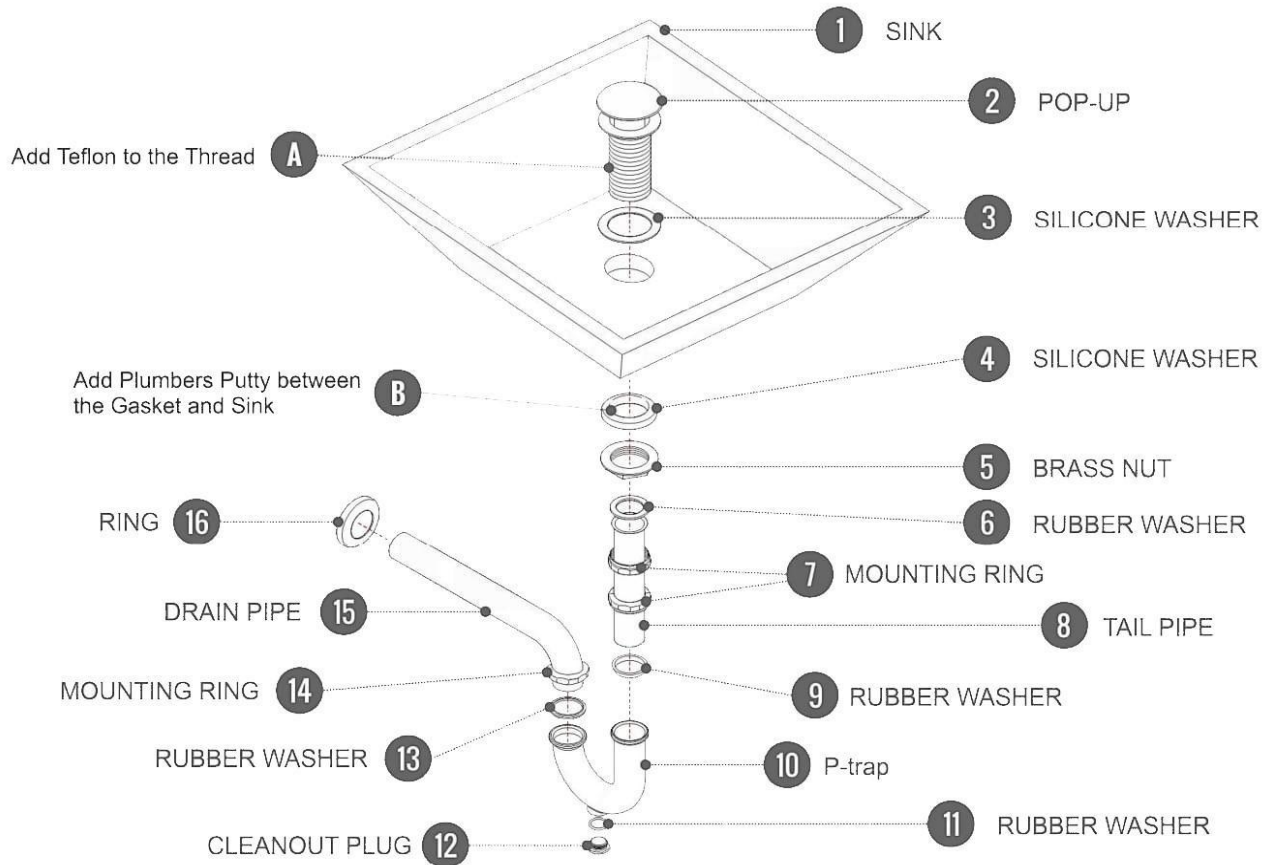

FOR SINKS WITHOUT OVERFLOW

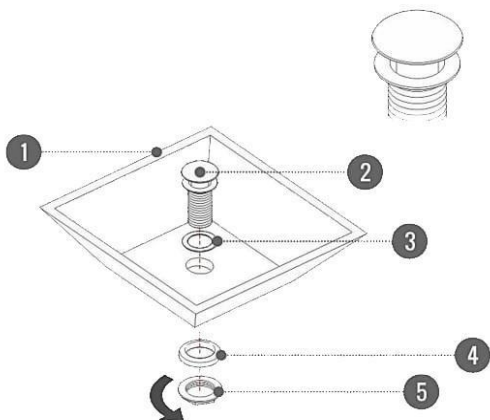

OR

FOR SINKS WITHOUT OVERFLOW

