

ASSEMBLY INSTRUCTIONS

DOUBLE ROOF BED

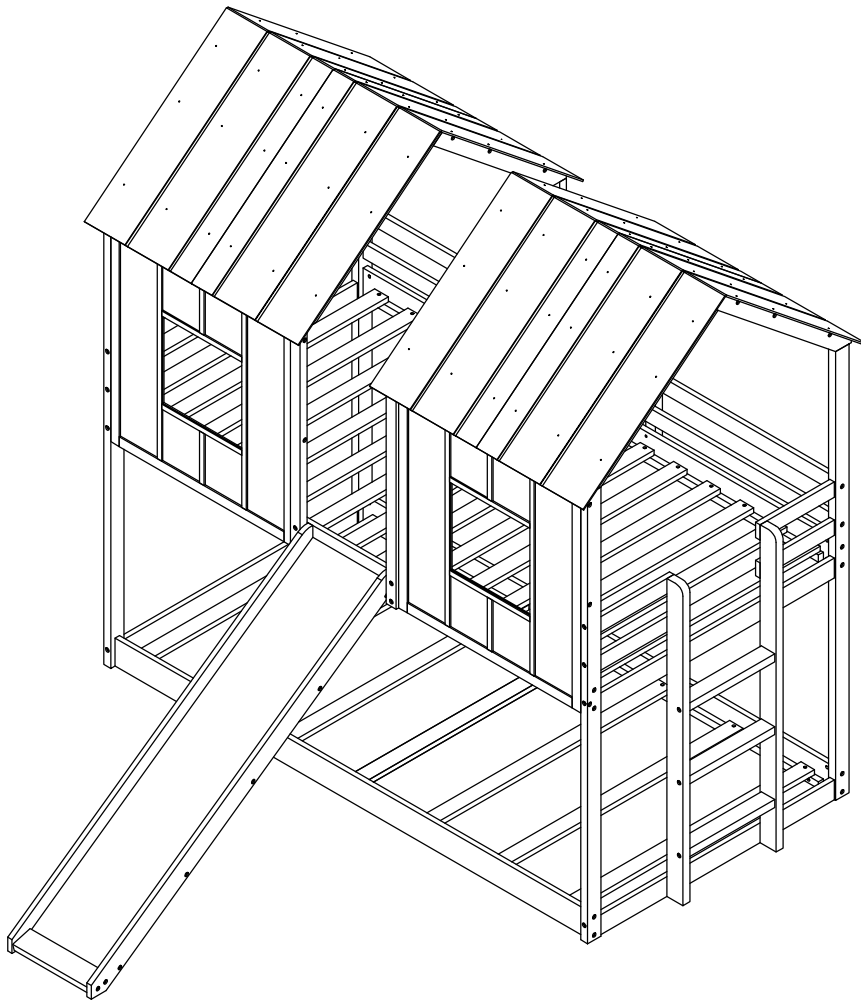

★ Replacement Parts:

- Replacement Parts, including additional guardrails, may be obtained from any of our dealers
- Follow the information on the warnings appearing on the upper bunk bed end structure and on the carton. Do not remove warning label from bed.
- We recommend assembling your loft bed on this shipping carton to protect your floor or carpet.
- Always use the recommended size mattresses or mattress supports, or both, to help prevent the likelihood of entrapment or falls.
- Keep these instructions for future reference.
- This bed is designed to use a twin mattress 37 1/2" - 38 1/2" wide x 74" to 75" long with the total thickness not exceeding 6" for upper bunk.
Do not use mattress without the proper slat system and proper attachments described in the instruction.
- Prohibit more than one person on upper bunk.
- Surface of the mattress must be at least 5". (127 mm) below the upper edge of guardrails.
- Do not allow children under 6 years of age to use the upper bunk.
- Periodically check and ensure that the guardrail, ladder, and other components are in their proper position, free from damage, and that all connectors are tight.
- Do not allow horseplay on or under the bed and prohibit jumping on the bed.
- Always use the ladder for entering and leaving the upper bunk.
- Do not use substitute parts. Contact the manufacturer or dealer for replacement parts.
- Be certain all staples are out of the box before beginning assembly on the shipping carton.
- Use of a night light may provide added safety precaution for a child using the upper bunk.
- Always use guardrails on both long sides of the upper bunk. If the loft bed will be placed next to the wall, the guardrail that runs the full length of the bed should be placed against the wall to prevent entrapment between the bed and the wall.
- The use of water or sleep flotation mattress is prohibited.
- **STRANGULATION HAZARD** - Never attach or hang items to any part of the loft bed that are not designed for use with the bed; for example, but not limited to, hook, belts, and jump ropes.
Keep these instructions for future reference.



SAFETY WARNINGS







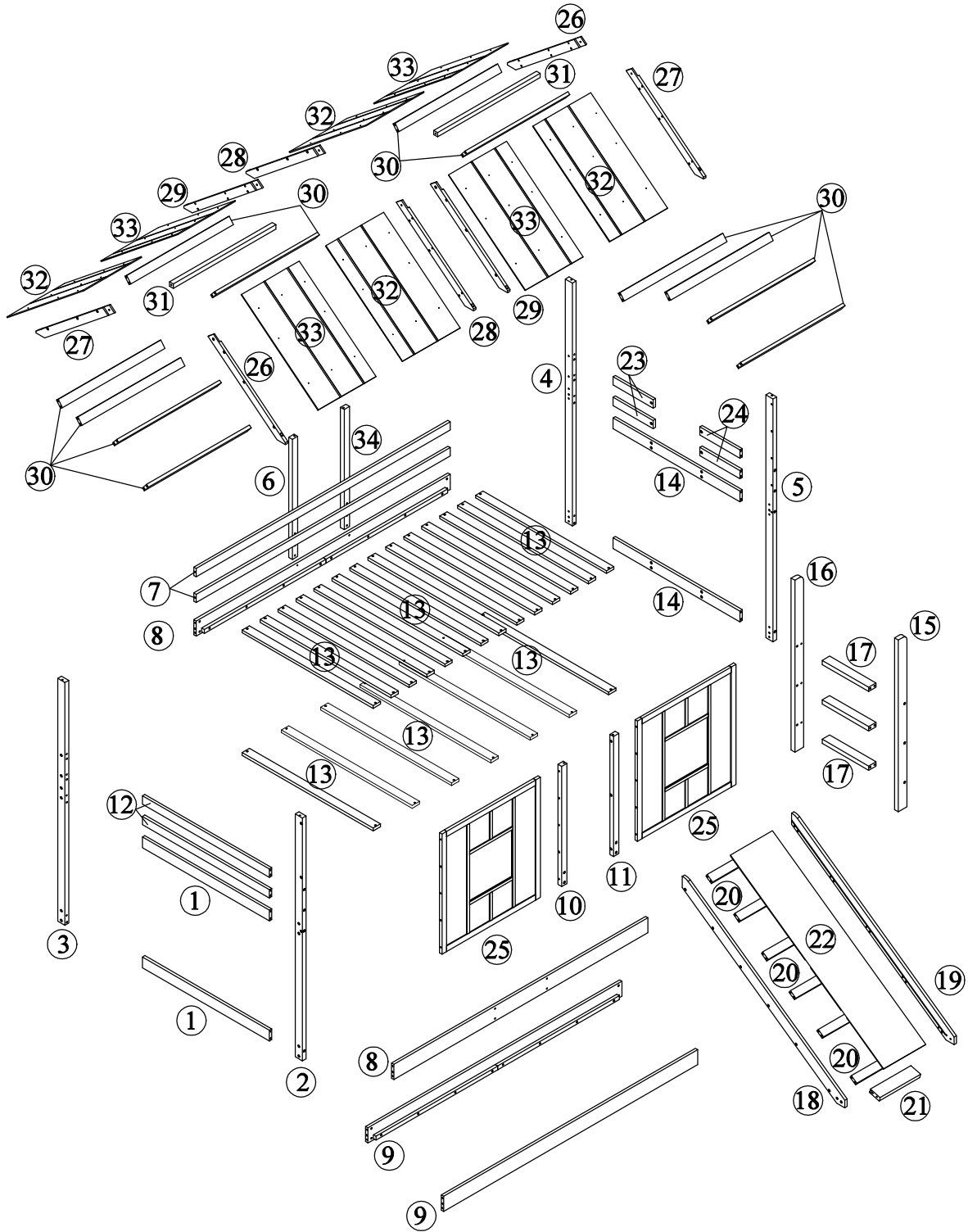



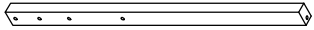
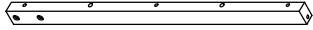
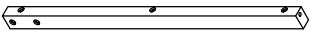
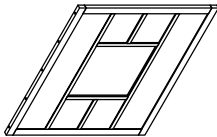
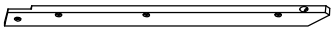

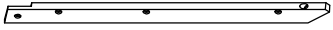

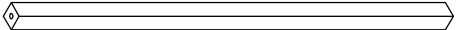
1. **At the beginning :**
 - Tighten all hardware.
 - Check metal parts for rust. If found, sand and repaint using a non-lead-based paint meeting the requirements of 16 CFR 1303.
 - Check all wood members for deterioration and splinters. Sand down splinters and replace deteriorating wood members.
 - Rake and check depth of loose fill protective surfacing materials to prevent compaction and to maintain appropriate depth. Replace as necessary.
2. **Twice a month**
 - Tighten all hardware.
 - Rake and check depth of loose fill protective surfacing materials to prevent compaction and to maintain appropriate depth. Replace as necessary.
3. **Owners shall be responsible for maintaining the legibility of the warning labels.**
4. **Disposal Instructions-**
 - There shall be instructions advising the owner to disassemble and dispose of the playground equipment in such a way that no unreasonable hazards will exist at the time the playground equipment is discarded.
5. **The instructions shall also include the information found in Section 4 of the United States Consumer Product Safety Commission's (USCPSC) Outdoor Home Playground Safety Handbook or specific surfacing guidelines for the product consistent with the USCPSC Handbook. A copy of this section may be found in Appendix X2.**
6. **Observing the following statements and warnings reduces the likelihood of serious or fatal injury.**
7. **Specifying the number and weight of occupants that may safely use the equipment singly or simultaneously,**
8. **Recommending on-site adult supervision for children of all ages,**
9. **Warning the owner to instruct children not to use the equipment in a manner other than intended,**
10. **Warning the owner to instruct children not to get off equipment while it is in motion,**
11. **Warning the owner not to allow children to wear inappropriate items, such as but not limited to, loose fitting clothing, hood and neck drawstrings, scarves, cord-connected items, capes and ponchos. These items can cause death by strangulation.**
12. **Warning the owner to instruct children not to climb when the equipment is wet.**
13. **Warning the owner to instruct children not to attach items to the playground equipment that are not specifically designed for use with the equipment, such as, but not limited to, jump ropes, clothesline, pet leashes, cables and chain as they may cause a strangulation hazard**
14. **Warning the owner to instruct children to remove their bike or other sports helmet before playing on the playground equipment.**
15. **Warning the owner to dress children with well-fitting and full foot enclosing footwear. Examples of inappropriate footwear are clogs, flip flops, and sandals.**
16. **Place the equipment on level ground, not less than 6 ft (1.8 m) from any structure or obstruction such as a fence, garage, house, overhanging branches, laundry lines, or electrical wires**
17. **Do not install home playground equipment over concrete, asphalt, packed earth, grass, carpet, or any other hard surface. A fall onto a hard surface can result in serious injury or death to the equipment user**
18. **To prevent serious injury, cautionary statements shall be included which warn that children must not use the equipment until properly installed.**
19. **Advising the owner to tighten the nuts on bolts flush to the tube (or member) and that caps which go over the exposed bolts shall be put on snug to the nut.**

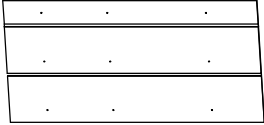
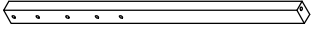
Detail View - DOUBLE ROOF BED

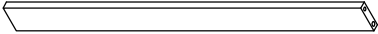
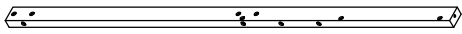
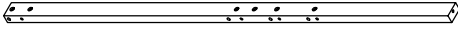
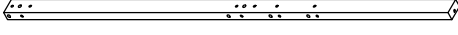
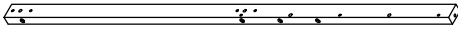

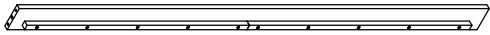
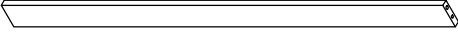
Identifying the Hardware-Identify the hardware using the illustrations below.

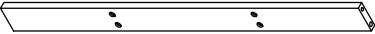
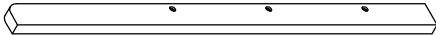
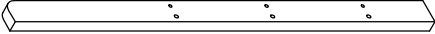
<p>6</p>  <p>Rear center column - 1pc</p>	<p>10</p>  <p>Front center column - 1pc</p>
<p>11</p>  <p>Front center column - 1pc</p>	<p>25</p>  <p>Front frame - 2pcs</p>
<p>26</p>  <p>Roof connecting bar - 2pcs</p>	<p>27</p>  <p>Roof connecting bar - 2pcs</p>
<p>28</p>  <p>Roof connecting bar - 2pcs</p>	<p>29</p>  <p>Roof connecting bar - 2pcs</p>
<p>30</p>  <p>Roof connecting bar - 12pcs</p>	<p>31</p>  <p>Roof connecting bar - 2pcs</p>
<p>32</p>  <p>Right Roof panel - 4pcs</p>	<p>33</p>  <p>Left Roof panel - 4pcs</p>
<p>34</p>  <p>Rear center column - 1pc</p>	

<p>1</p>  <p>Horizontal board - 2pcs</p>	<p>2</p>  <p>Left front bed column - 1pc</p>
<p>3</p>  <p>Left rear bed column - 1pc</p>	<p>4</p>  <p>Right rear bed column - 1pc</p>
<p>5</p>  <p>Right front bed column - 1pc</p>	<p>7</p>  <p>Rear guard rail - 2pcs</p>
<p>8</p>  <p>Bed side plate - 2pcs</p>	<p>9</p>  <p>Bed side plate - 2pcs</p>
<p>12</p>  <p>Horizontal board - 2pcs</p>	<p>13</p>  <p>Bed board - 21pcs</p>
<p>14</p>  <p>Horizontal board - 2pcs</p>	<p>15</p>  <p>Bed ladder column - 1pc</p>
<p>16</p>  <p>Bed ladder column - 1pc</p>	<p>17</p>  <p>Ladder step - 3pcs</p>

18



Slide column - 1pc

19



Slide column - 1pc

20

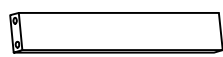

Slide support wood - 6pcs

21

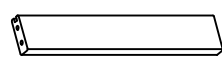

Slide baffle - 1pc

22

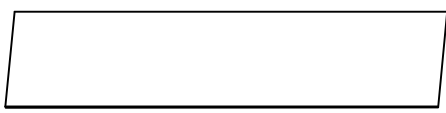

Skate - 1pc

23

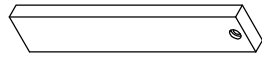





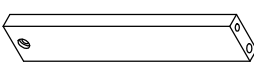





Right guard rail - 2pcs

24

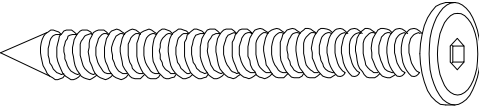
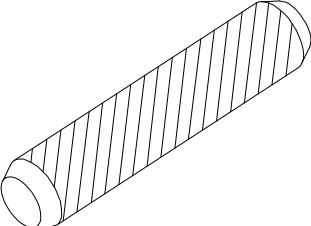
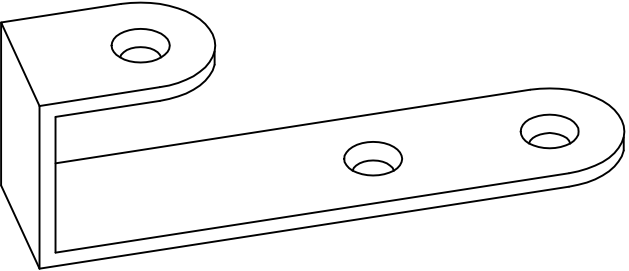

Right guard rail - 2pcs

A  $\varnothing 13 \times 1/4" \times 70 \text{mm}$ Hex-Head bolts(16pcs)	B  $\varnothing 13 \times 1/4" \times 40 \text{mm}$ Hex-Head bolts(8pcs)	C  $\varnothing 13 \times \varnothing 1/4 \times 90 \text{mm}$ Hex-Head screw(16pcs)
D  $\varnothing 13 \times \varnothing 1/4 \times 60 \text{mm}$ Hex-Head screw(14pcs)	F  $\varnothing 13 \times \varnothing 1/4 \times 40 \text{mm}$ Hex-Head screw(4pcs)	G  $\varnothing 10 \times 13 \text{mm}$ Horizontal-Hole bolts(16pcs)
H  $\varnothing 8 \times \varnothing 4 \times 30 \text{mm}$ Round head screw(42pcs)	J  $\varnothing 7 \times \varnothing 3.5 \times 18 \text{mm}$ Flat head screw(6pcs)	K  4mm Allen key(1pc)
M  $\varnothing 8 \times \varnothing 4 \times 15 \text{mm}$ Round head screw(72pcs)	E  $\varnothing 13 \times \varnothing 6.2 \times 50 \text{mm}$ Hex-Head screw(72pcs)	
L  $\varnothing 10 \times 40 \text{mm}$ Wood dowel(74pcs)	I  $\varnothing 75 \times 18 \times 24 \text{mm}$ Stair hook(2pcs)	

ASSEMBLY TOOLS REQUIRED (NOT INCLUDED)

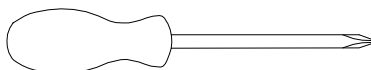



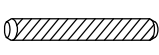

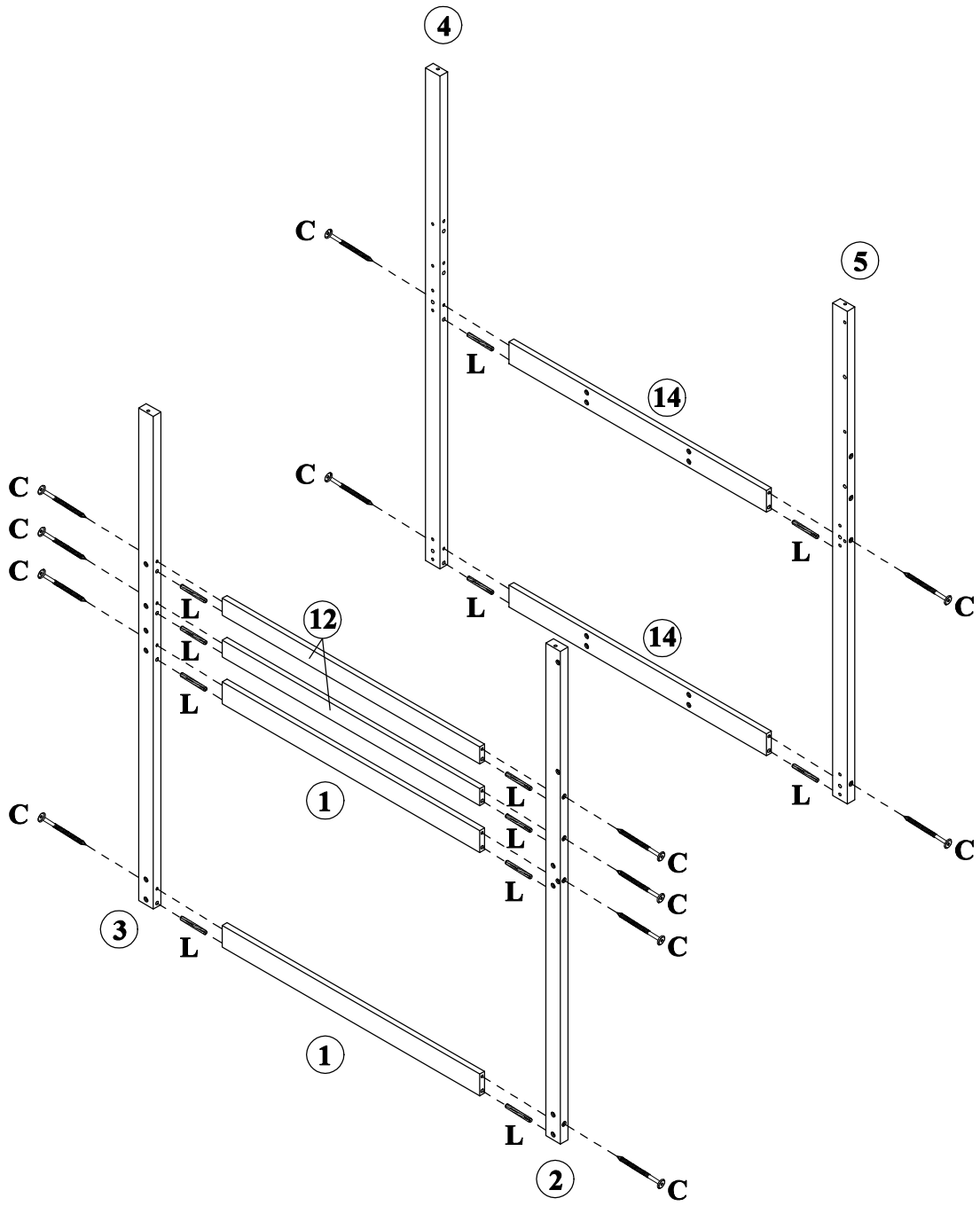
STEP: 1

C	L
	
12PCS	12PCS



STEP: 2

A	B	D	F	G
				
16PCS	4PCS	4PCS	4PCS	16PCS

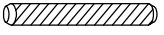
L

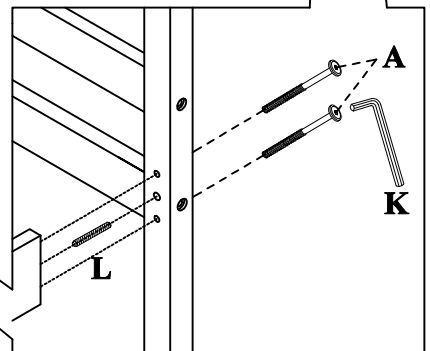
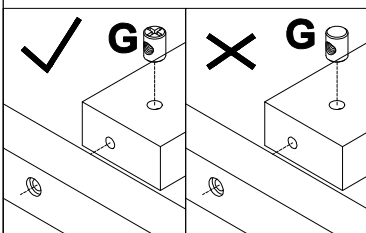
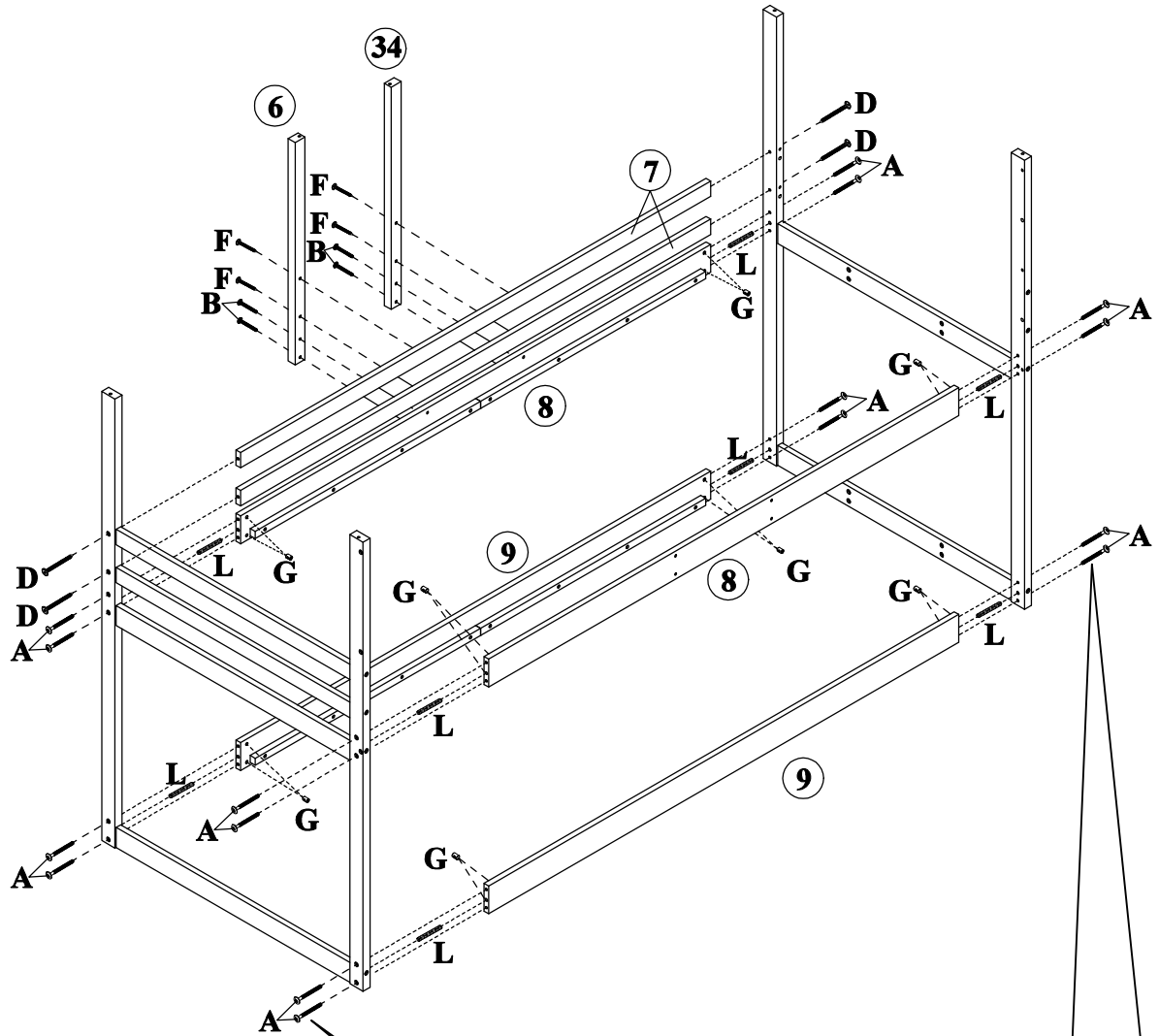
8PCS

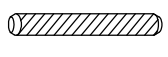

STEP: 3

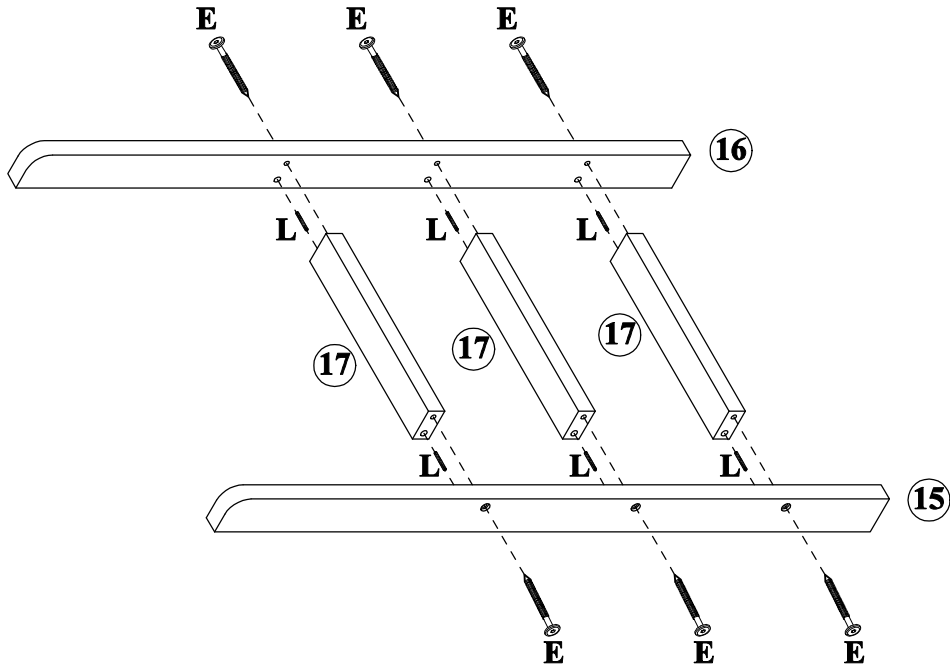
E	L
	
6PCS	6PCS



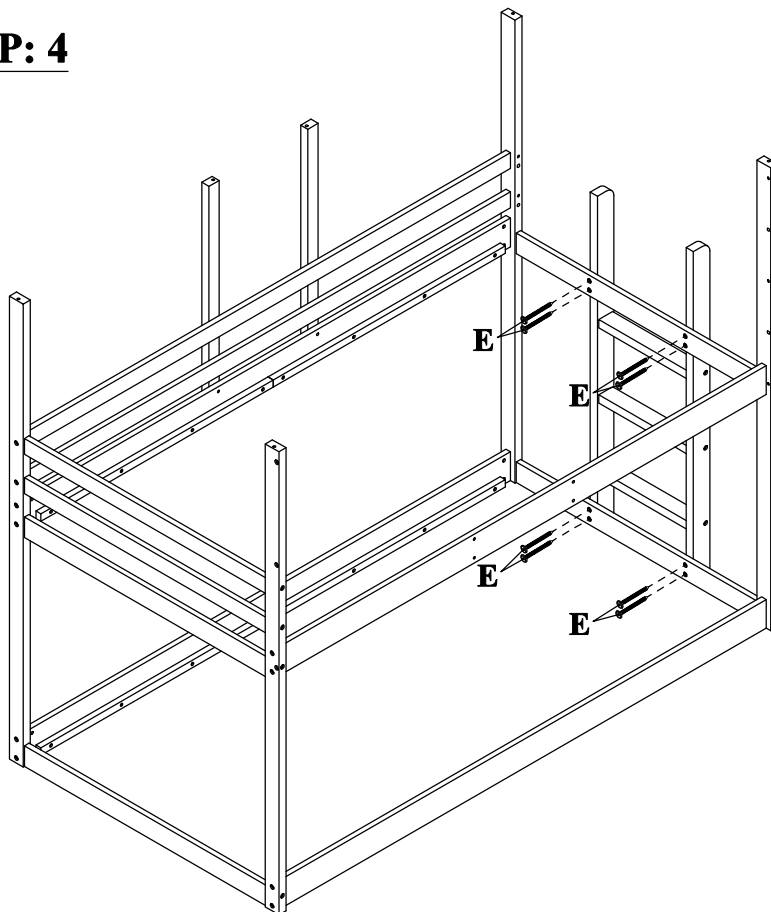

STEP: 4

E

8PCS

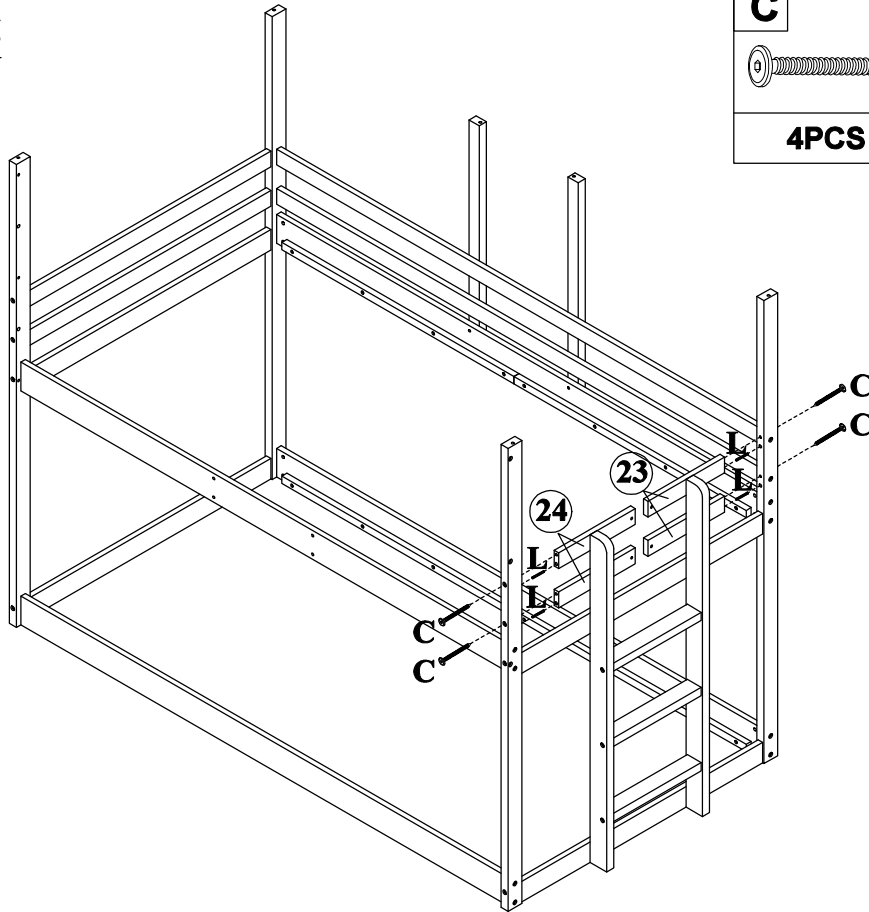

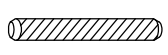

STEP: 5



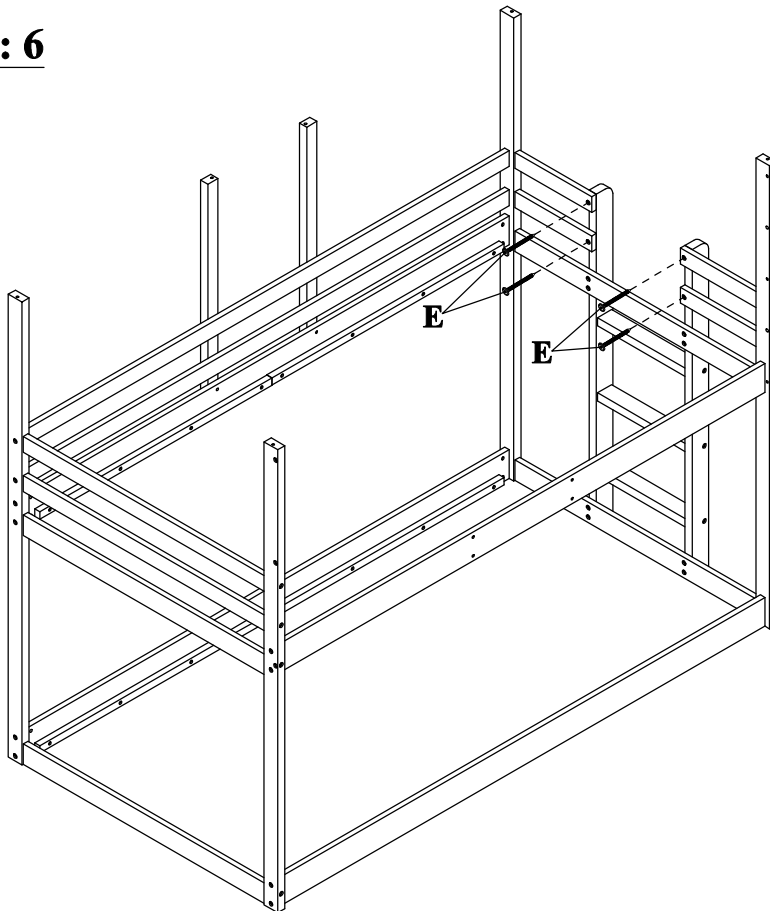

C	L
	
4PCS	4PCS

STEP: 6





E

4PCS

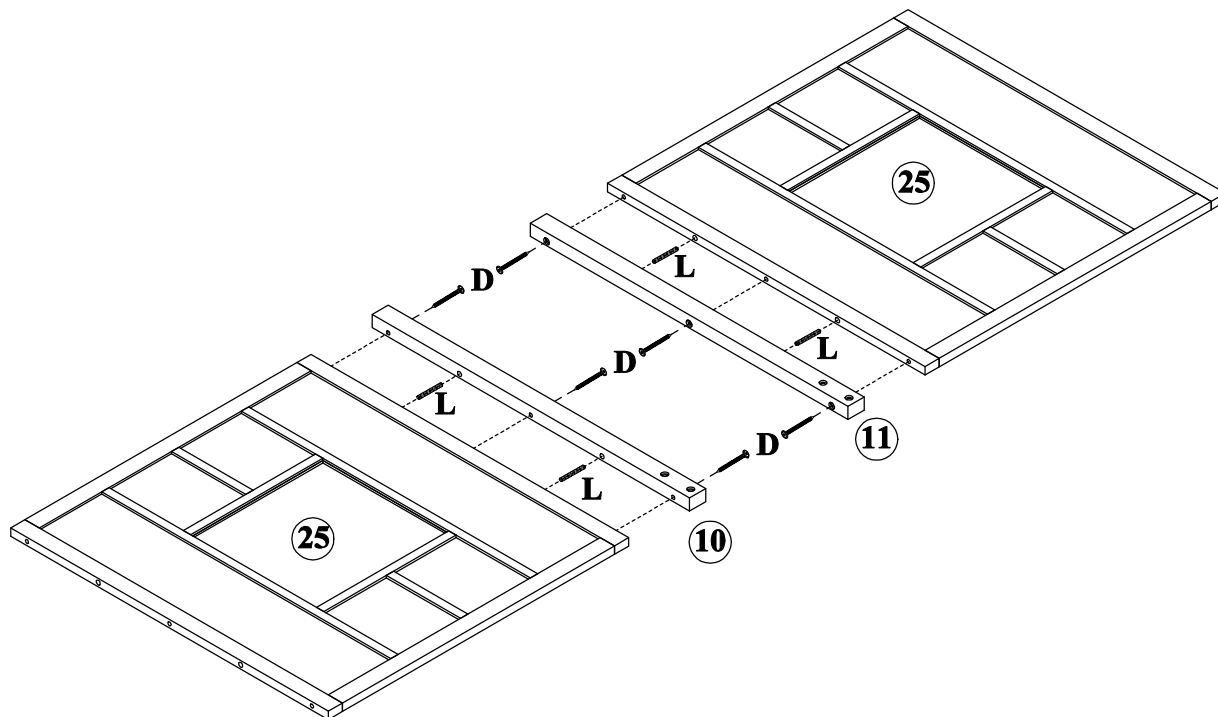
STEP: 7

D	L
	
6PCS	4PCS



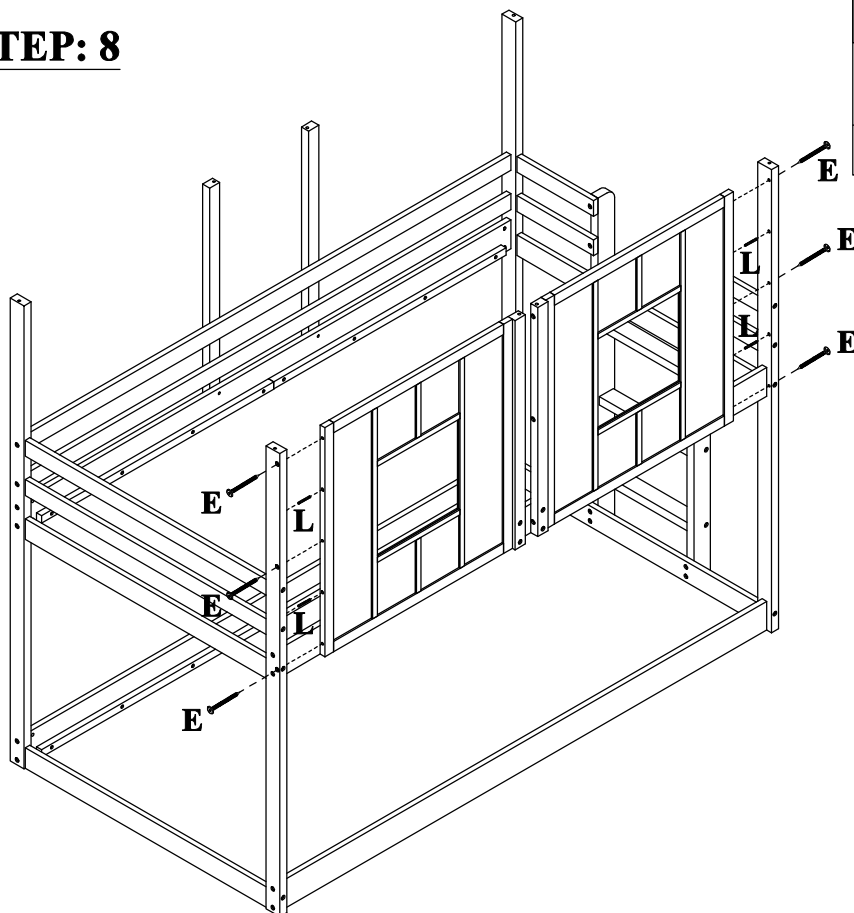

STEP: 8

E	L
	
6PCS	4PCS

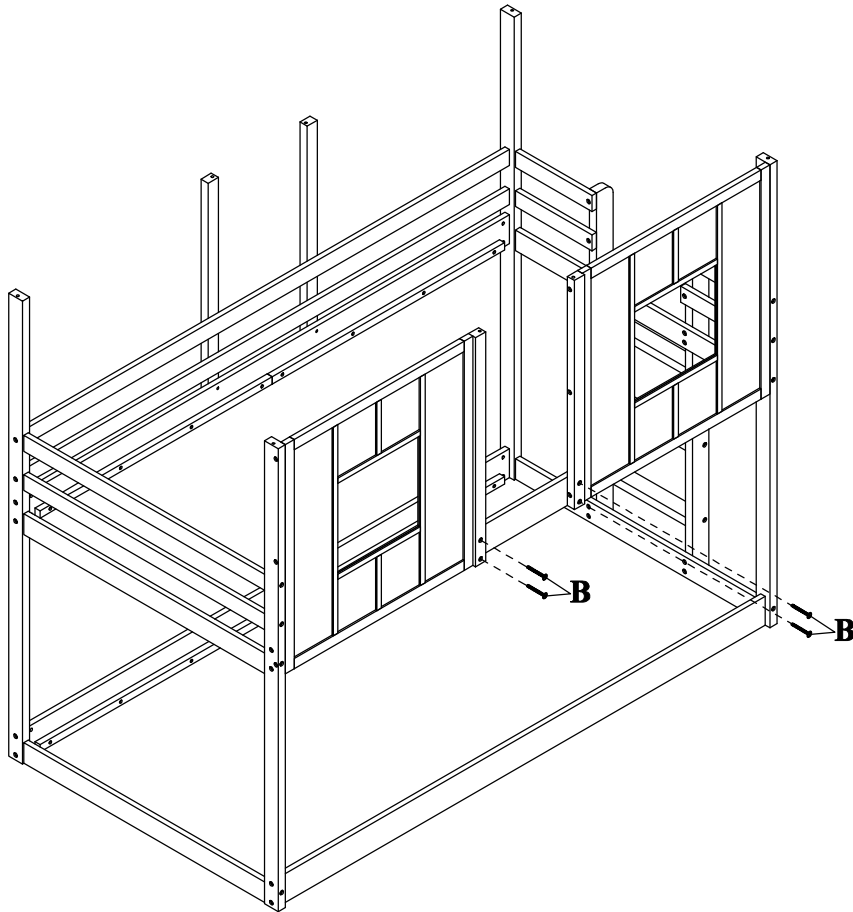

STEP: 9



B

4PCS

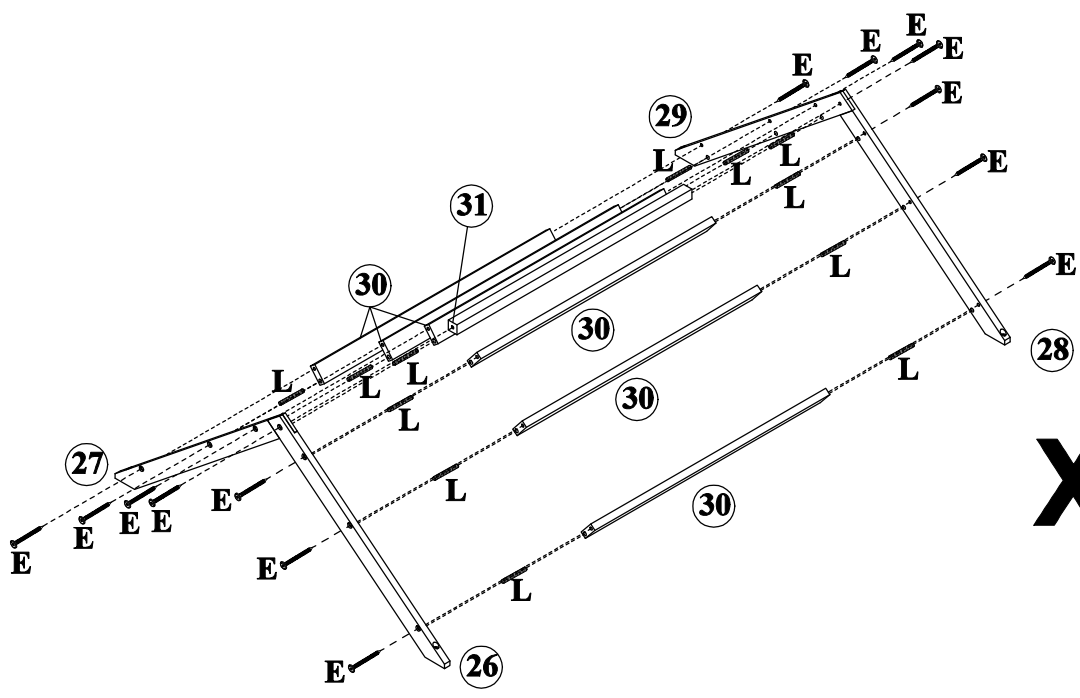

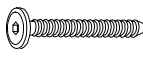
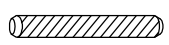
STEP: 10



E	L
	
28PCS	24PCS

X 2

STEP: 11

D	E
	
4PCS	4PCS

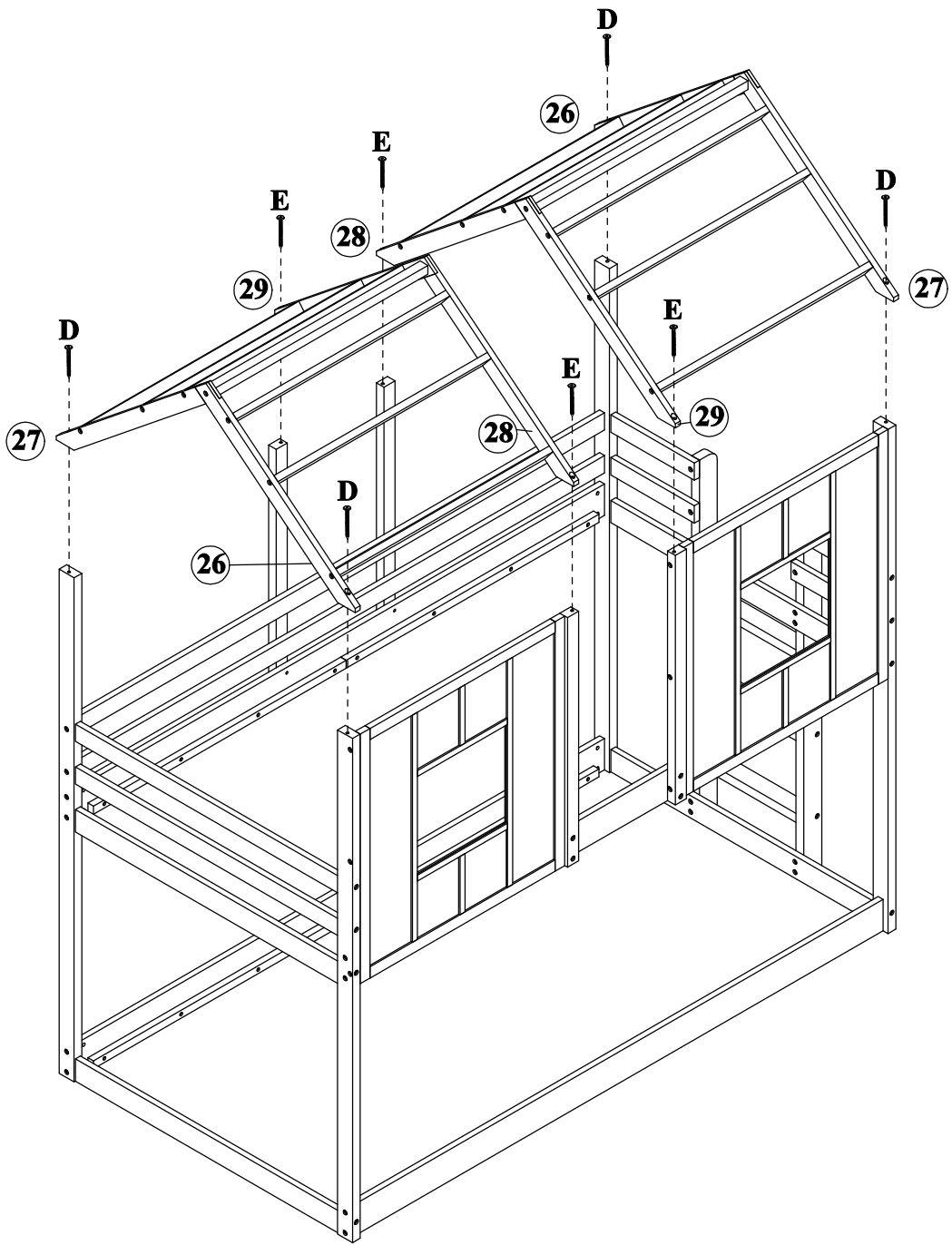

STEP: 12



M

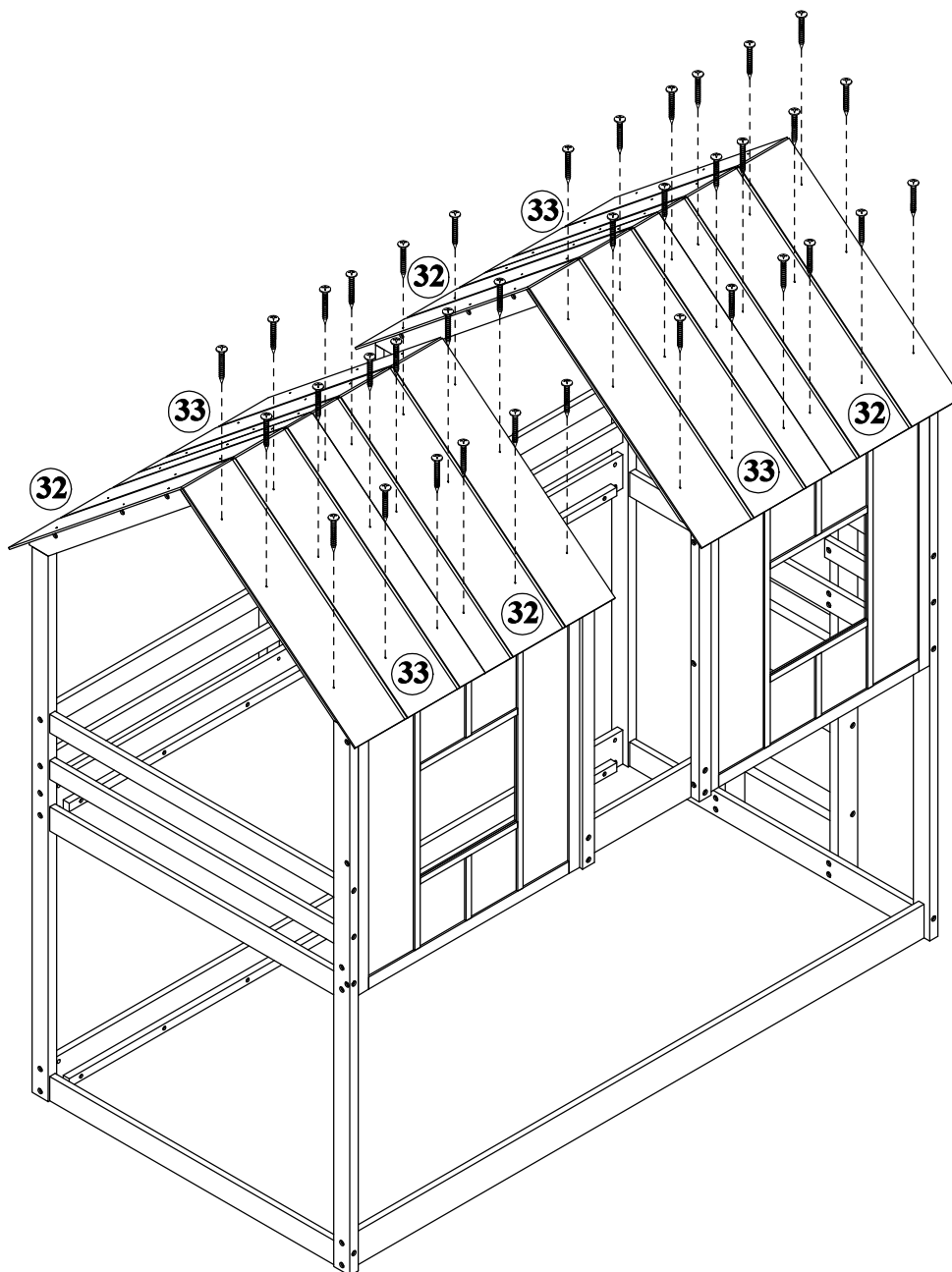

72PCS

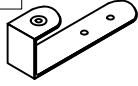
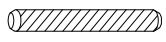

STEP: 13

E 	J 	I 	L 
16PCS	4PCS	2PCS	12PCS

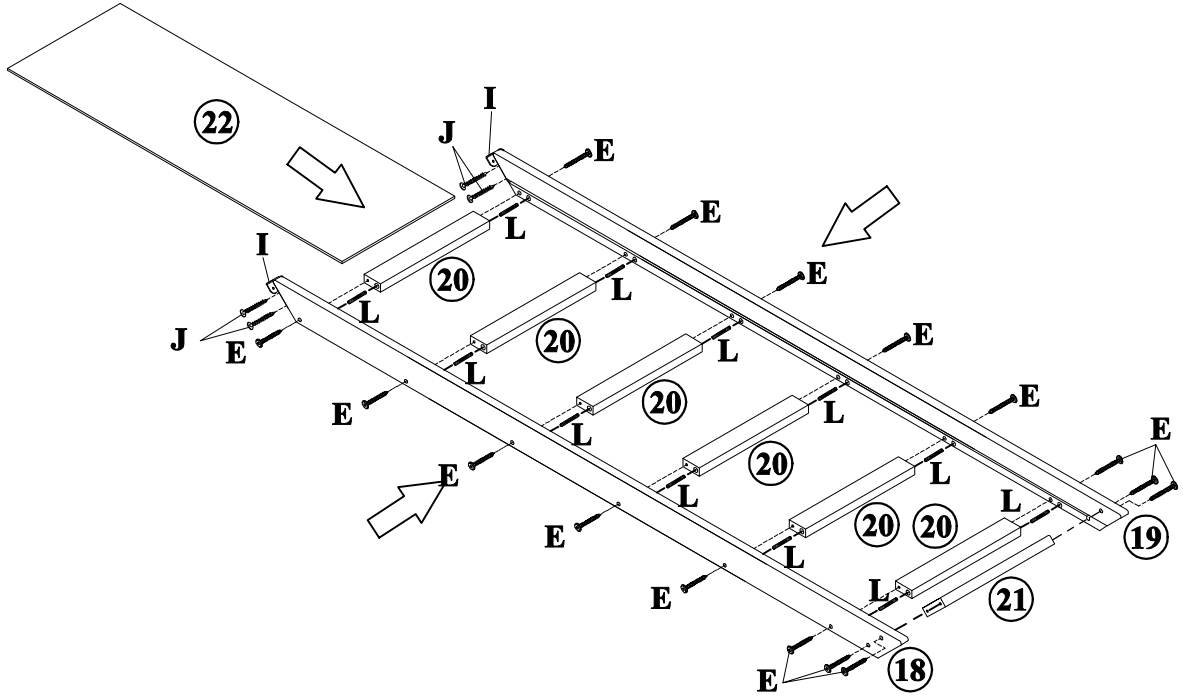

STEP: 14

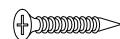
H 	J 
42PCS	2PCS

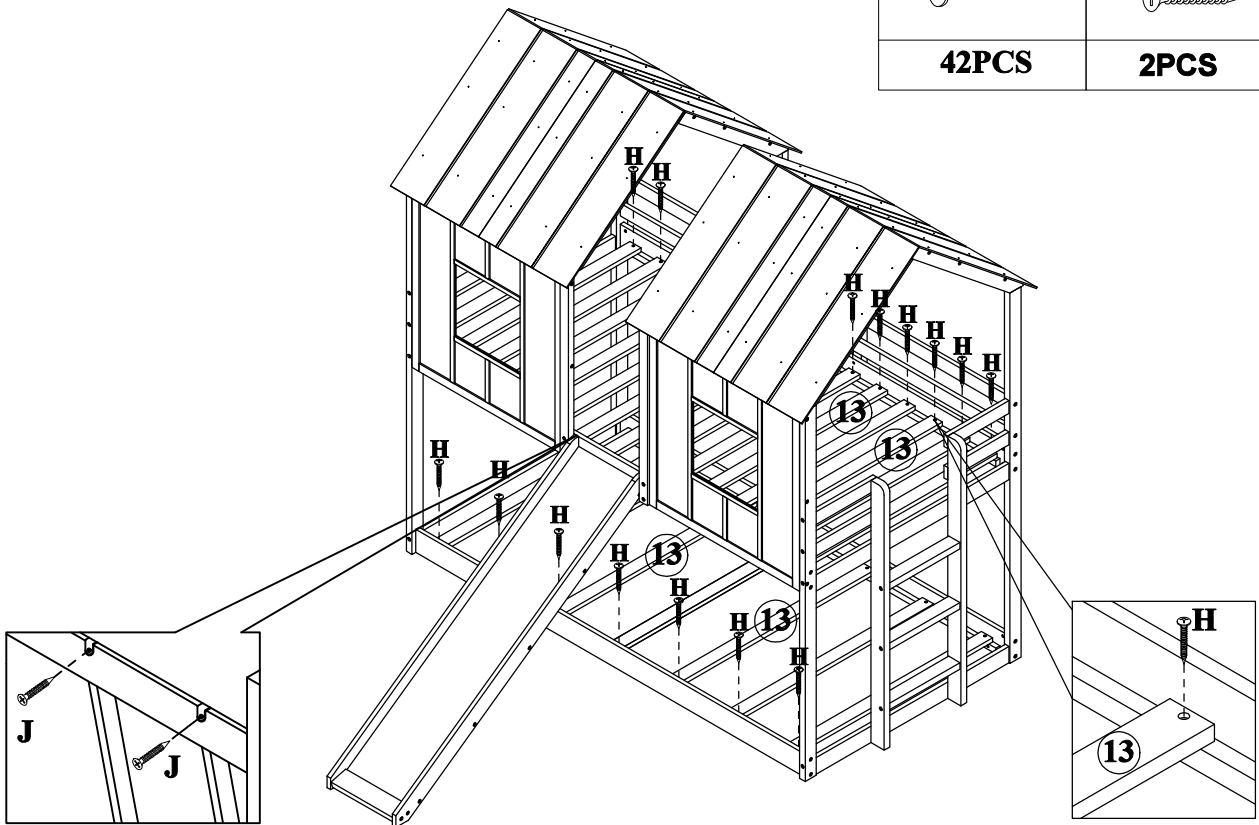

STEP: 15

