











Assemble instruction

NO	Picture	Name	Qty
A		Table Top	1
B		Table Leg (left)	2
C		Table Leg (right)	2
D		Support Frame	4
E		M10 Nut	4
F		Spring Washer	4
G		Washer	4
H		Adjusting the footrest (left)	2
I		Adjusting the footrest (right)	2
J		Nut Wrench	1

STEP 1

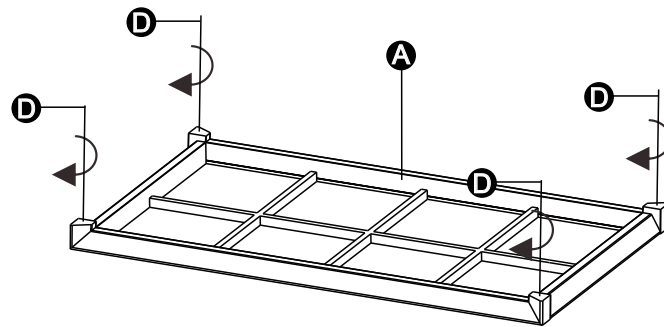

STEP 2

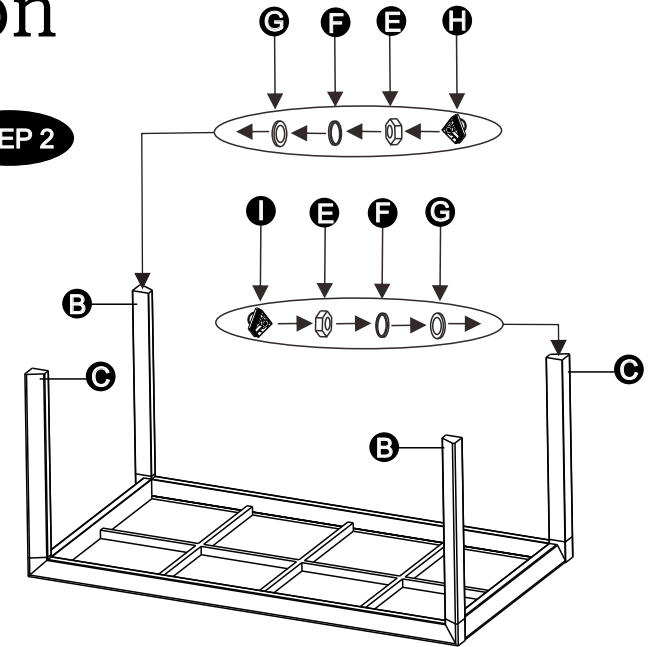

STEP 3



Let op: Bij het monteren van het meubel eerst alle schroeven half indraaien.
Pas als alle schroeven op de plek zitten alles vast draaien.

Note: When assembling the furniture, first screw all screws halfway.
When all the screws are in place, tighten everything.

Achtung! Um die Montage des Möbelstückes zu vereinfachen,
erst alle Schrauben handfest andrehen und am Ende erst alle Schrauben
fest anziehen.

Attention: Avec votre meuble, tous les visser par rapidement monter.
Ci tout sur son place, vous pouvez les monter.