

ASSEMBLY INSTRUCTION

Friendly Reminder:

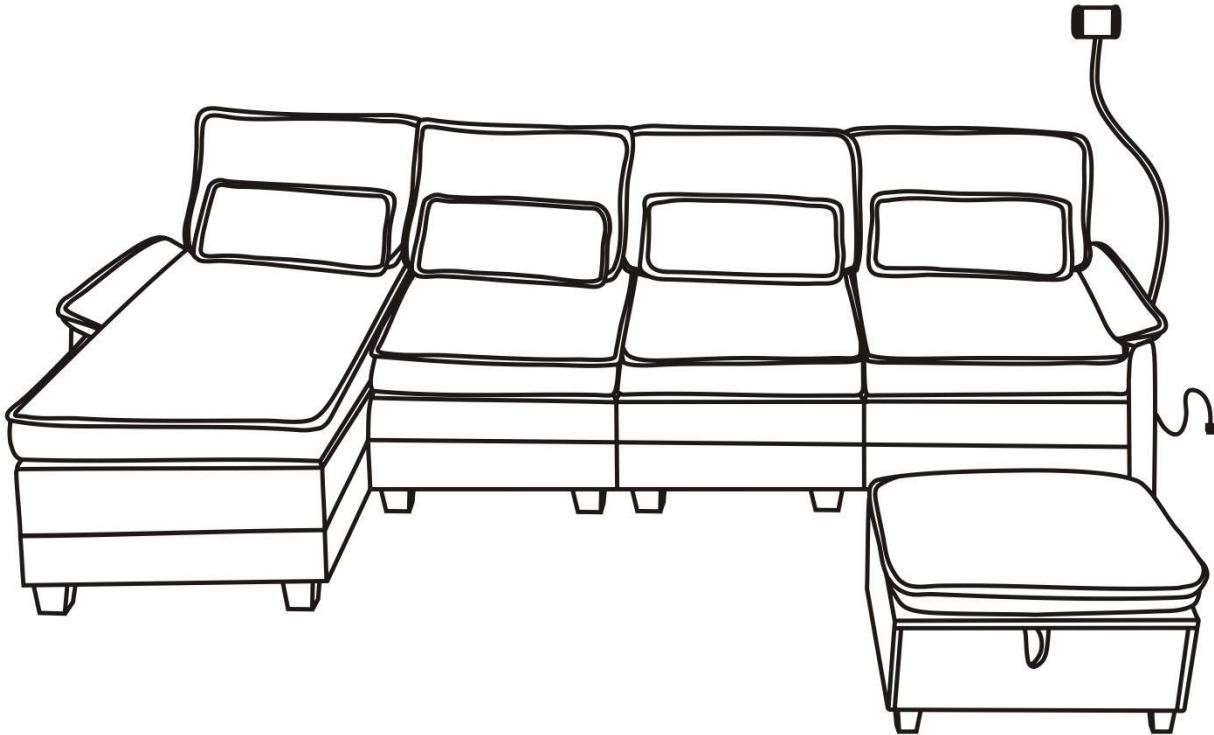











- 1.This sofa is packed in 3 boxes. Please assemble it after all boxes are received.
- 2.As the cushions are all vacuum compressed,there will be some wrinkles.Please give your cushions up to 72 hours to reach its original size and the wrinkles will basically disappear.
- 3.Please do not open the compressed packages until your sofa frame is completely assembled.











Return & Warranty policy:



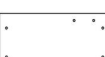





- We strive to offer the highest quality products,and we also try our best to satisfy each and every customer that orders from us with replacement parts or service as needed.
- If the item is damaged or defective, please take photos as evidence for replacements and refunds.
- Please do not return to store,contact the seller if you have any troubles with this product.









ASSEMBLY INSTRUCTION

HARDWARE			
NO	DESCRIPTION	SKETCH	QTY
1	Washer		48
2	Gasket		20
3	Screws 8X60		24
4	Screws 8X80		12
5	Screws 6X16		24
6	Butterfly nut		8
7	Wrench		12
8	Spring hinge		2
9	Steel angle bracket		4
10	Hexagon wrench		1
11	Plastic nut(black)		1
12	Hardware nut		1

PARTS LIST BOX 1			
NO	DESCRIPTION	SKETCH	QTY
A2	Seat frame		1
B2	Seat cushion		1
E	Back frame		1
F	Back cushion		1
H3	Ottoman frame (right part)		1
H4	Ottoman frame (left part)		1
I	Ottoman cushion		1
J	Pillow		1
K	Phone holder		1

ASSEMBLY INSTRUCTION

PARTS LIST BOX 2			
NO	DESCRIPTION	SKETCH	QTY
A1	Seat frame		2
B1	Seat cushion		2
C1	Left armrest		1
D	Armrest bag		2
E	Back frame		2
F	Back cushion		2
H1	Ottoman frame (bottom part)		1
H2	Ottoman frame (front and back part)		2
J	Pillow		2

PARTS LIST BOX 3			
NO	DESCRIPTION	SKETCH	QTY
A1	Seat frame		1
B1	Seat cushion		1
C2	Right armrest		1
E	Back frame		2
F	Back cushion		2
G	Legs		20
J	Pillow		1
L	Phone clamp		1
M	Hardware		1

ASSEMBLY INSTRUCTION

All parts and hardware.

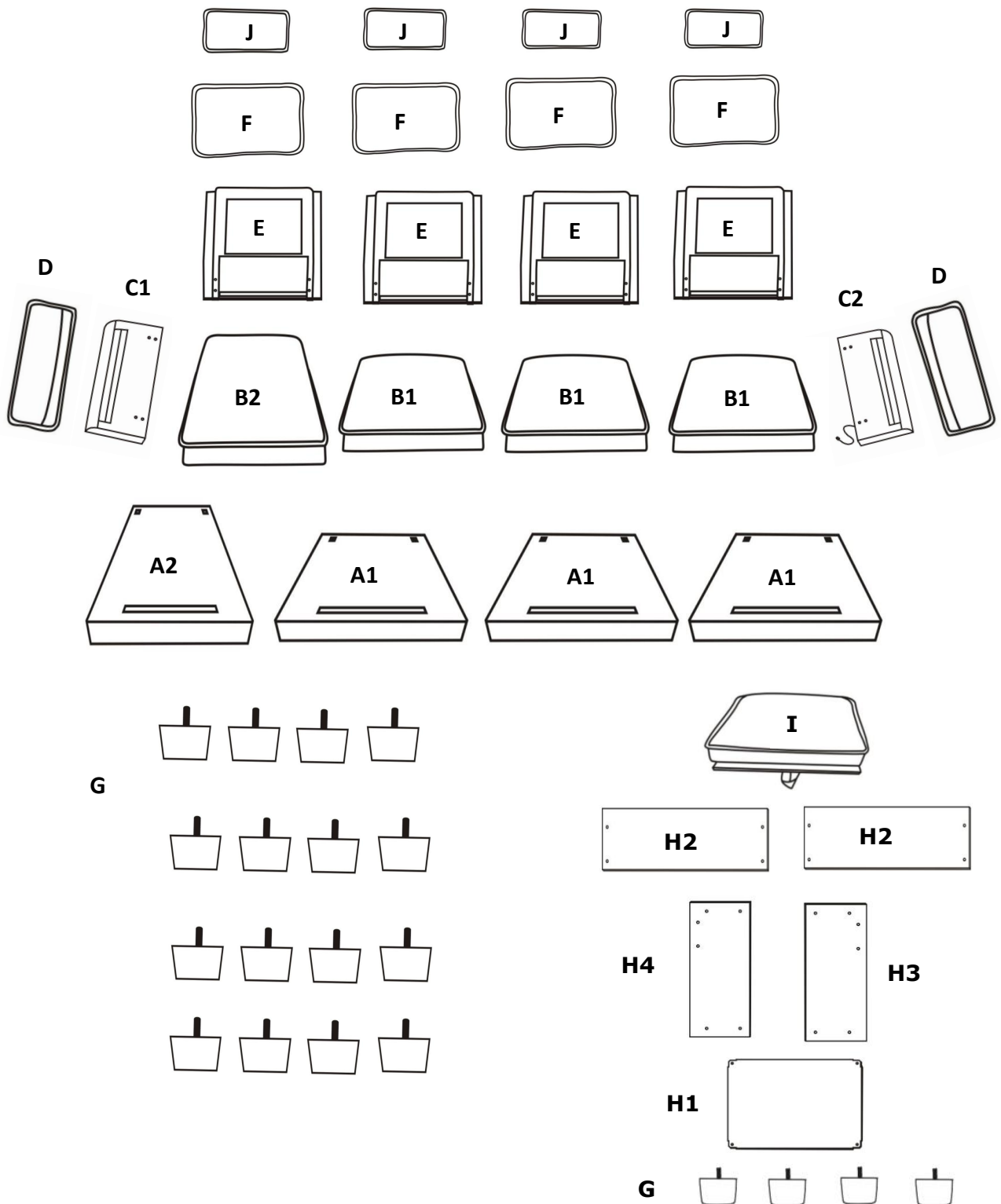



DIAGRAM 1 (Assemble the Armrest)

Assemble the Left and Right Armrests(Part C1 and Part C2) to the Seat Frame(Part A1 and Part A2) with Washers(Hardware 1) and Screws(Hardware 3).

1		8PCS
3	 M8X60	8PCS

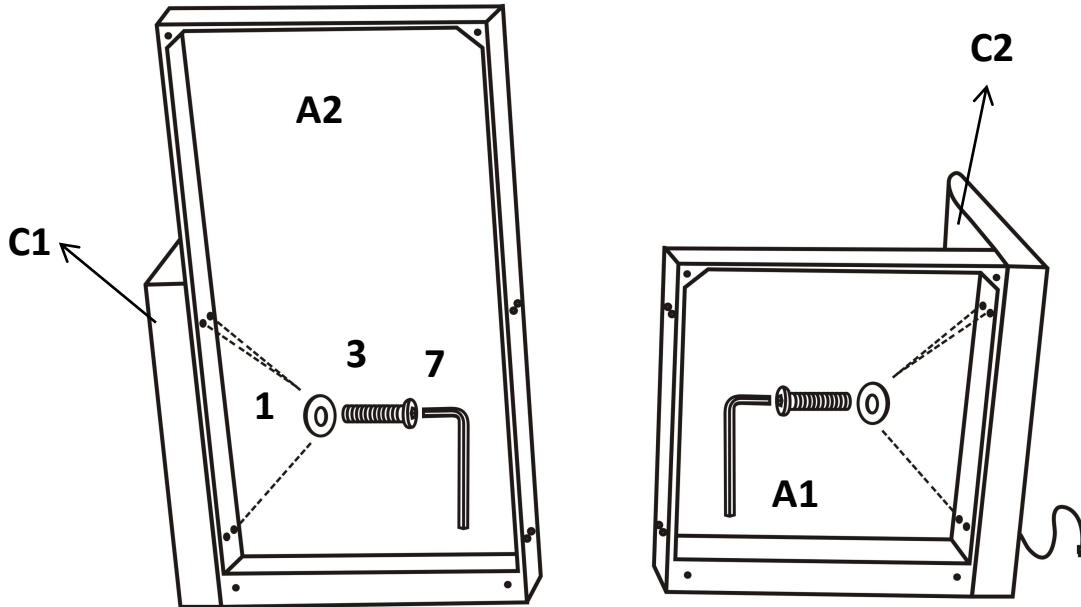

DIAGRAM 2 (Assemble the Seat frame)

Assemble Seat Frame(Part A1) and Seat Frame(Part A2) with Butterfly Nuts(Hardware 6) ,Washers(Hardware 1) and Screws(Hardware 4).

1		24PCS
4	 M8X80	12PCS
6		12PCS

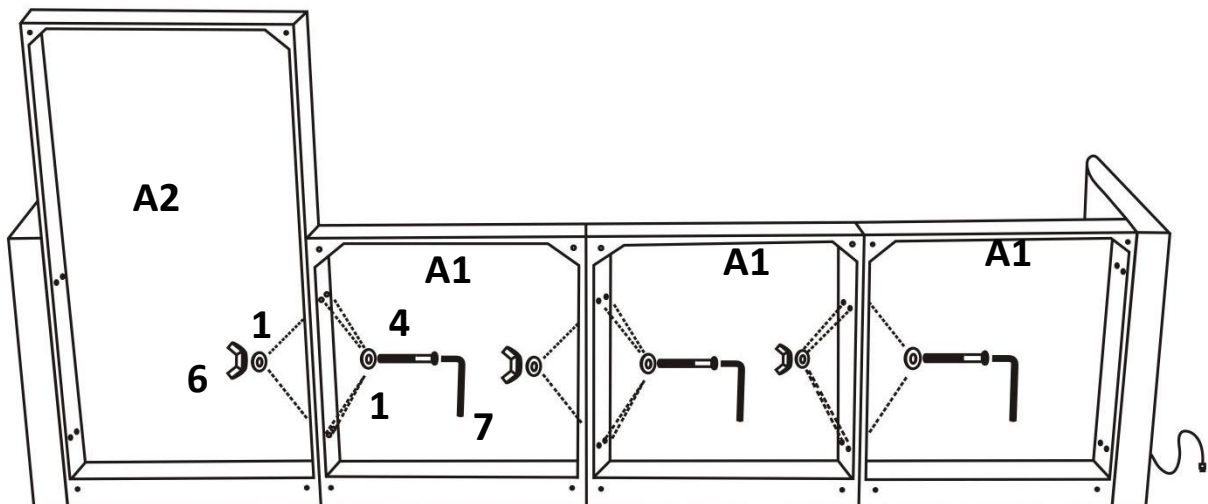

DIAGRAM 3 (Assemble the Legs)

Assemble the Legs(Part G) on the sofa with Gaskets(Hardware 2).

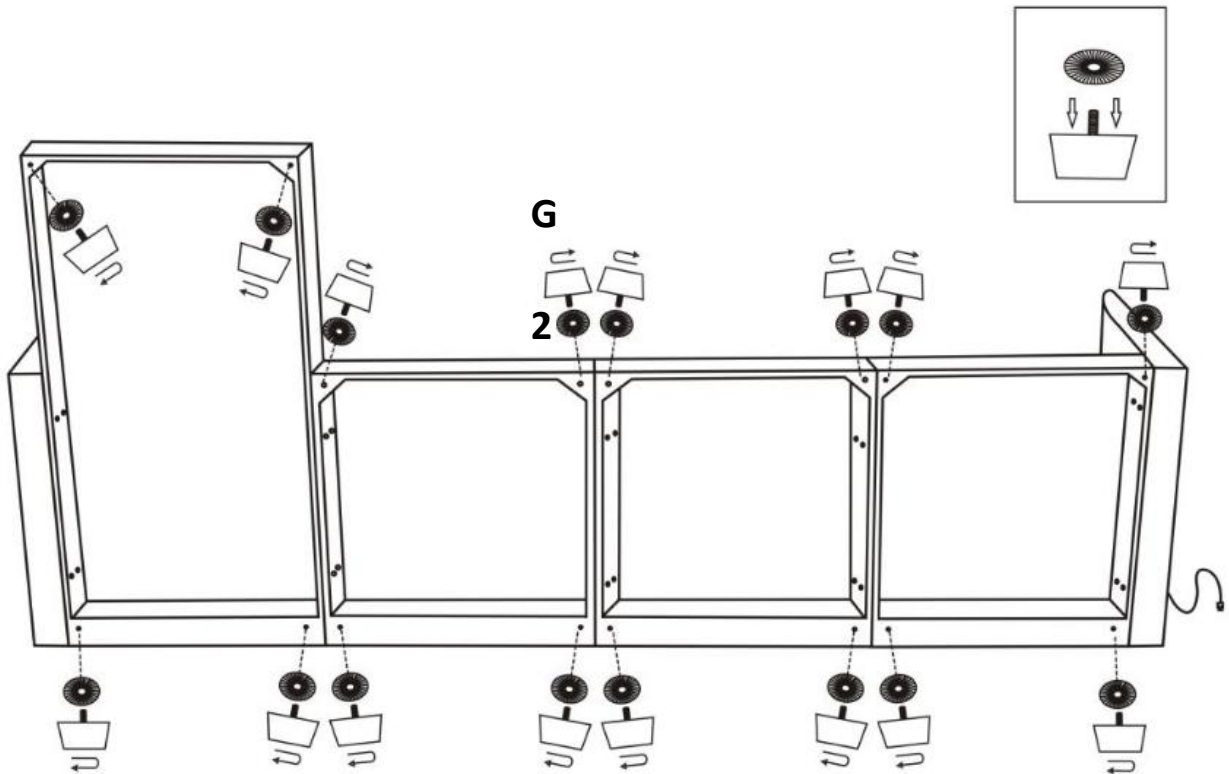



DIAGRAM 4 (Assemble the Back frame)

1		16PCS
3	 M8X60	16PCS

Insert the Backrest(Part E) into the designated holes,using Washers(Hardware 1) and Screws(Hardware 3) to 70% tightness,and then tighten the all on Screws the seat.

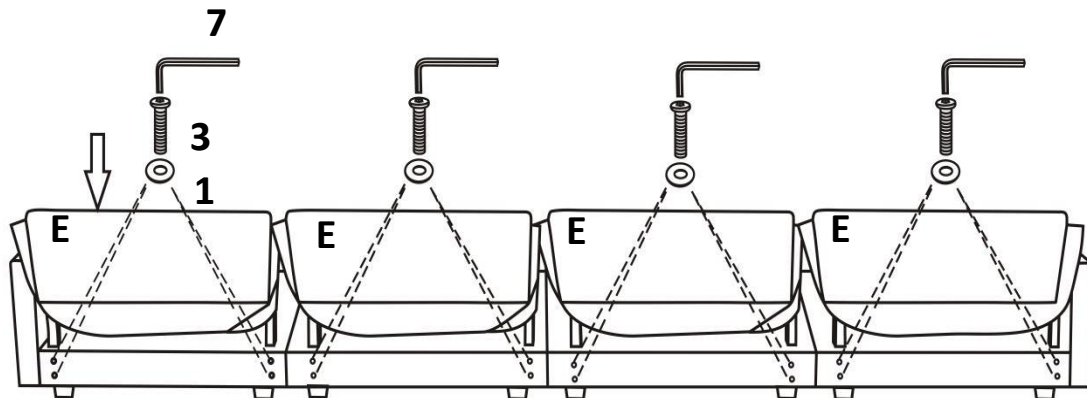
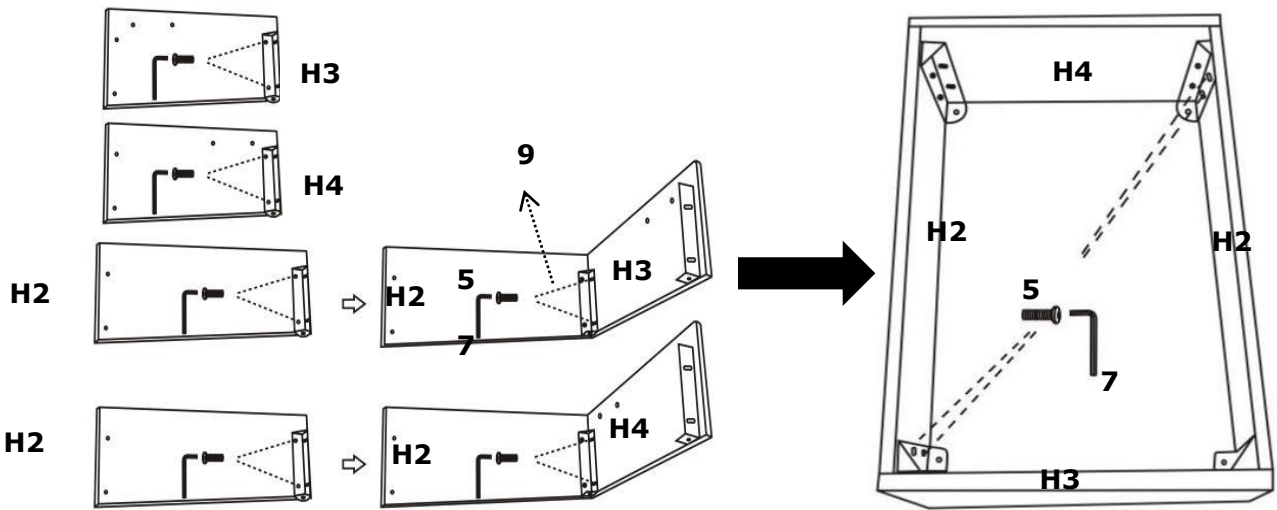
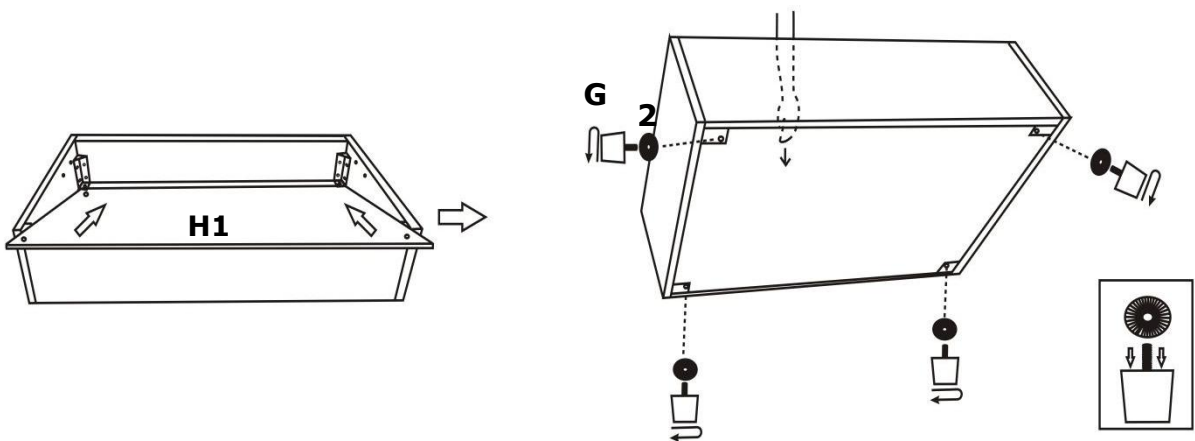

DIAGRAM 5 (Install the footrest)

- ❖ 1. Assemble the Ottoman frame, using Steel angle bracket(Hardware 9) and Screws(Hardware 5) .



- ❖ 2. Put the bottom part of Ottoman frame (H1) into the assembled frame, and then assemble the Legs(Part G) on the ottoman frame with Gaskets(Hardware 2).



- ❖ 3. Assemble the Ottoman cushion(I), using the Spring hinge(Hardware 8) and Screws (Hardware 5).

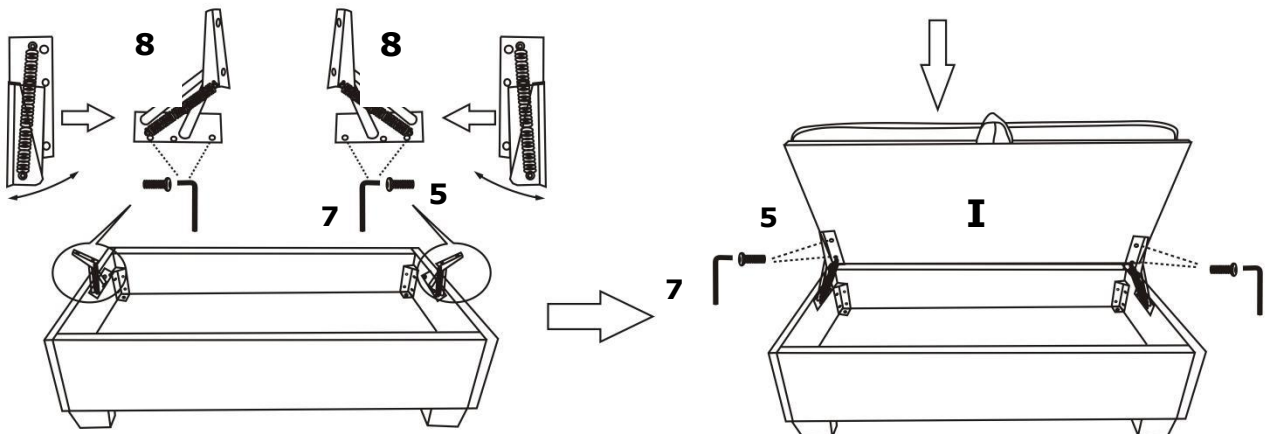

DIAGRAM 6 (Open the compressed packages)

The cushions is packaged by vacuum compression. After cutting the package, it rebounds quickly within 4 hours. If the fabric has wrinkles, it will basically disappear after standing for 72 hours.

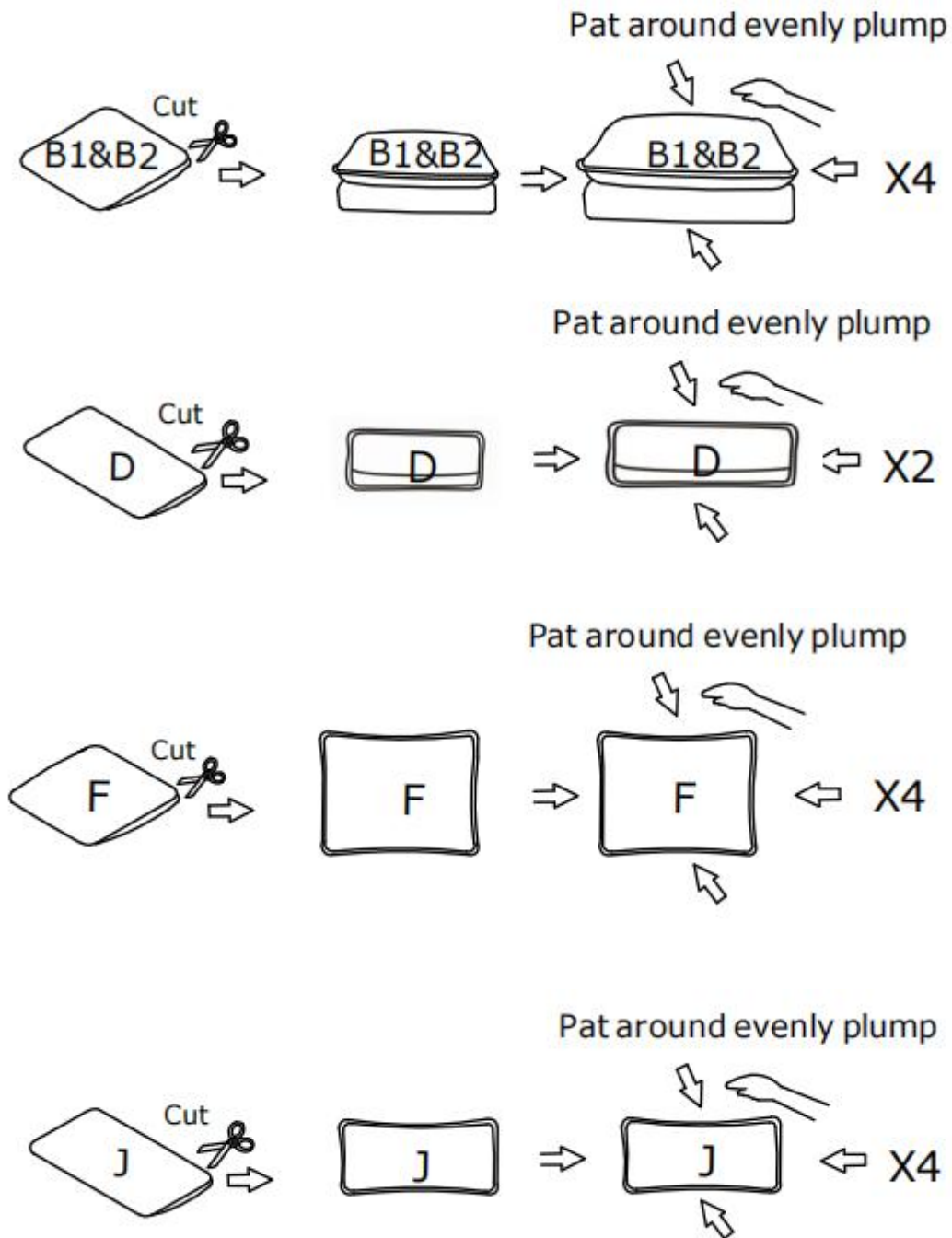

DIAGRAM 7 (Assemble the Armrest bags)

As shown in the figure, assemble the Armrest bags(Part D) to the Left Armrest (Part C1) and the Right Armrest(Part C2).

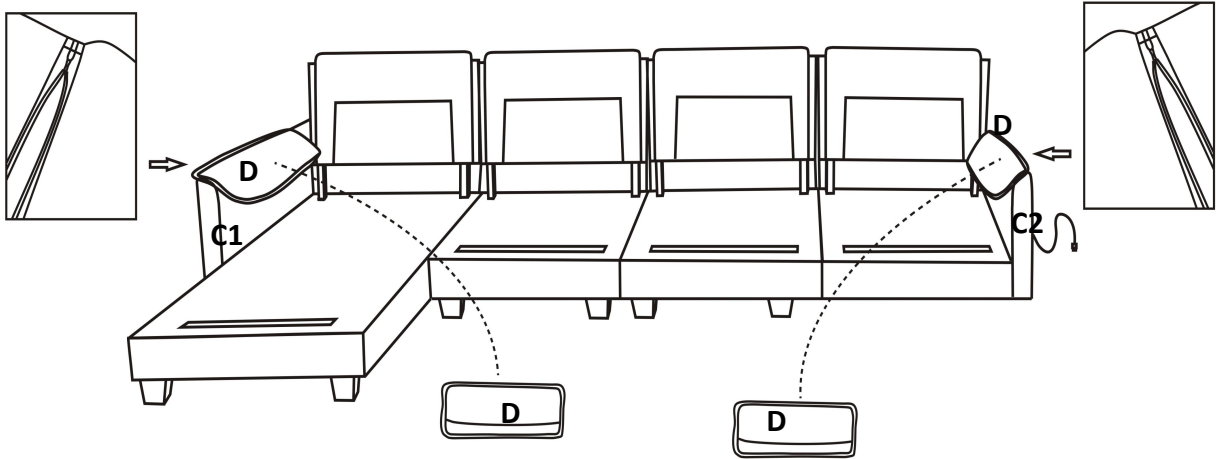

DIAGRAM 8 (Assemble the Cushions)

Placing the Seat cushions(Part B1 and part B2),Back Cushions(Part F),and pillows(Part J) on the sofa in that order.

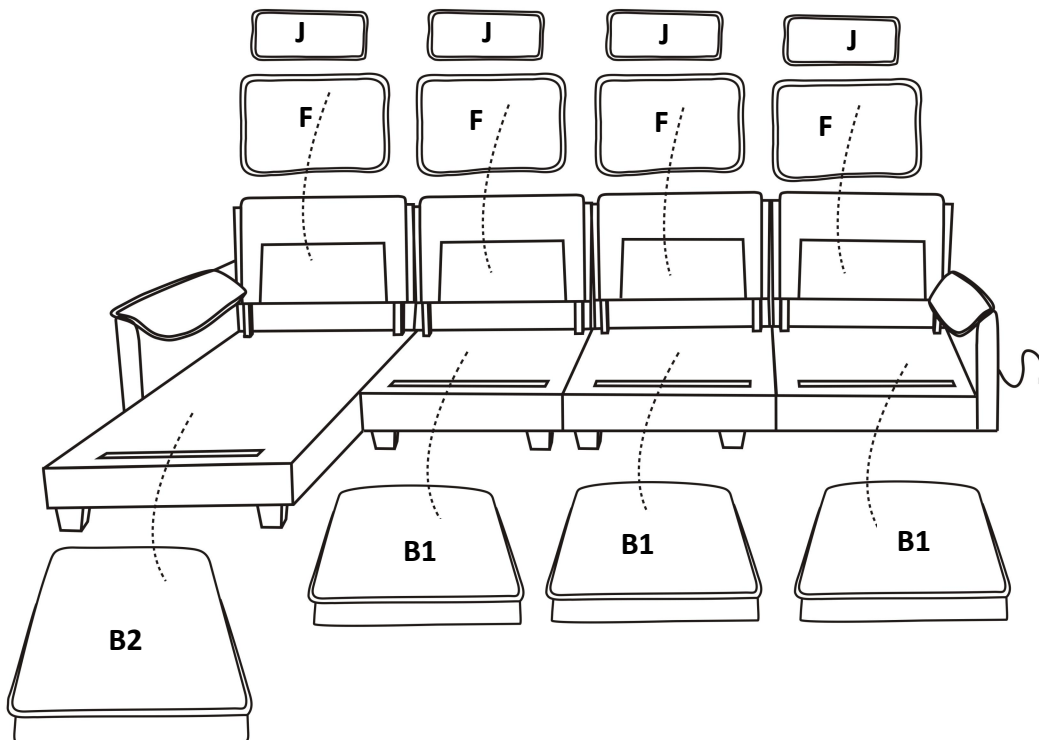
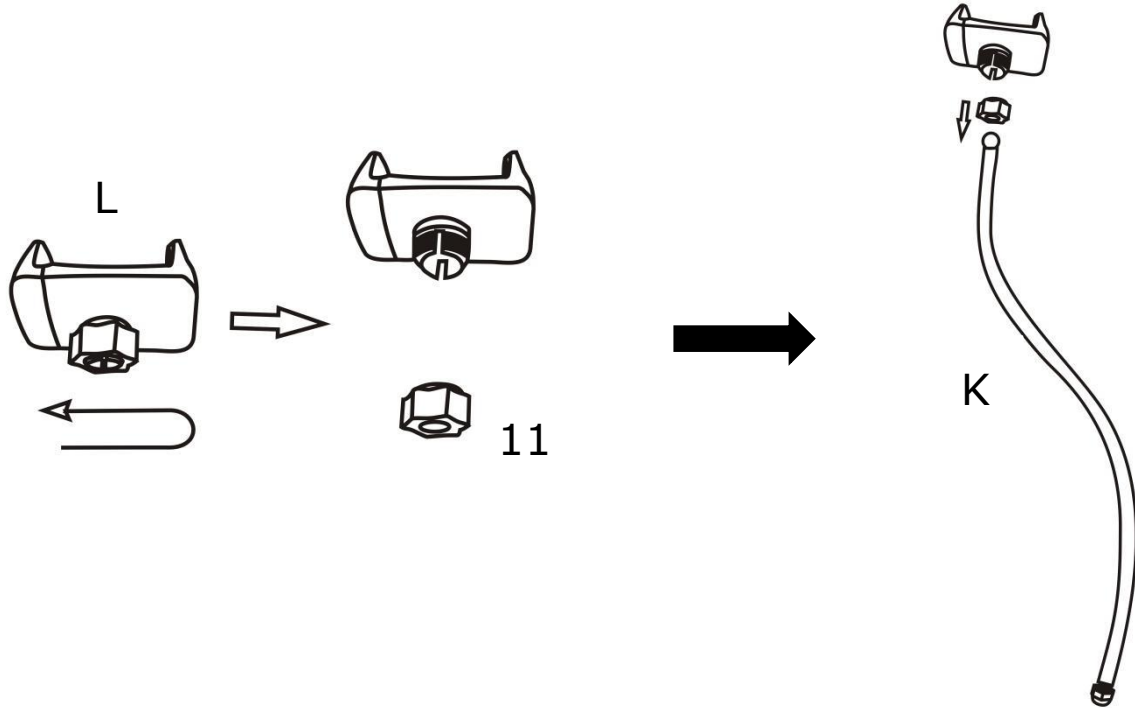
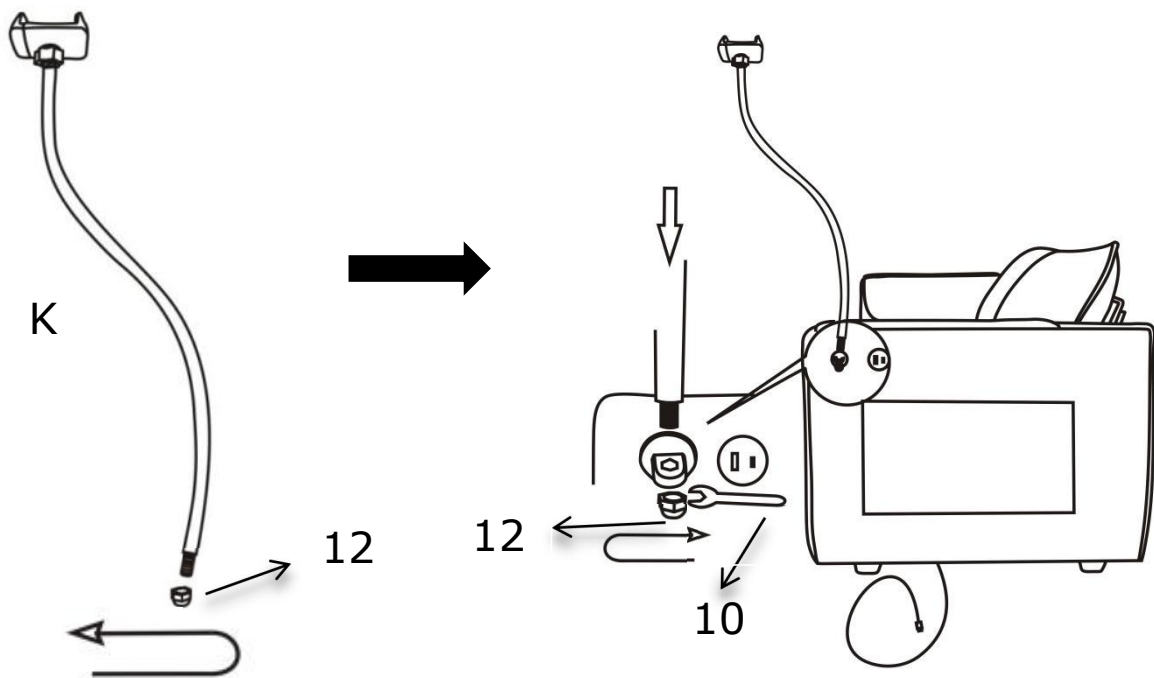

DIAGRAM 9 (Assemble the Phone holder)

First, unscrew the Black plastic nut(Hardware 11) from the Phone clamp (Part L), put it on the upper end of the Phone holder(Part K) , and then connect it to the phone clamp(Part L) and tighten it.



Then, unscrew the Hardware nut(Hardware 12) at the bottom of the Phone holder (Part K) and use Hexagon wrench(Hardware 10) to fix the holder to the sofa.



TIPS:

1. Please do not open the compress packaging until your sofa frame is completely assembled.
2. Compress back cushions and pillows need to be fully fulfilled within 72 hours for your perfect use.
3. Please keep children away from plastic bags or any small pieces of stuff.

