

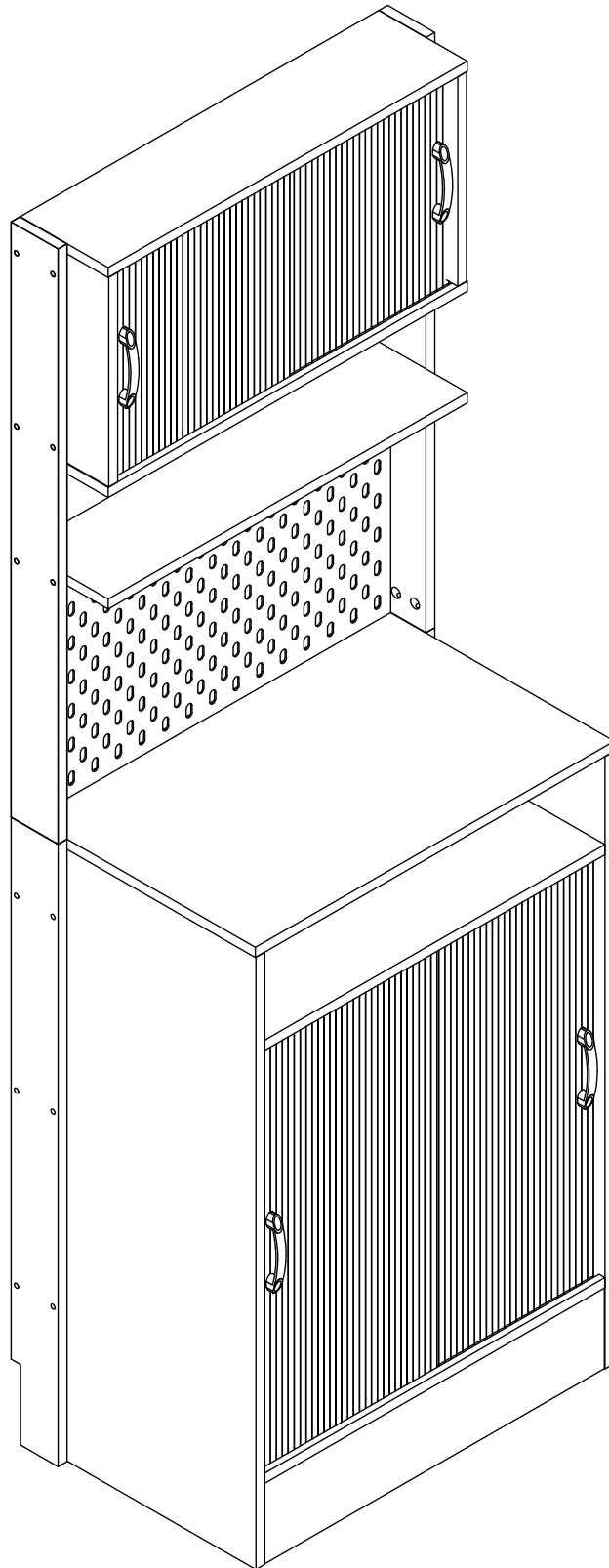

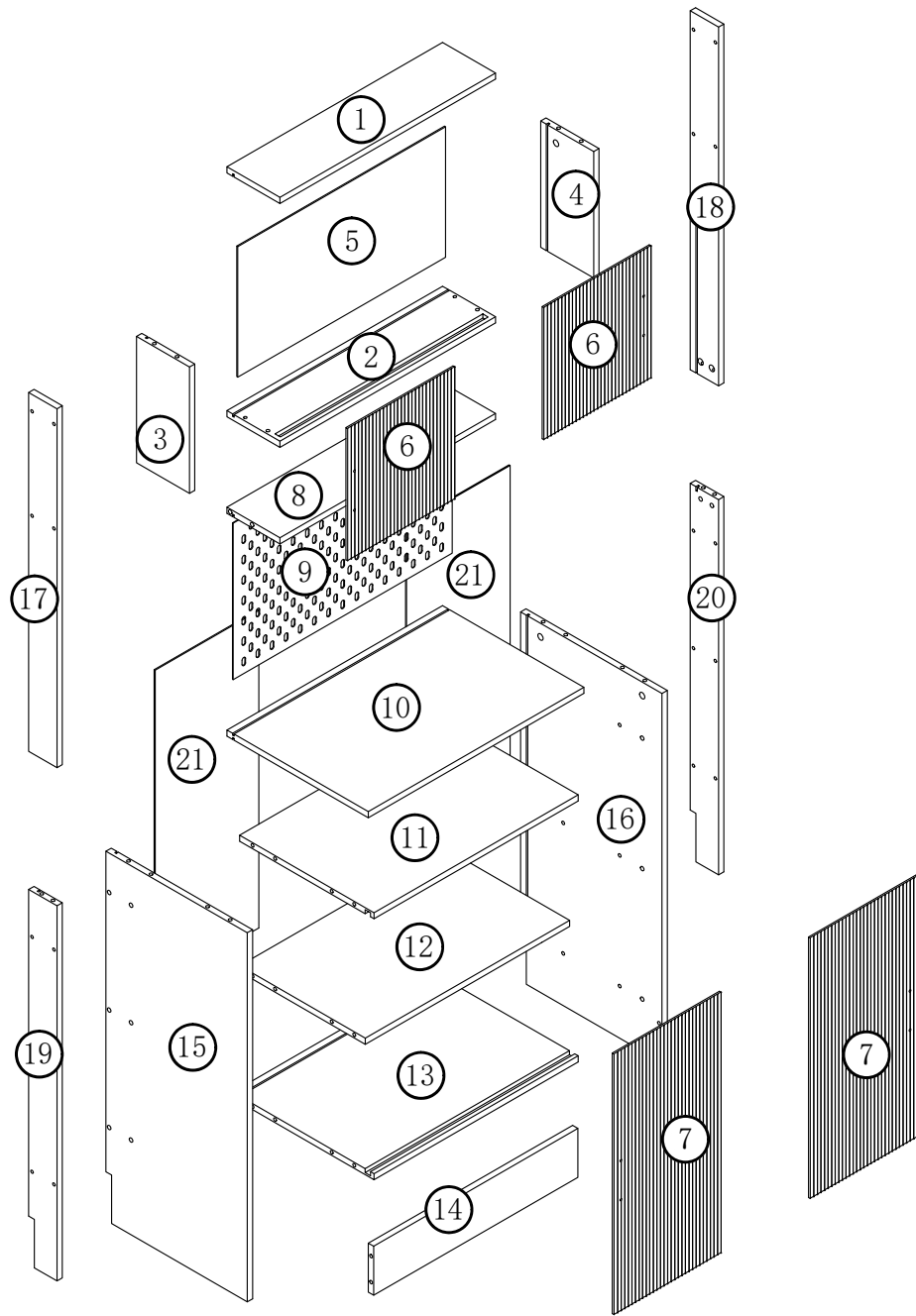







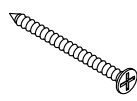
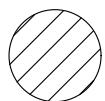

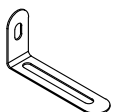

# Installation & Assembly

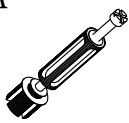

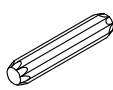
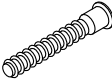

O	6*60  4PCS	P	8*40  2PCS	Q	4*50  2PCS								
H	 40PCS	I	96  4PCS	J	4*8  8PCS	K	6*25  24PCS	L	768  1PC	M	 2PCS	N	10*11  4PCS
A	 20PCS	B	 24PCS	C	8*40  22PCS	D	7*50  2PCS	E	3.5*14  2PCS	F	 10PCS	G	3*12  10PCS

1

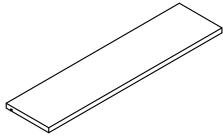

610\*150 (mm)  
24.02\*5.91 (inch)  
1PC

2

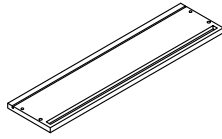

610\*150 (mm)  
24.02\*5.91 (inch)  
1PC

3



310\*150 (mm)  
12.2\*5.91 (inch)  
1PC

4

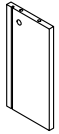

310\*150 (mm)  
12.2\*5.91 (inch)  
1PC

5

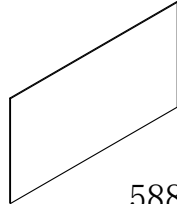

588\*320 (mm)  
23.15\*12.6 (inch)  
1PC

6

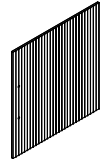

324\*303 (mm)  
12.76\*11.93 (inch)  
2PCS

7

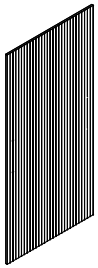

639\*303 (mm)  
25.16\*11.93 (inch)  
2PCS

8

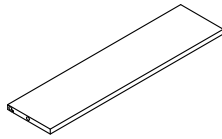

610\*150 (mm)  
24.02\*5.91 (inch)  
1PC

9

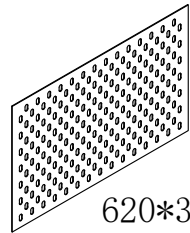

620\*383.5 (mm)  
24.41\*15.1 (inch)  
1PC

10

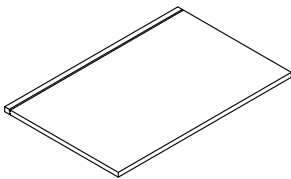

610\*400 (mm)  
24.02\*15.75 (inch)  
1PC

11

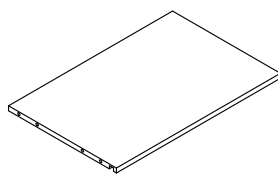

578\*380 (mm)  
22.76\*14.96 (inch)  
1PC

12

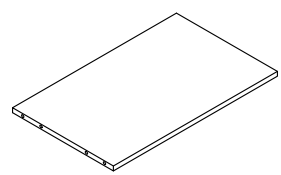

578\*355.5 (mm)  
22.76\*14 (inch)  
1PC

13

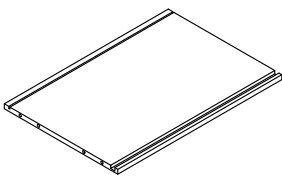

578\*400 (mm)  
22.76\*15.75 (inch)  
1PC

14

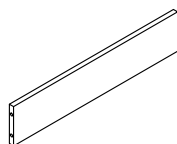

578\*120 (mm)  
22.76\*4.72 (inch)  
1PC

15

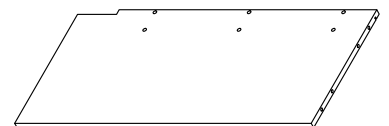

905\*400 (mm)  
35.63\*15.75 (inch)  
1PC

16

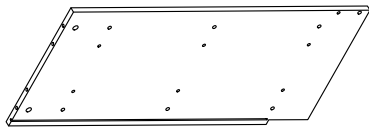

905\*400 (mm)  
35.63\*15.75 (inch)  
1PC

17

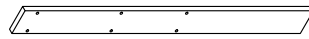

880\*80 (mm)  
34.65\*3.15 (inch)  
1PC

18

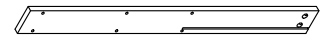

880\*80 (mm)  
34.65\*3.15 (inch)  
1PC

19

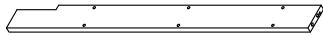

920\*80 (mm)  
36.22\*3.15 (inch)  
1PC

20



920\*80 (mm)  
36.22\*3.15 (inch)  
1PC

21



778.5\*293 (mm)  
30.65\*11.54 (inch)  
2PCS

### Hardware installation demonstration

NOTE: Please make sure "A" hardware tightened and can't be pulled out!

I

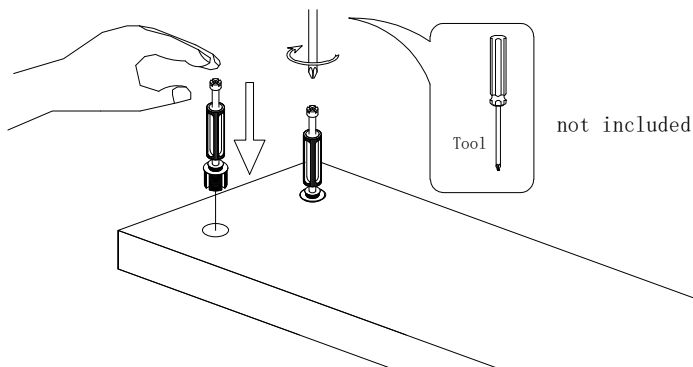

II

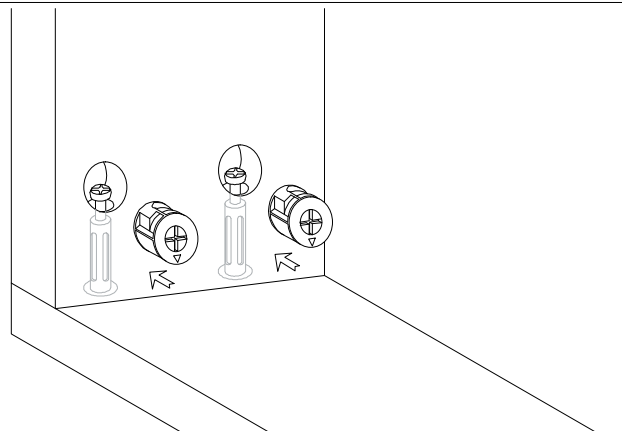

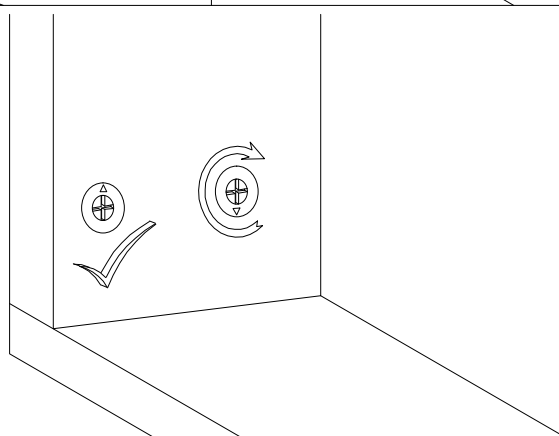

III

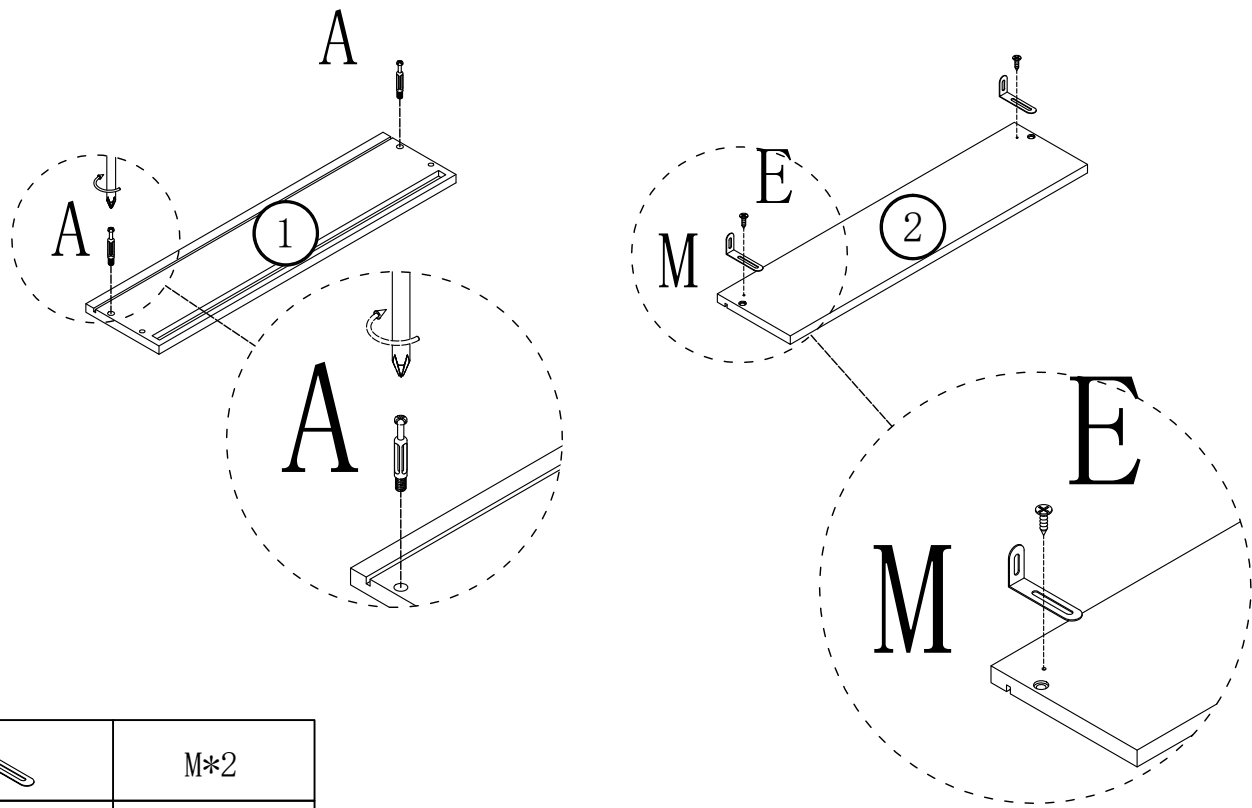

1





	M*2
	E*2
	A*2

Put A on board ①

Put M、E on board ②

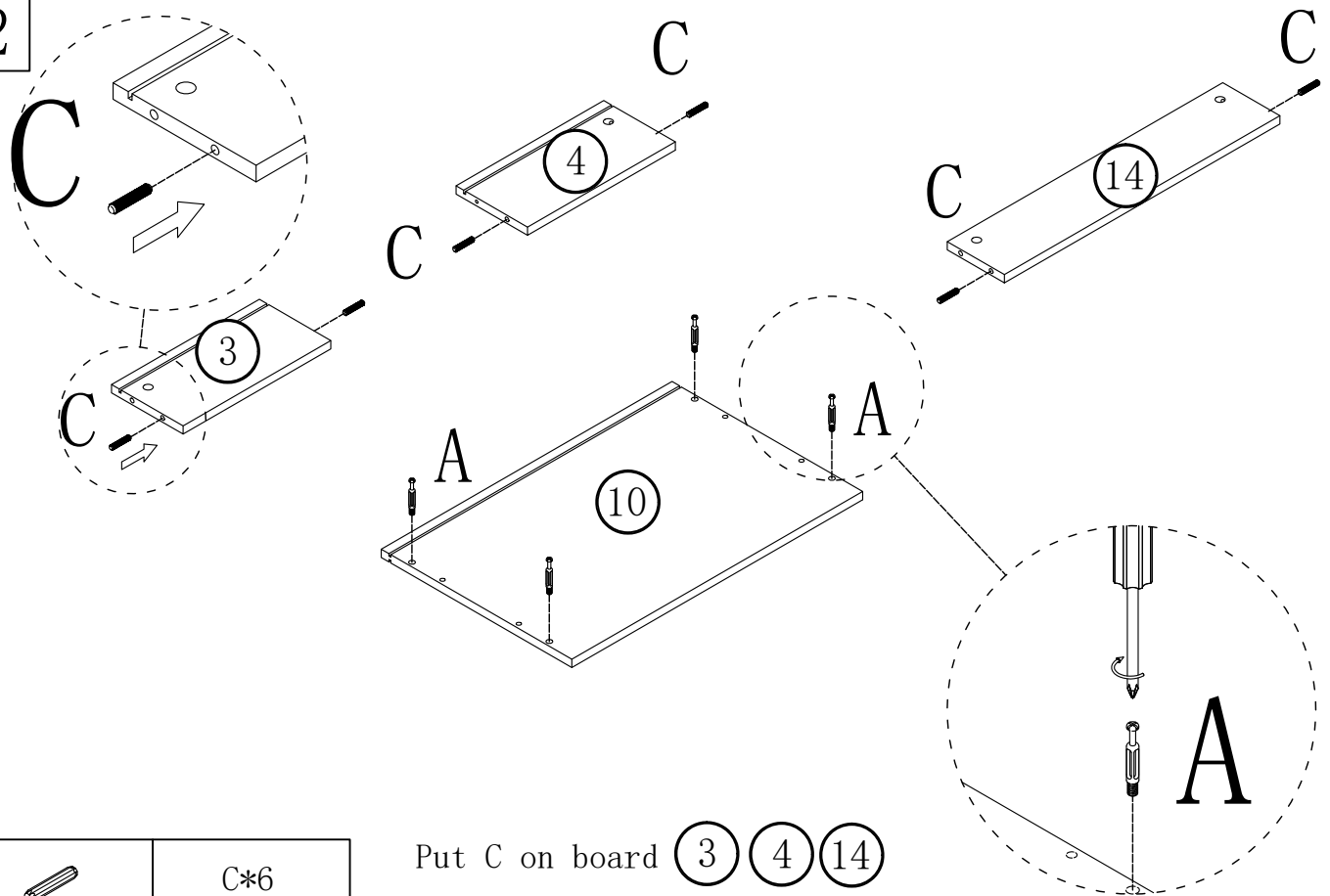
2



	C*6
	A*4



Put C on board ③ ④ ⑭

Put A on board ⑩

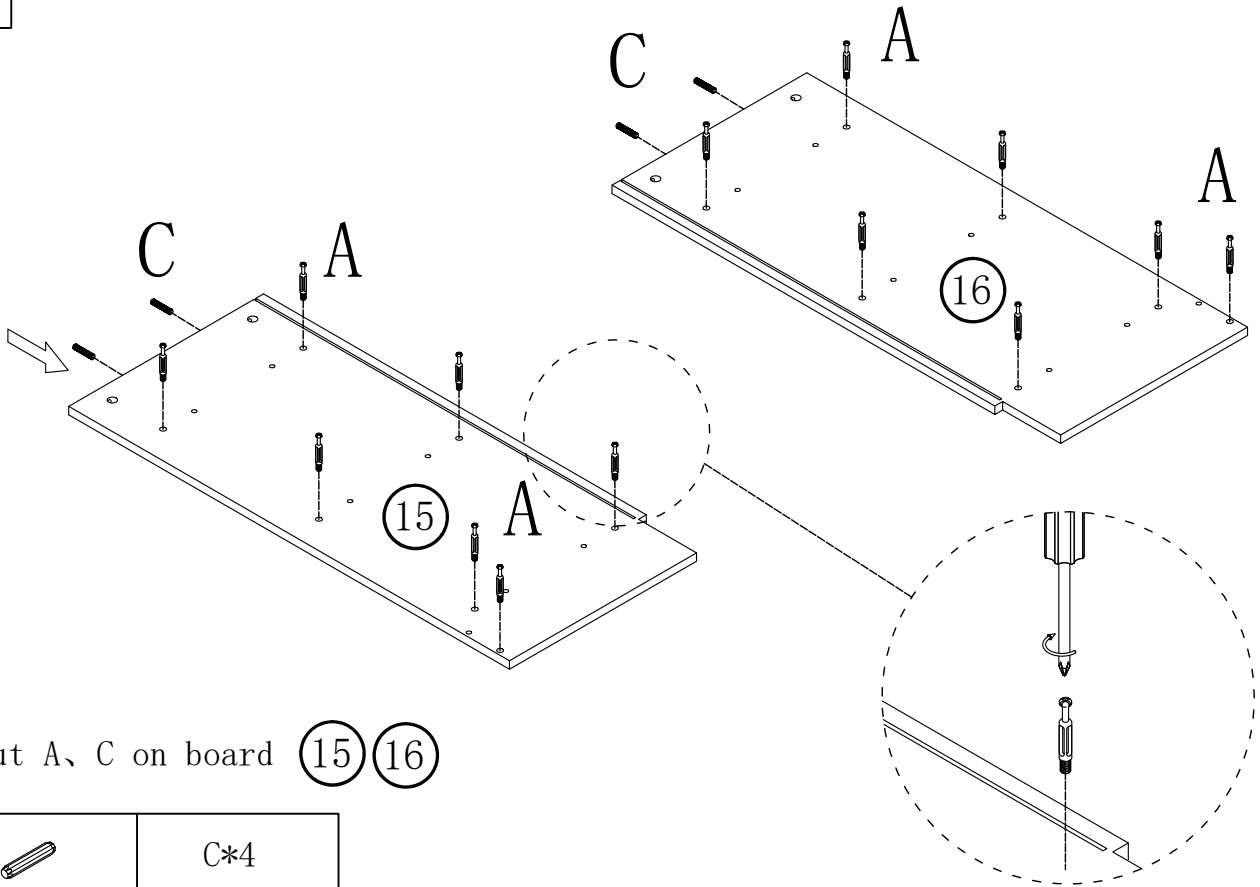
3



Put A, C on board 15 16

	C*4
	A*14

4

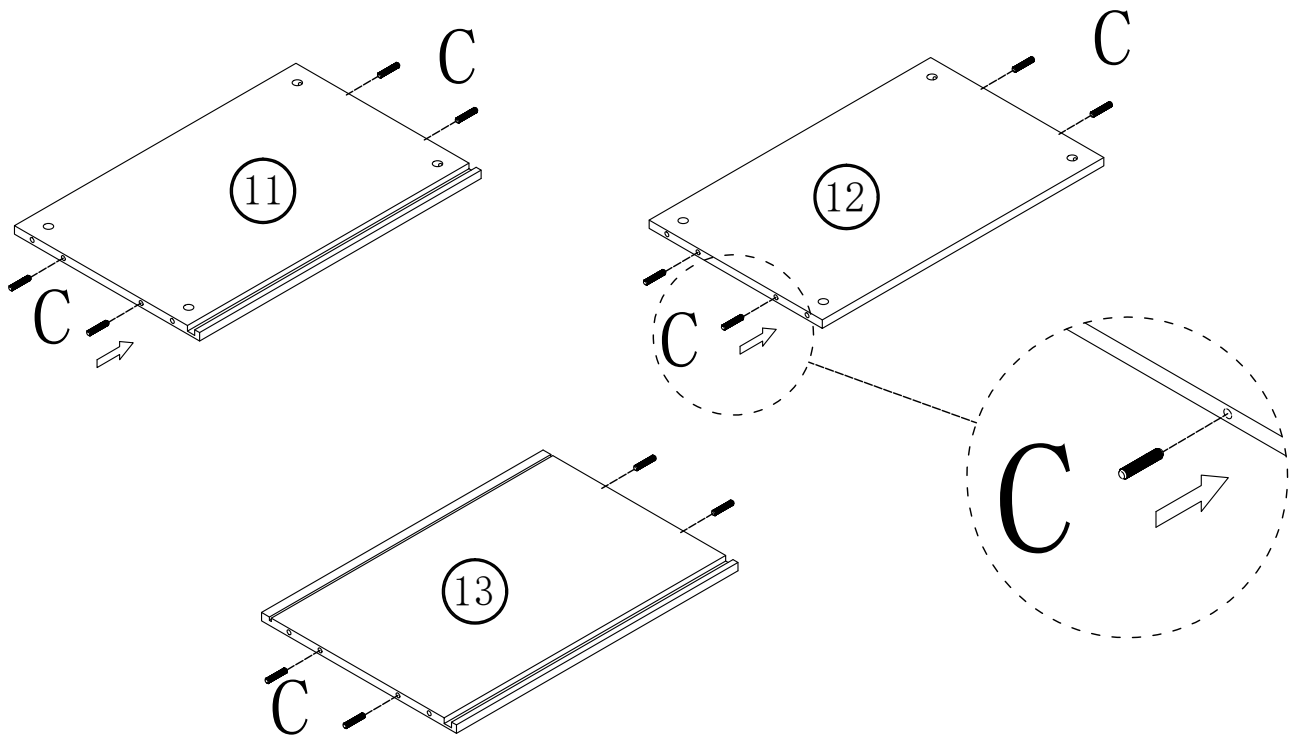



Put C on board 11 12 13

	C*12
---	------

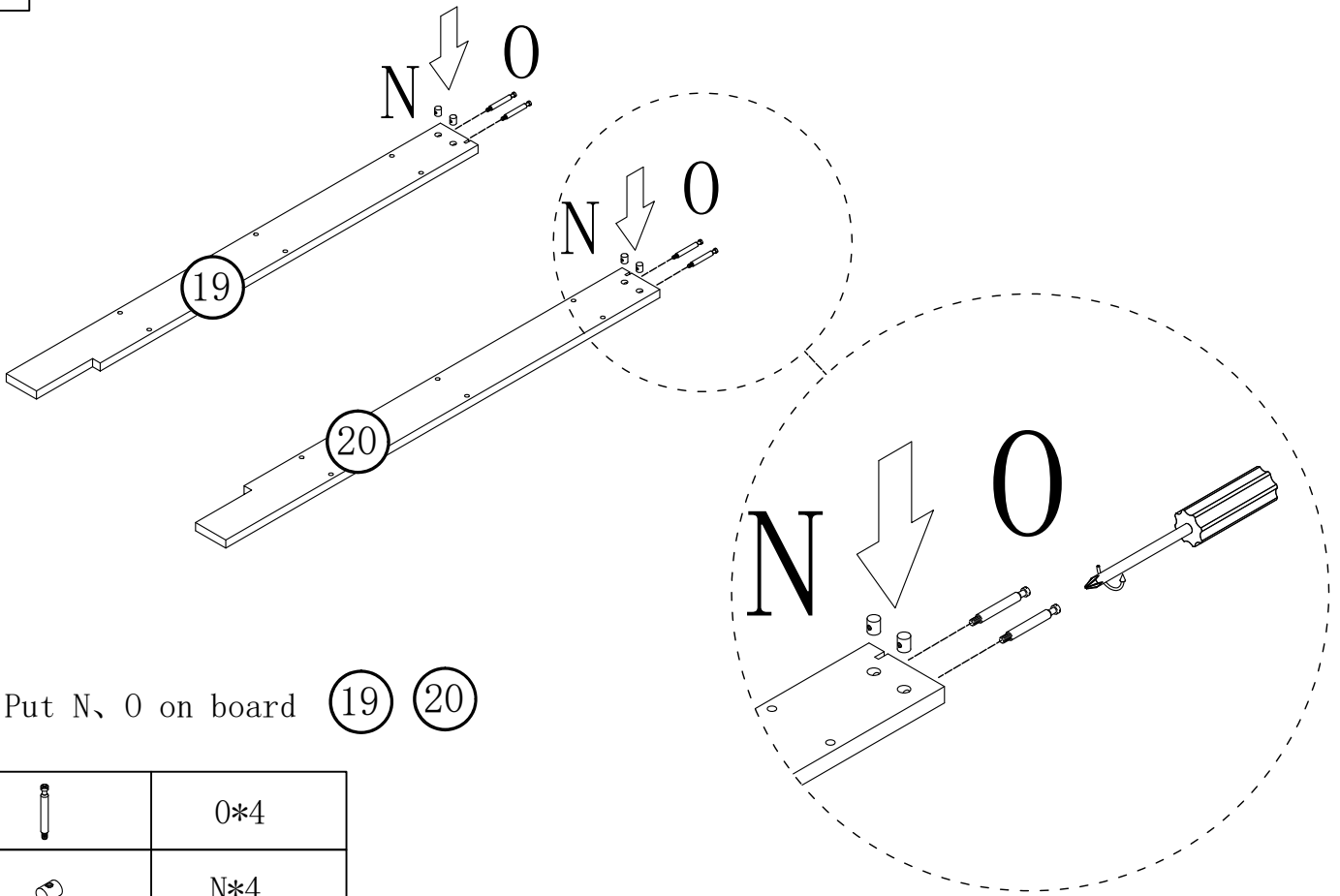
5



Put N, O on board 19 20

	O*4
	N*4

6

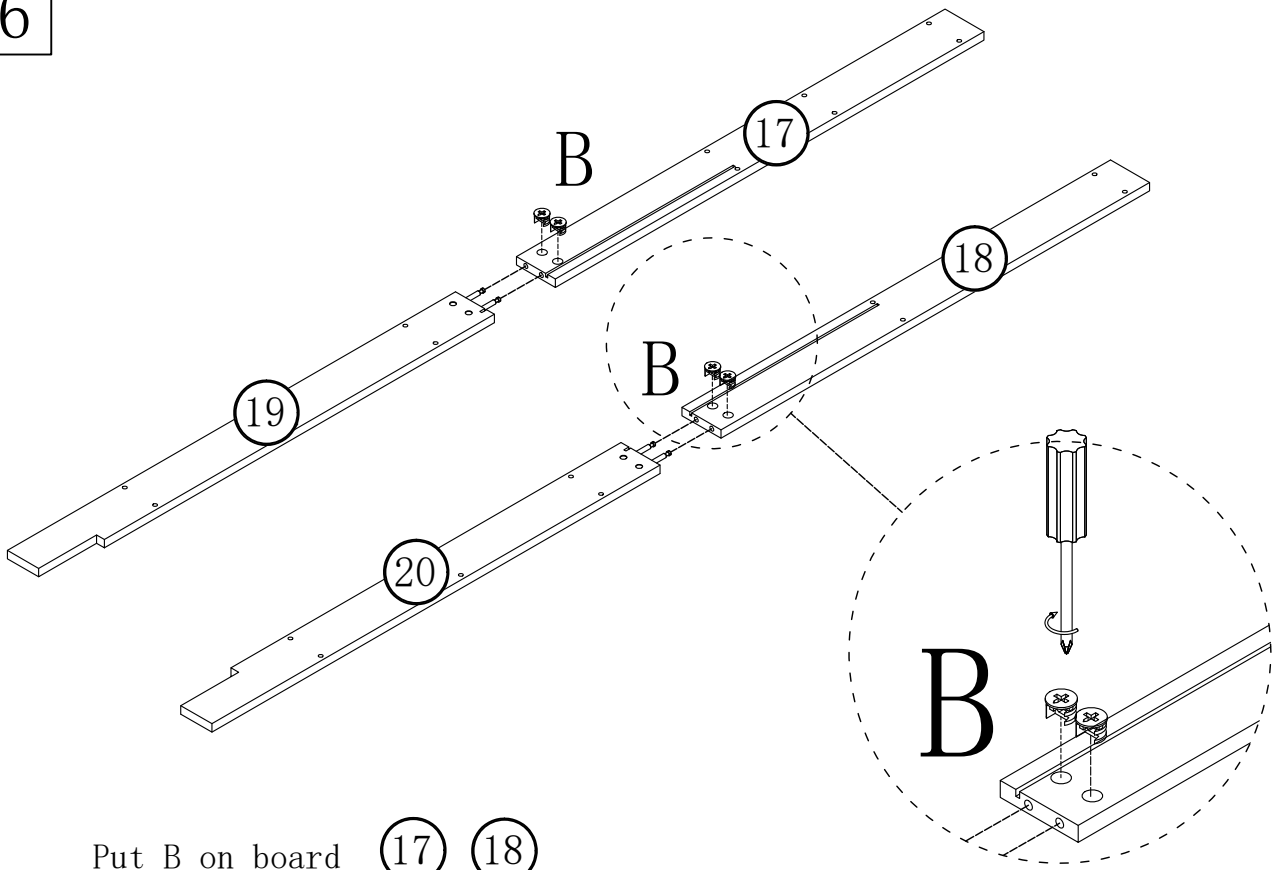





Put B on board 17 18

	B*4
---	-----

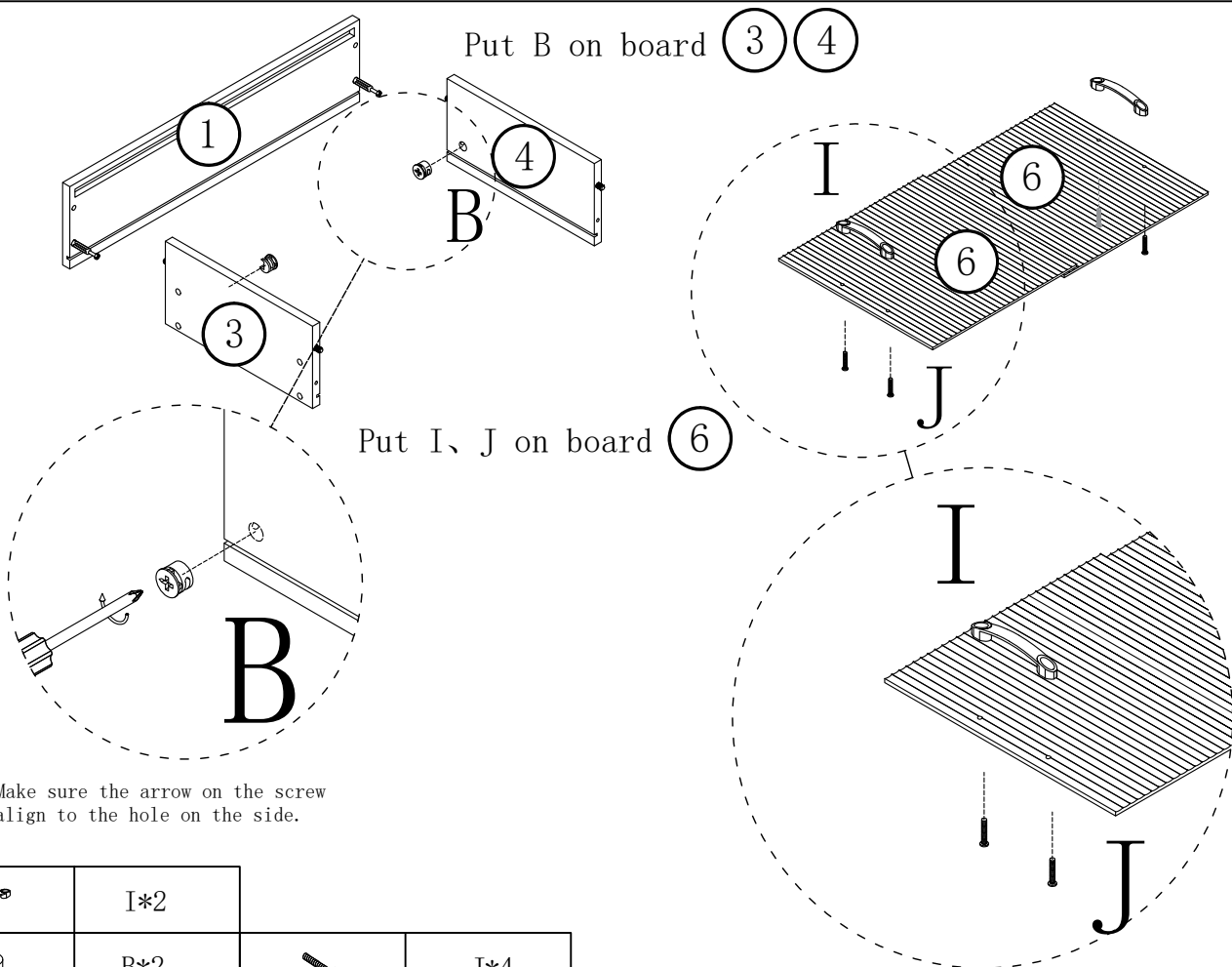
Make sure the arrow on the screw align to the hole on the side.

7



	I*2		
	B*2		J*4

8

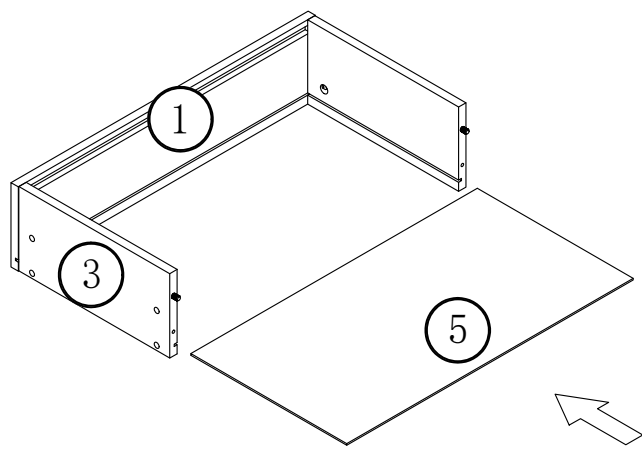

9

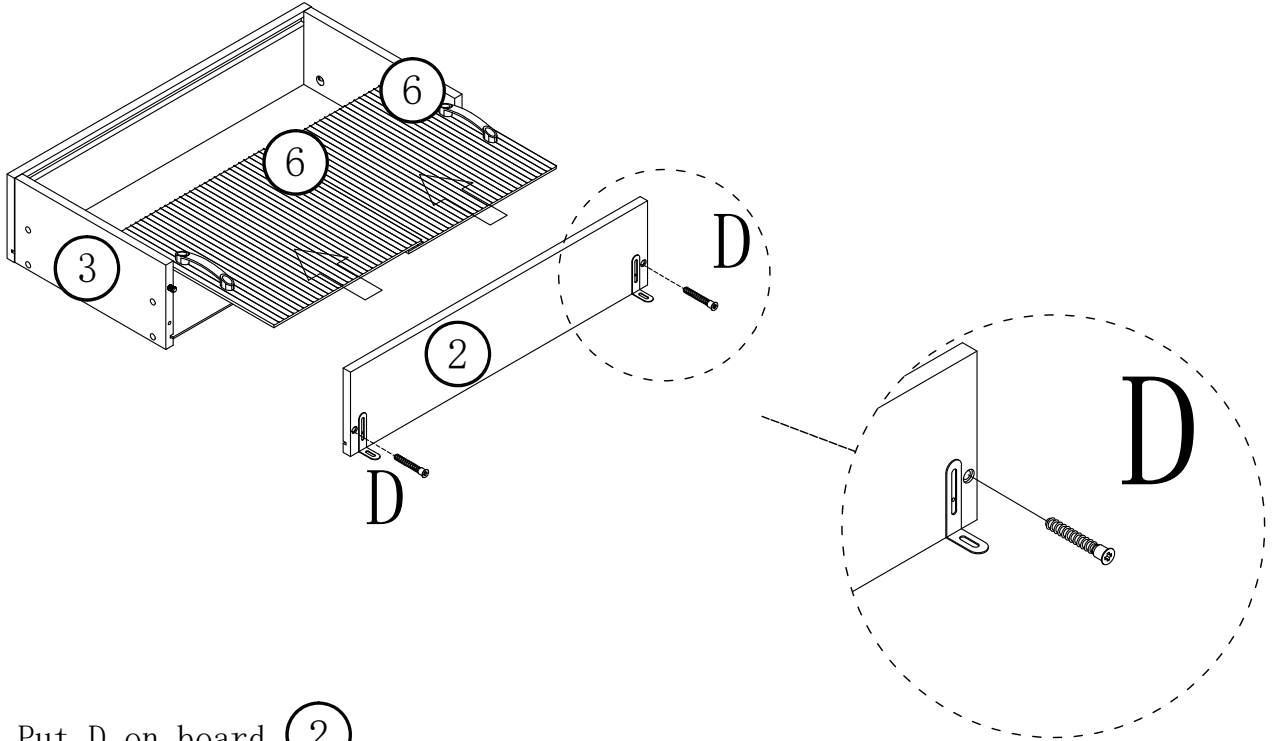

Put D on board ②

	D*2
---	-----

10

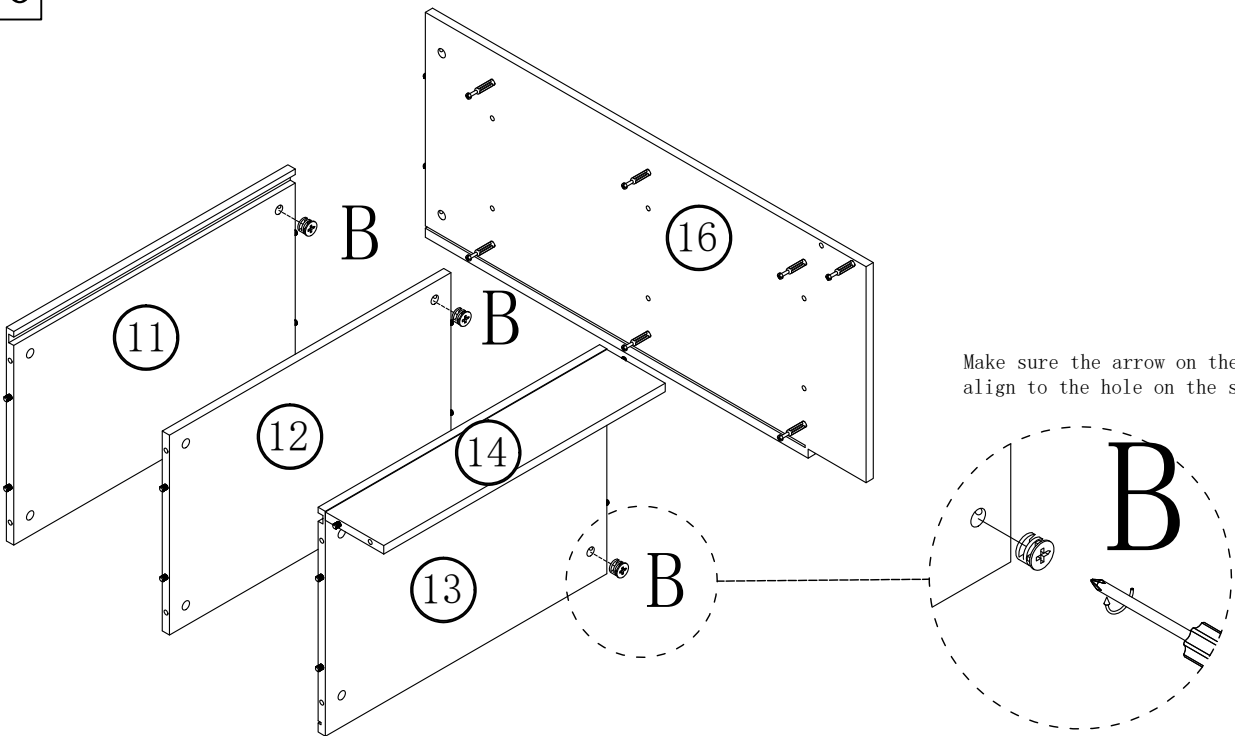

Make sure the arrow on the screw align to the hole on the side.



Put B on board ①① ①② ①③ ①④

	B*7
---	-----

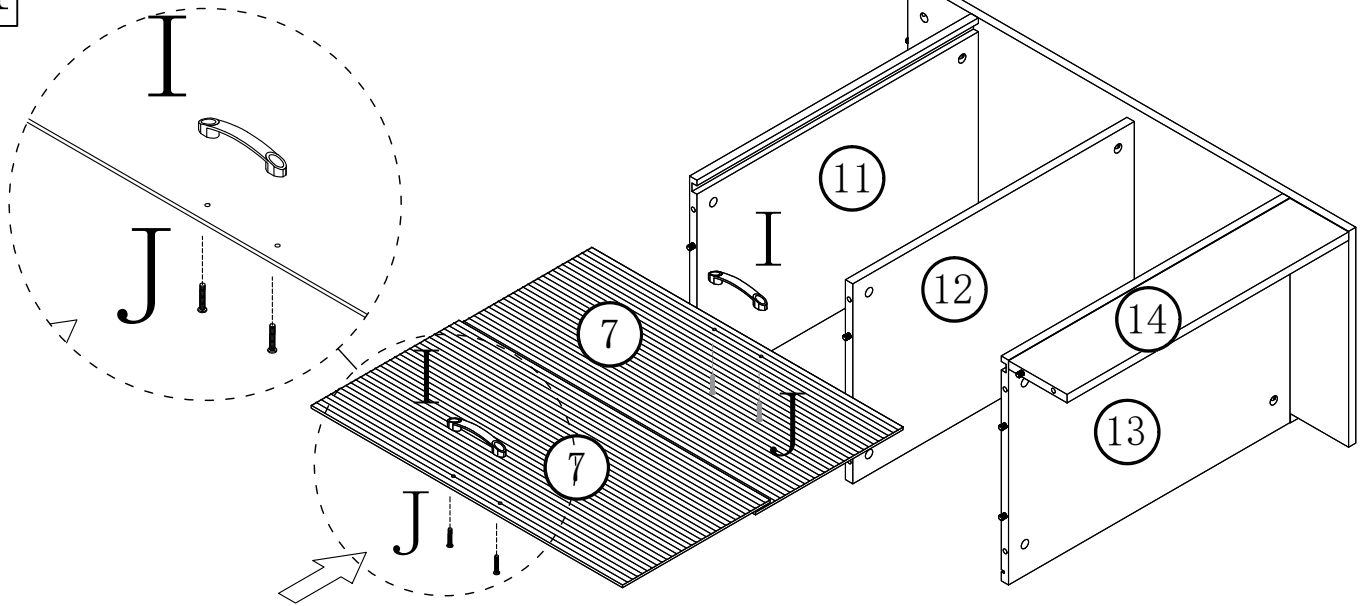
11



Put I、J on board (7)

	I*2
	J*4

12

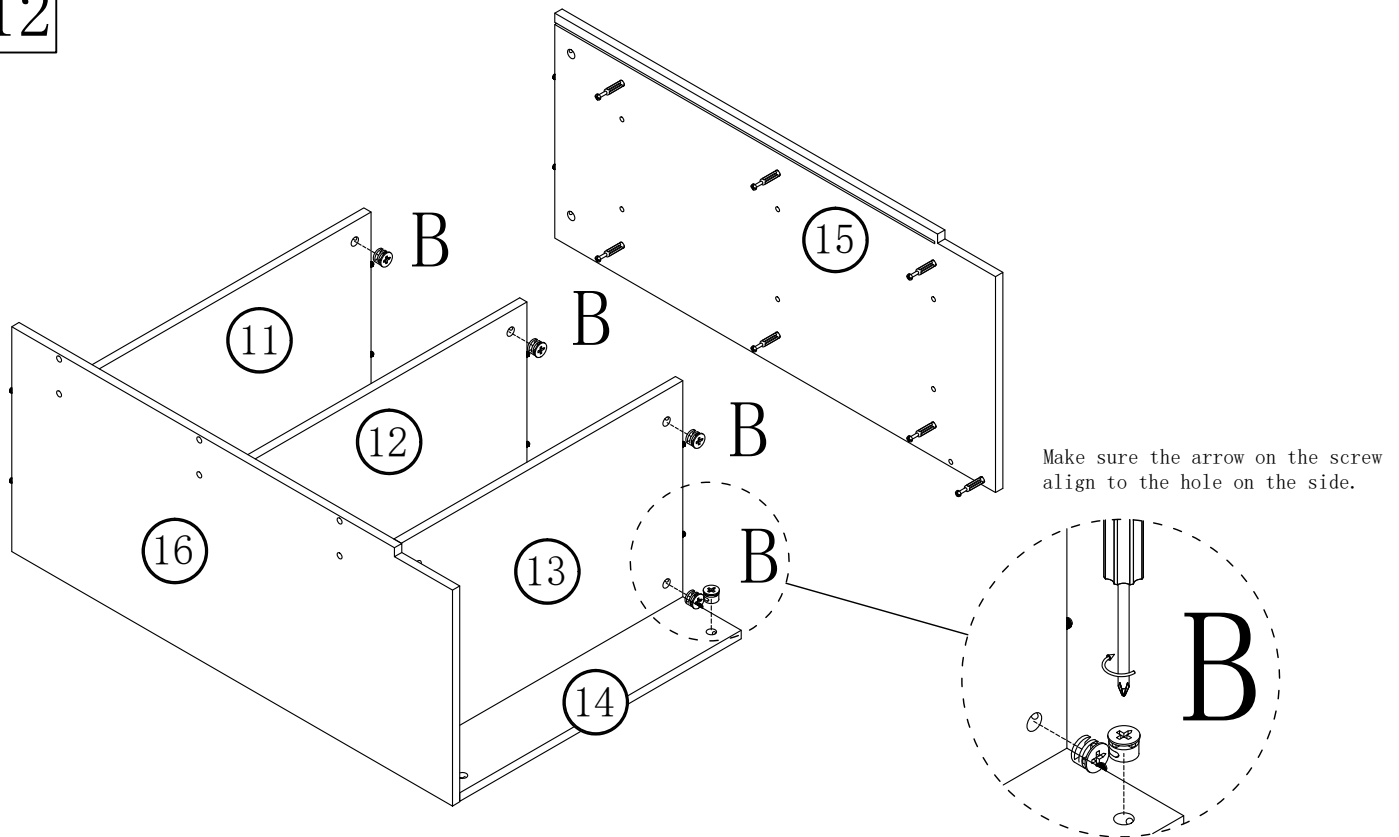

Put B on board (11) (12) (13) (14)

	B*7
---	-----

13

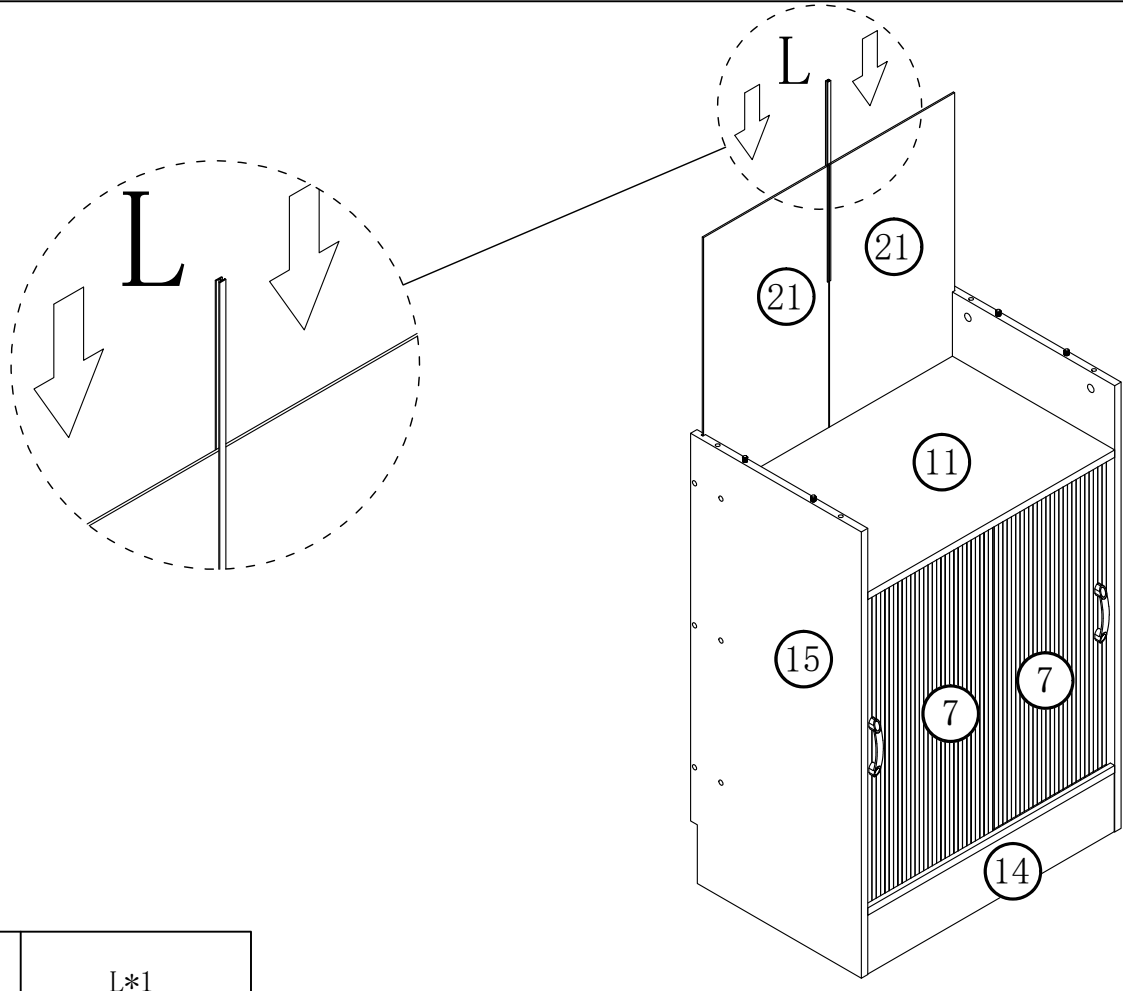

	L*1
---	-----

14

Make sure the arrow on the screw align to the hole on the side.

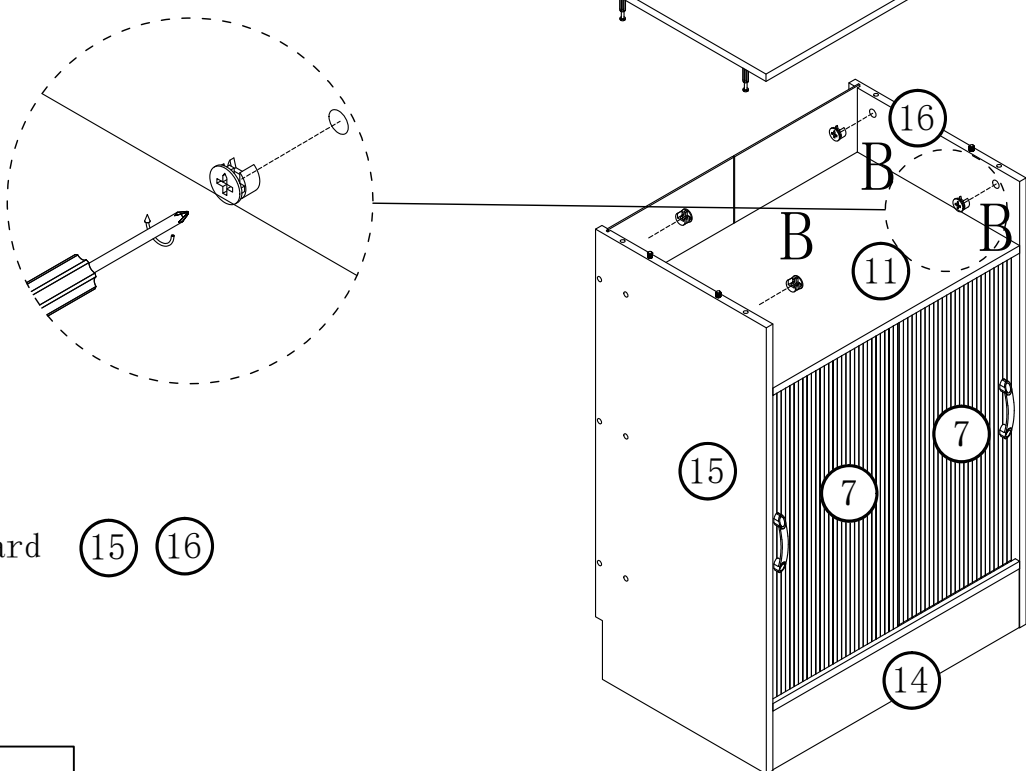

Put B on board  

	B*4
---	-----

15

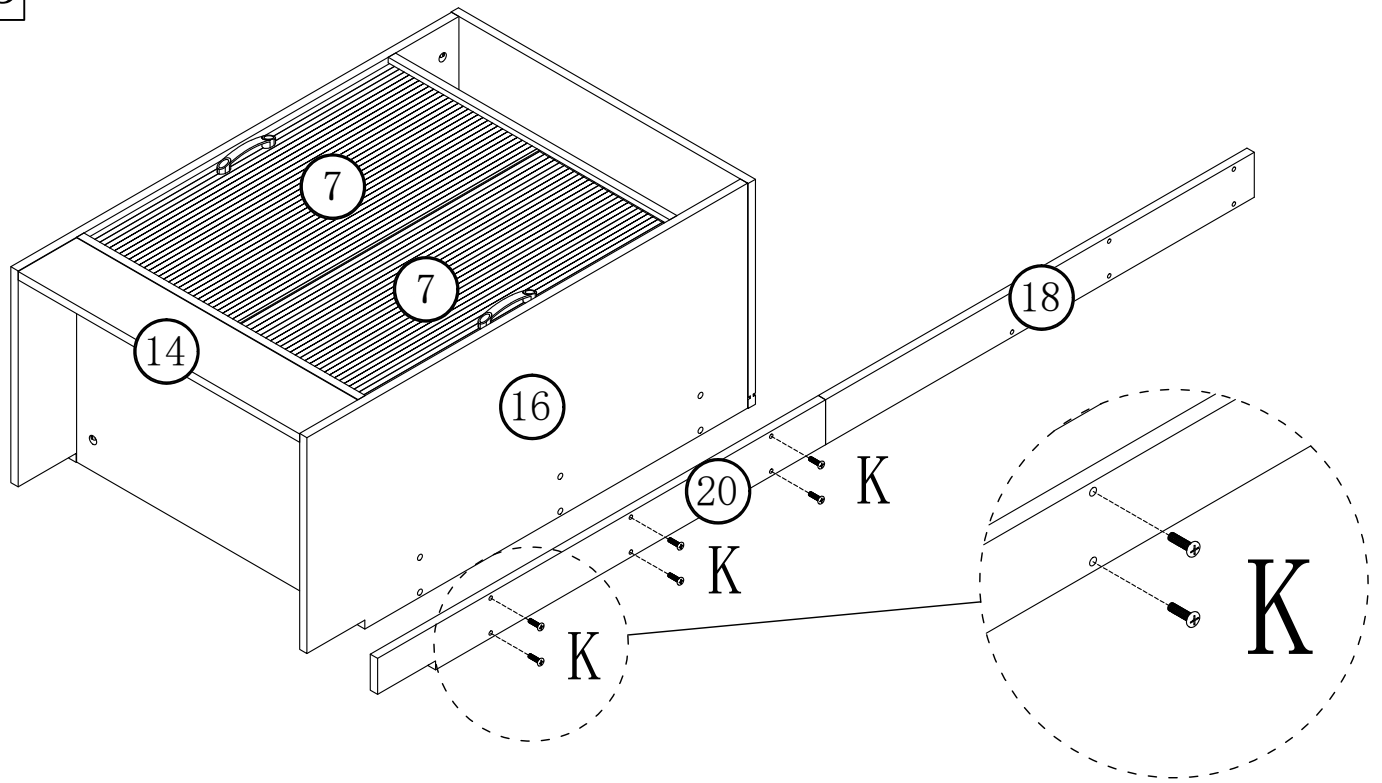

Put K on board (20)



16

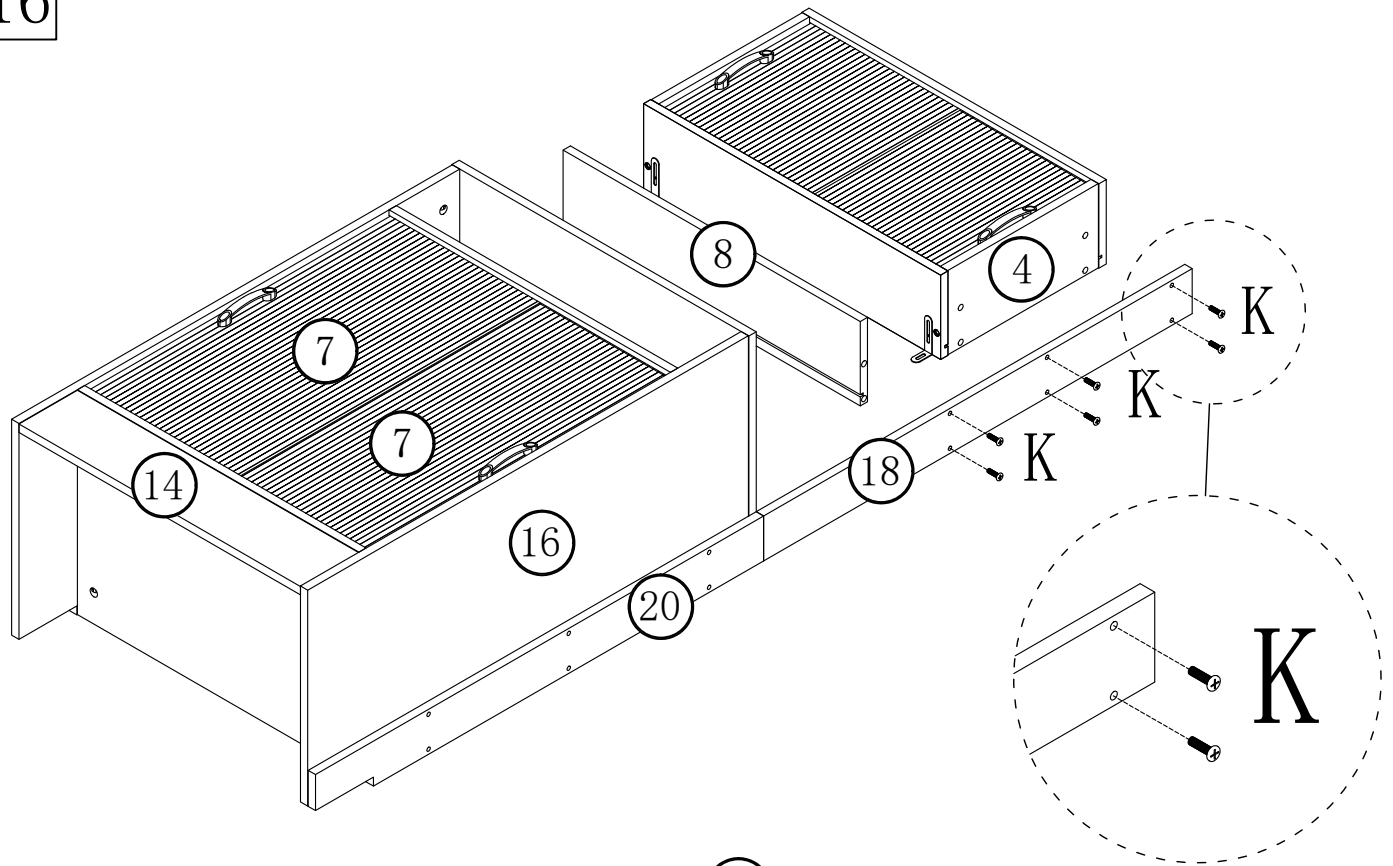

Put K on board (18)

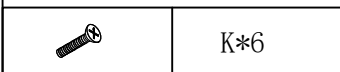

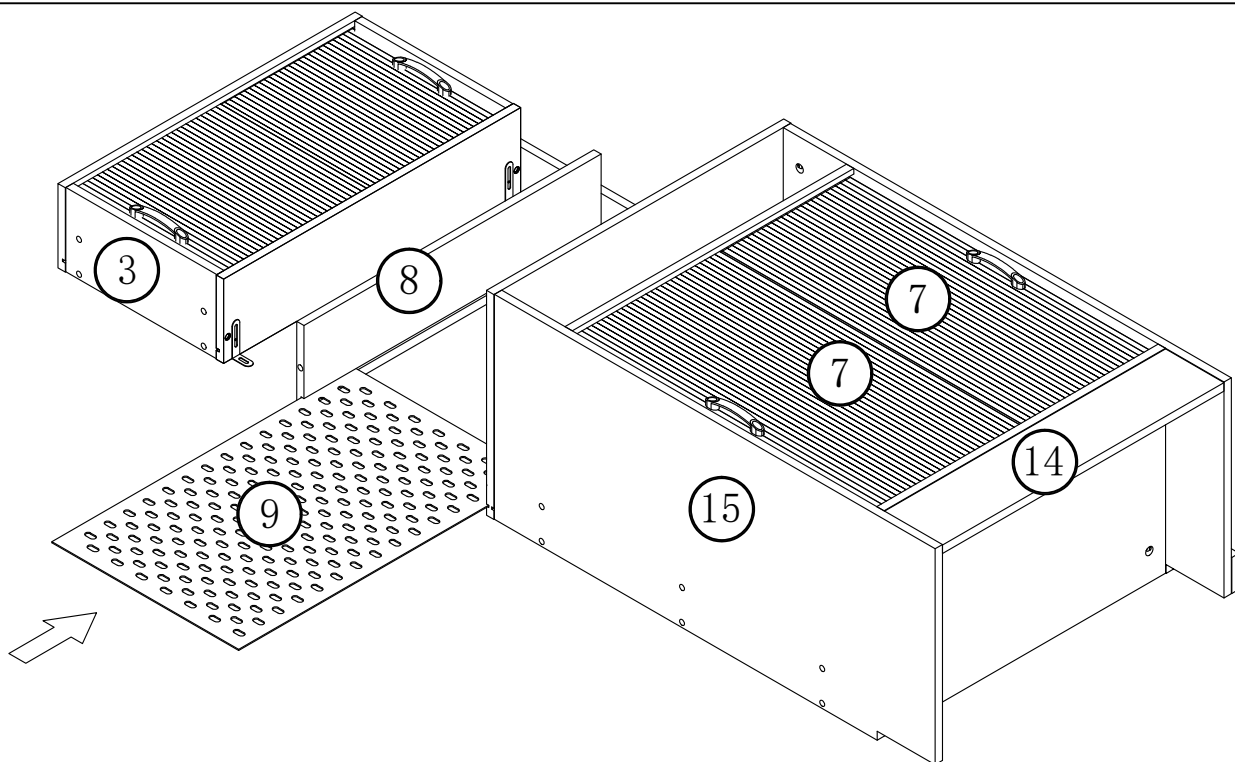

17



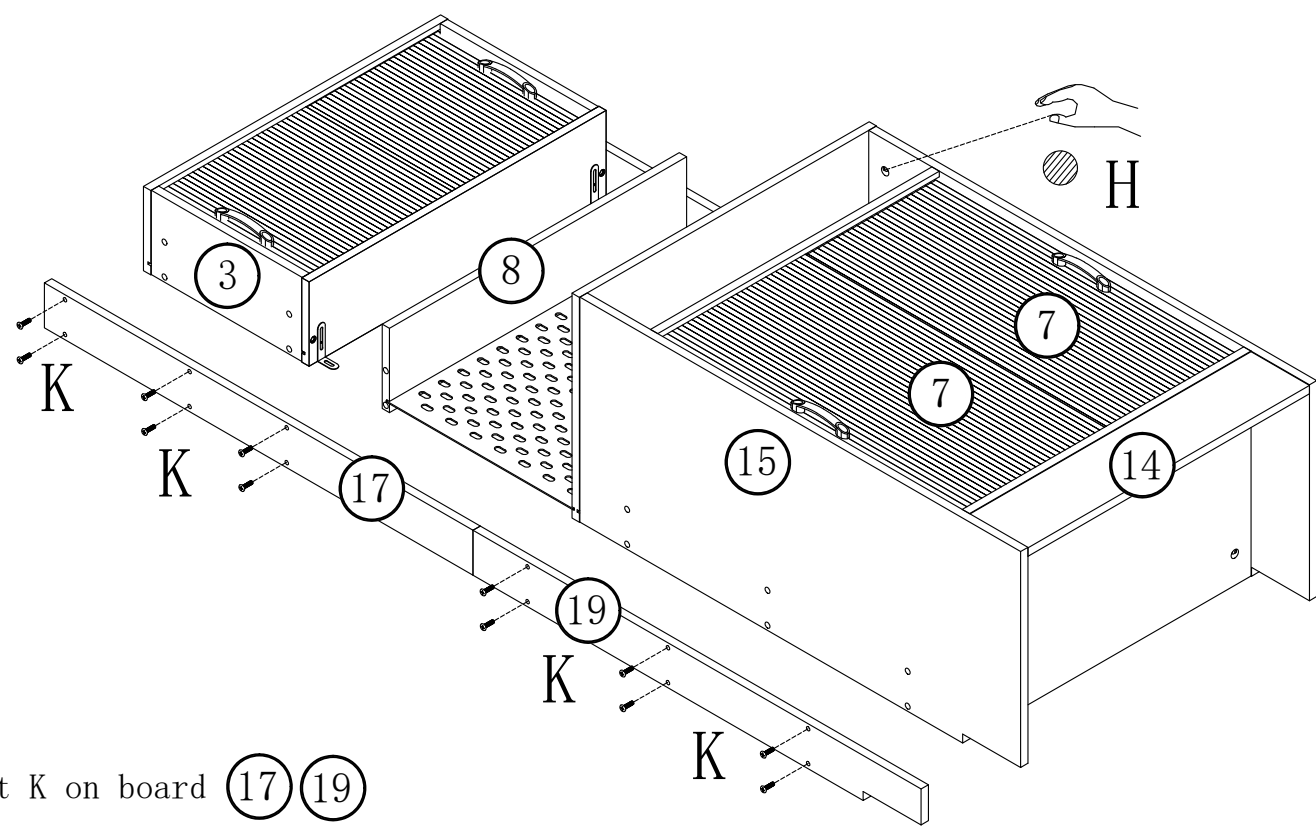

18



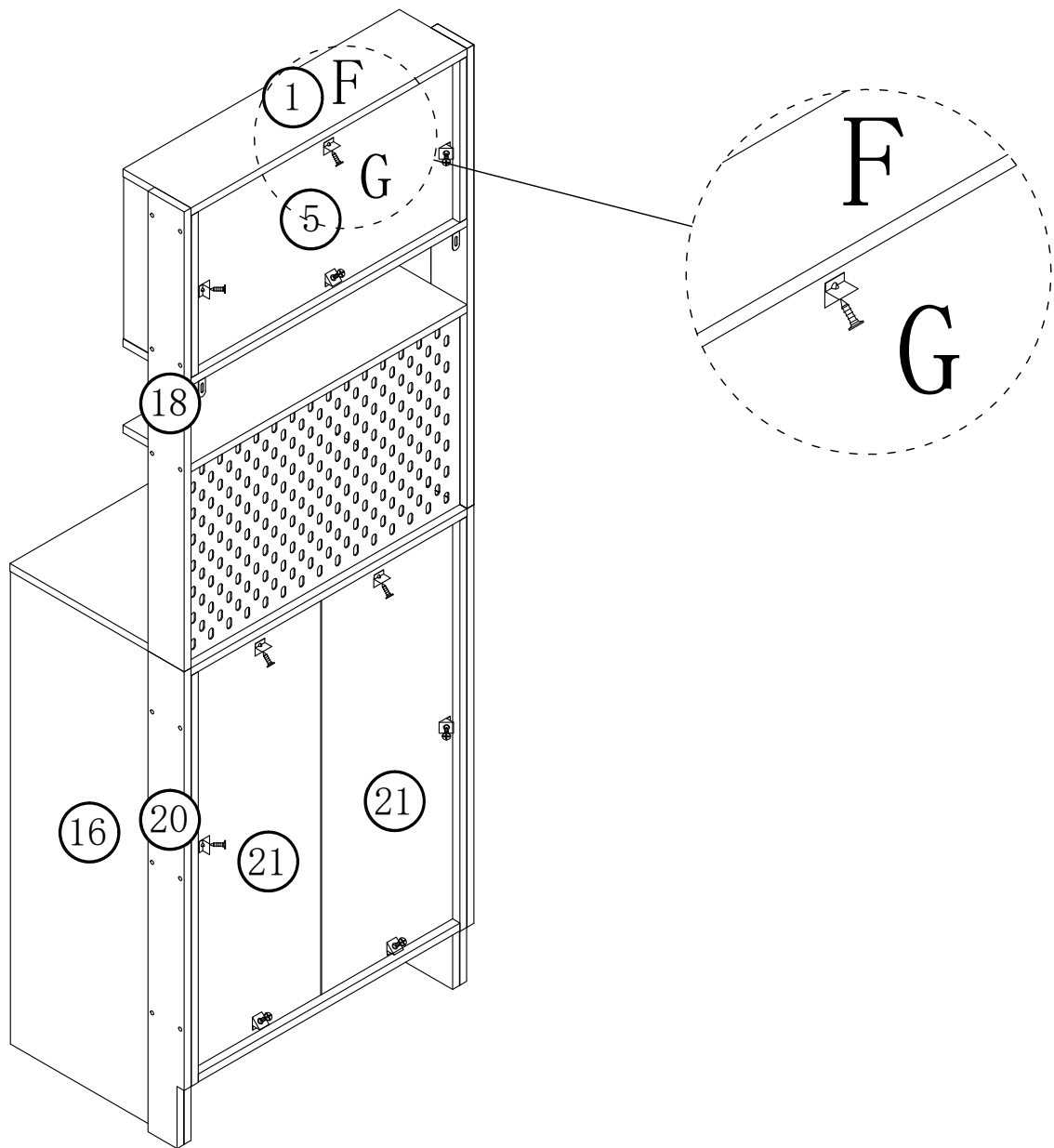

Put K on board (17) (19)

	H*40
	K*12

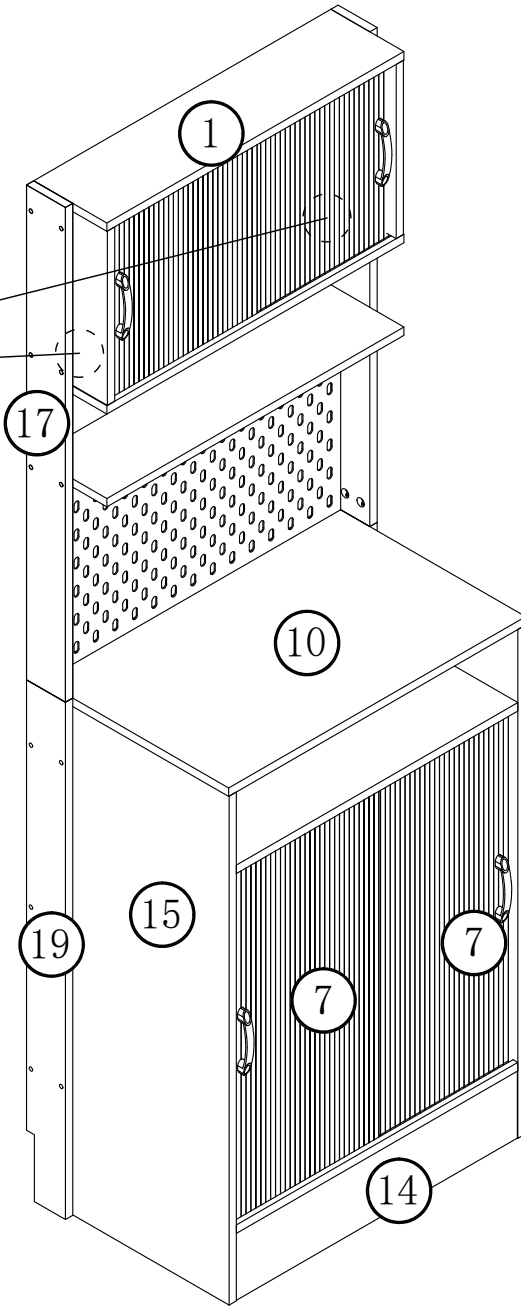
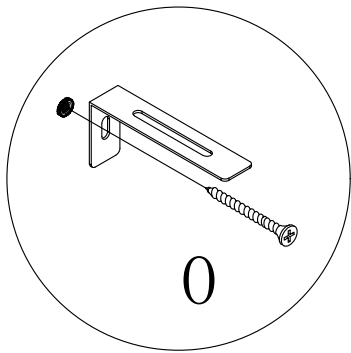
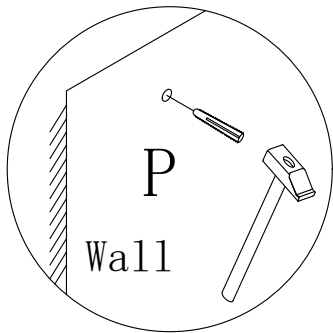
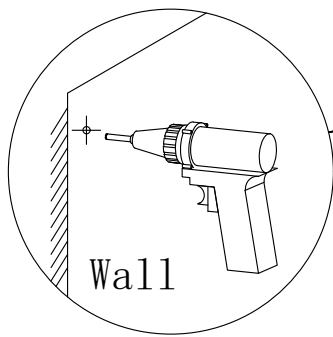

	G*10
	F*10



	0*2
	P*2