

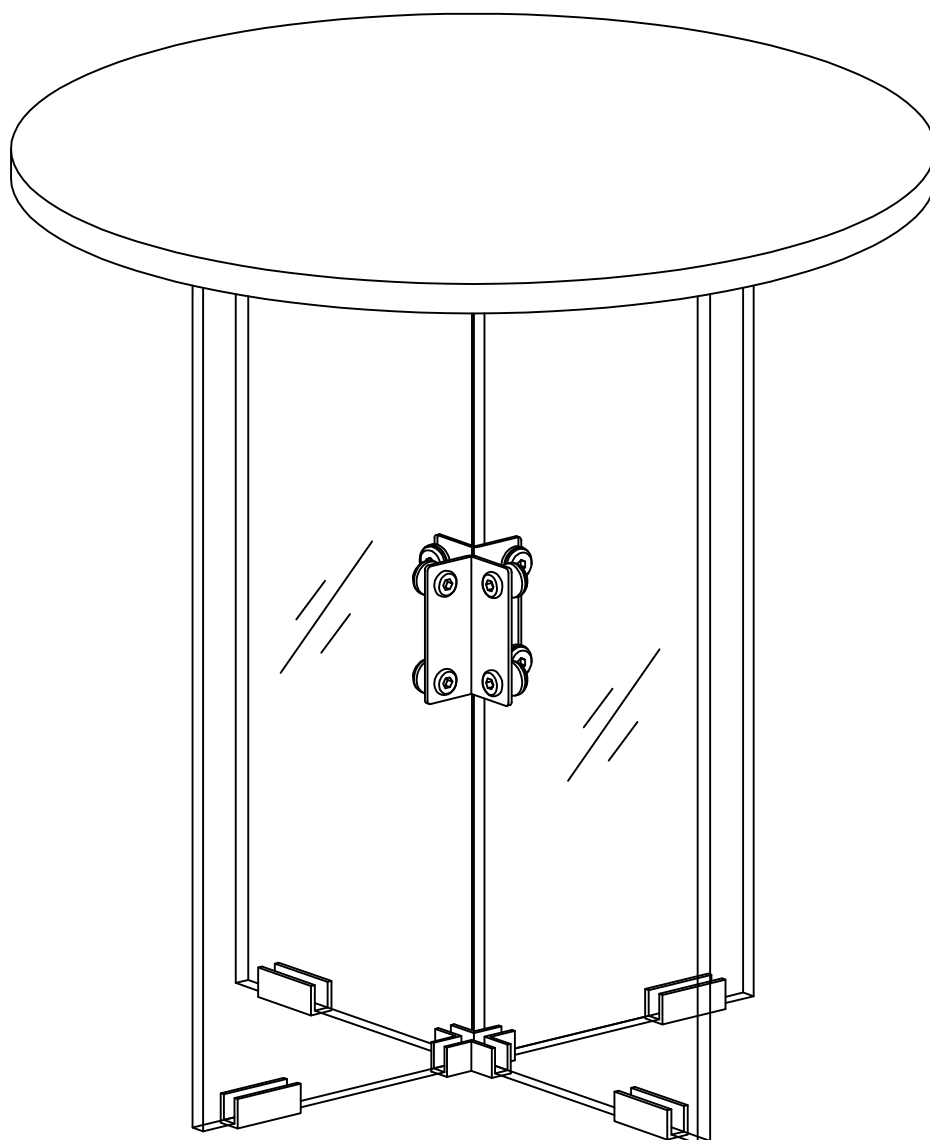

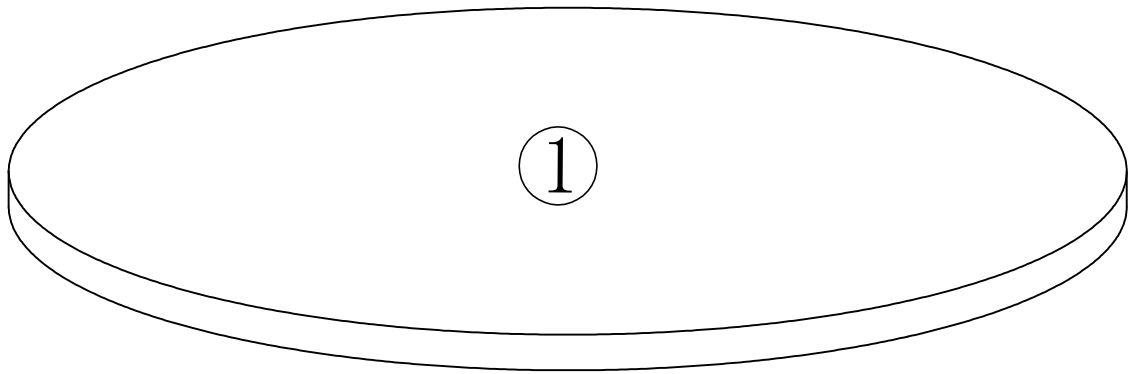







6090-ET661W



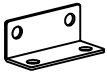
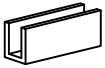

A	X16+1	B	X8+1	C	X16	D	X16	E	X2
									
M6*8mm		M6*12mm		∅ 17mm		M6*10mm		M4X55mm	

F	X6	G	X4	H	X1	I	X2	J	X1
									
70*30*30mm		L40mm		L44*44mm		450*171*8mm		450*350*8mm	





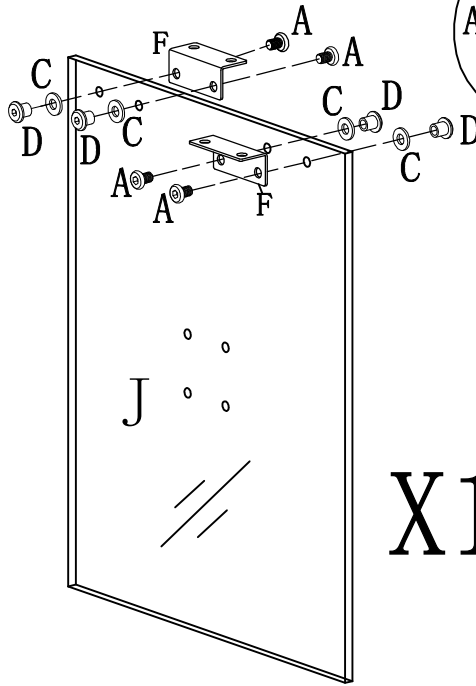
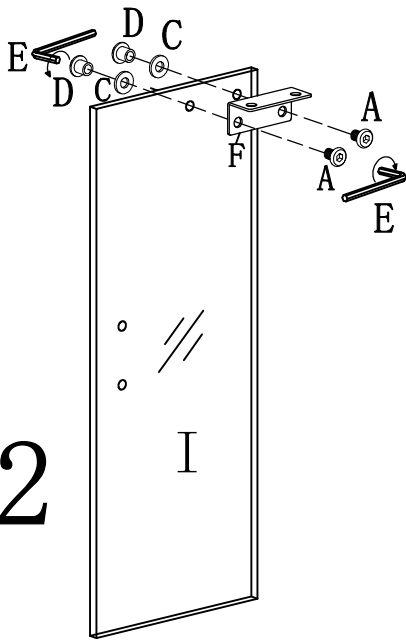

STEP 1

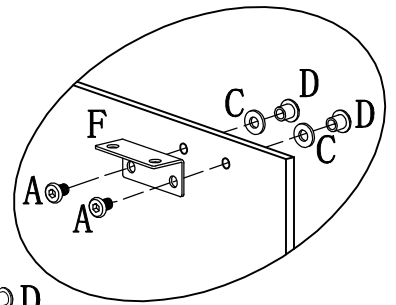
X2



X1



A	X8	C	X8	D	X8	E	X2	F	X4	I	X2	J	X1
													
M6*8mm		∅ 17mm		M6*10mm		M4X55mm		70*30*30mm		450*171*8mm		450*350*8mm	

STEP 2

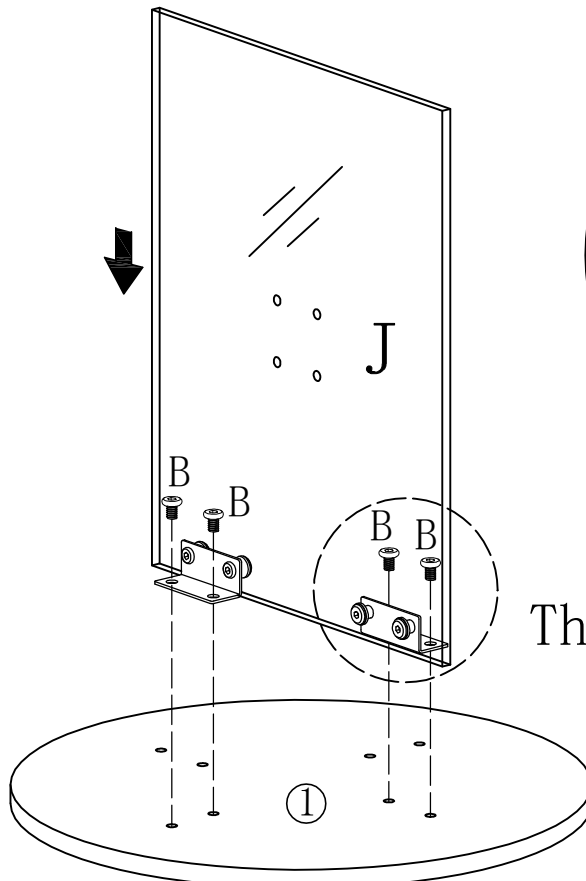



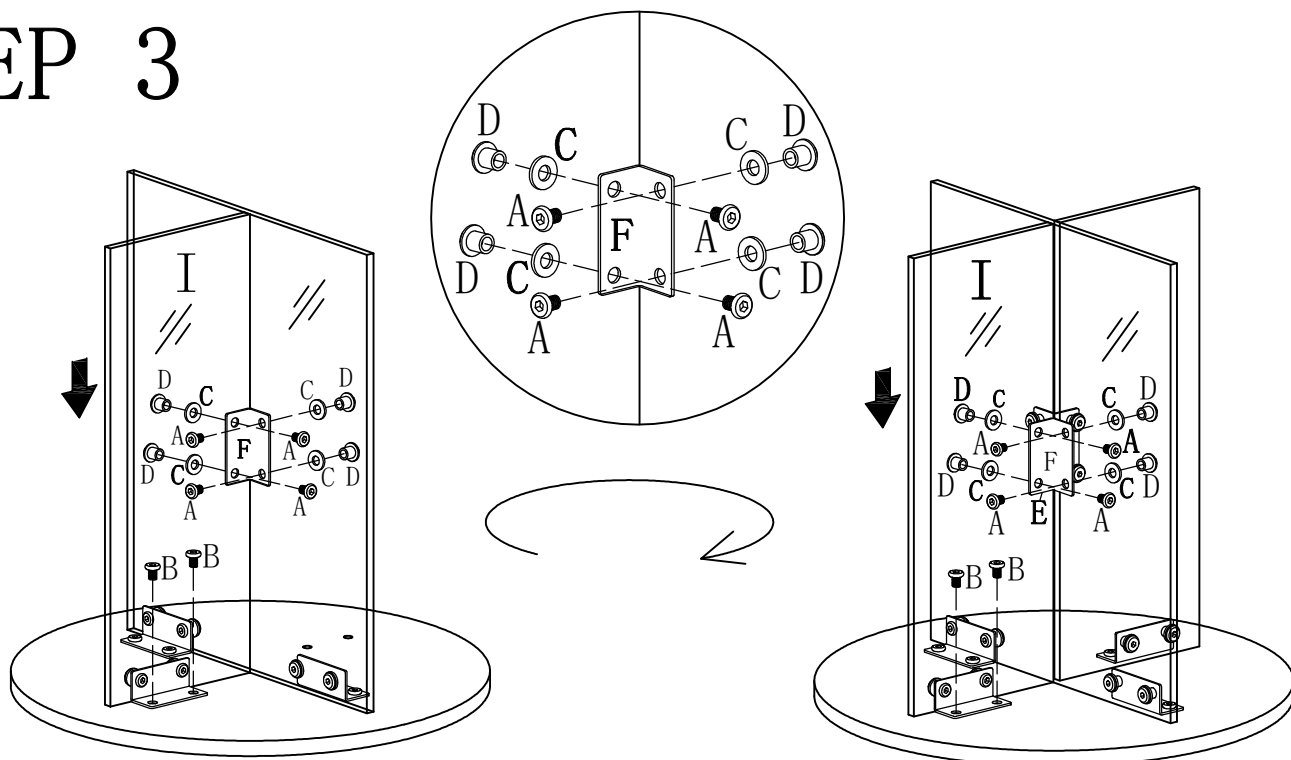

The other side

B	X4
	
M6*12mm	



STEP 3

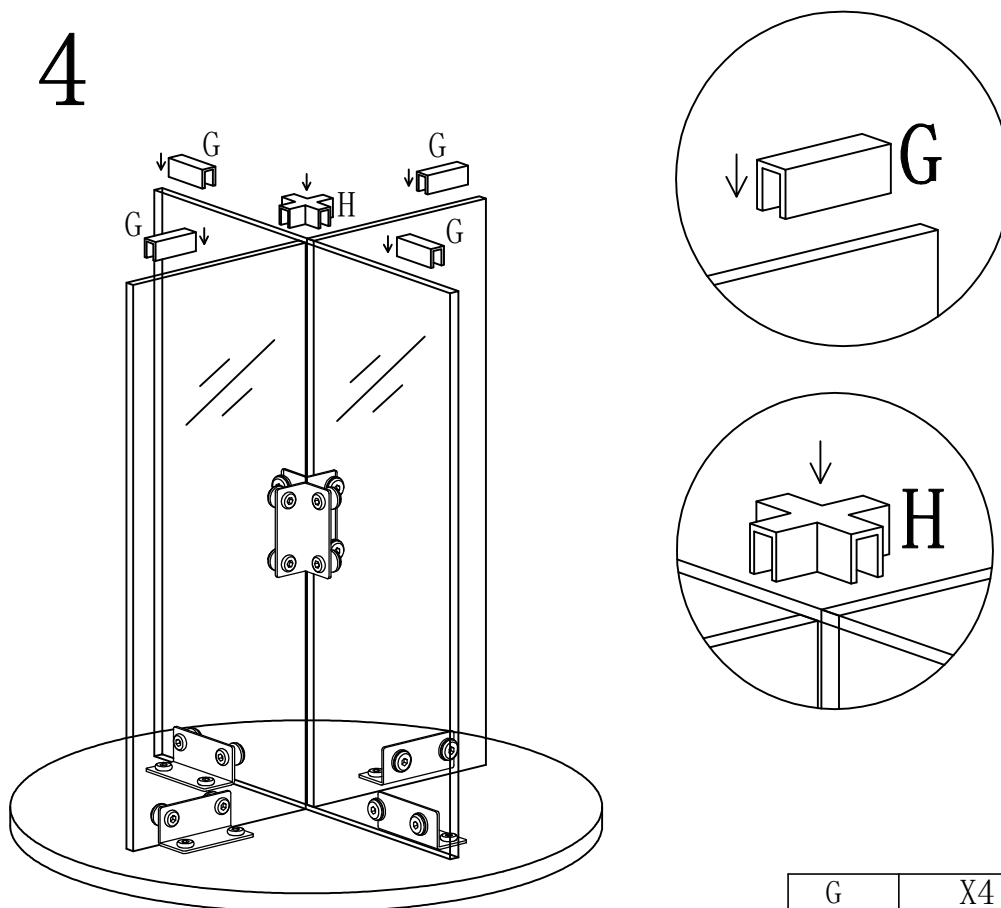

A	X8	B	X4	C	X8	D	X8	F	X2
									
M6*8mm		M6*12mm		∅ 17mm		M6*10mm		70*30*30mm	

STEP 4



G	X4	H	X1
			
L40mm		L44*44mm	