

ASSEMBLY INSTRUCTIONS

36 INCH MIRROR CABINET

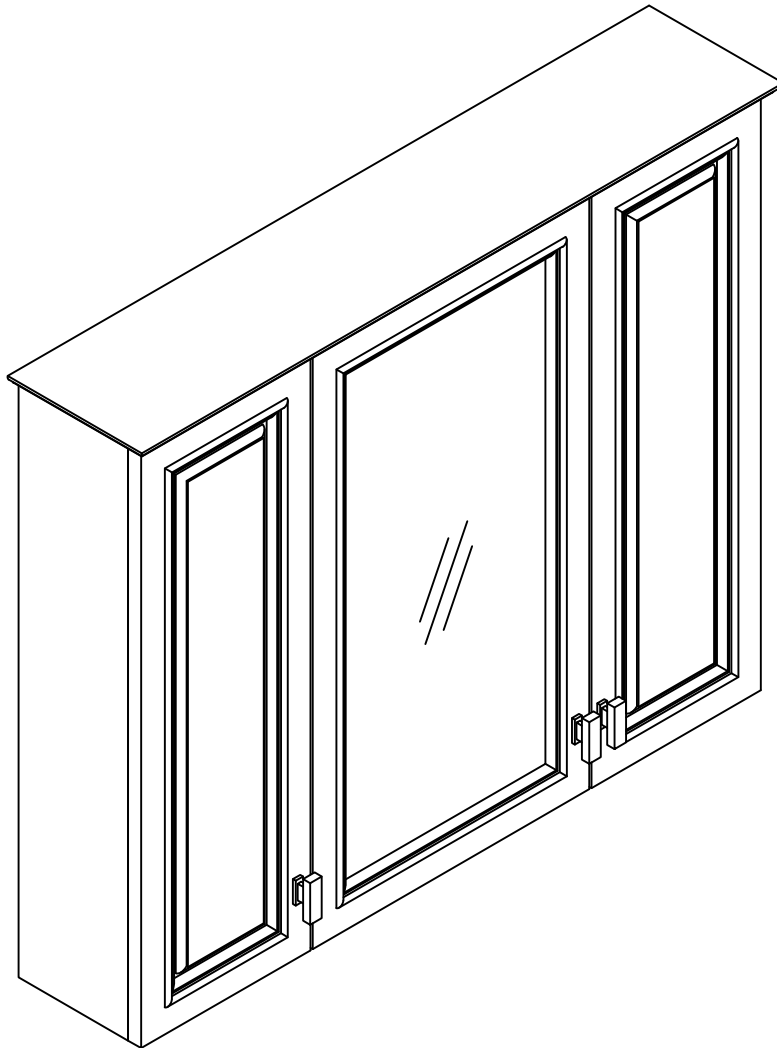

Thank you for purchasing this quality product. Be sure to check all packing material carefully for small parts which may have come loose inside the carton during shipment. Separate, identify and count all parts and hardware.

Compare with the parts list to be sure all parts are present.

"DO NOT TIGHTEN SCREWS UNTIL COMPLETELY ASSEMBLED"

*** Use of power tool to assemble this product will invalidate any claim and damage this product making unsafe!!!**
*** Please assemble on a clean soft surface to avoid damage.**

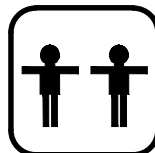
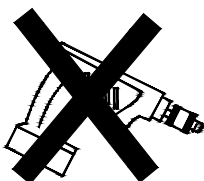

+

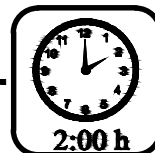

Tools Required

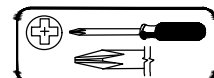

(Not Included)



(Not Included)

IMPORTANT:
PLEASE READ INSTRUCTION BEFORE STARTING THE ASSEMBLY

PLEASE DO NOT RETURN TO STORE

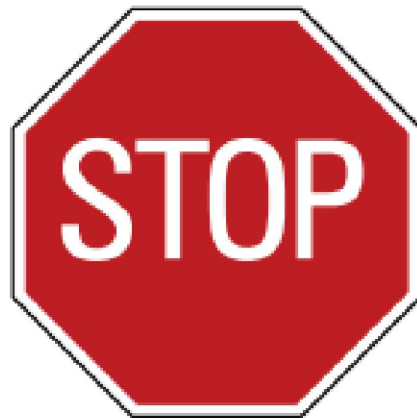

**Please do not return this product to the retailer!!
We are able to assist you in ANY way**

If you find that you have any trouble with assembly or missing or damaged parts please contact the seller.

Before Installation





Important - Please read these instructions fully before starting assembly

Thank you for purchasing this quality product. Be sure to check all packing materials carefully for small parts, which may have come loose inside the carton during shipment. Identify and count all items according to the PARTS LIST and/or HARDWARE LIST shown below. Check you have all the components and tools listed on the following pages.

- . We recommend that you assemble this product with the assistance of another person; this will make the assembly easier, and will help eliminate damage to the product or injury to persons during assembly.
- . Please do not over tighten screws or bolts until the assembly is completed.
- . Keep children and animal away from the work area, small parts could choke if swallowed.
- . Please put all parts on a non-abrasive floor before assembly, and follow the assembly steps to assemble your newly purchased product correctly and efficiently.

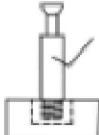
If you find that you have any trouble with assembly or missing or damaged parts please contact the seller.

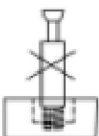
Cam Lock Assembly Instructions

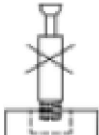
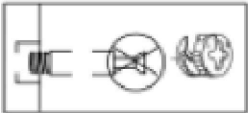
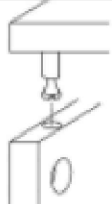
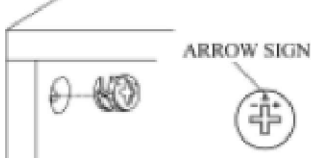
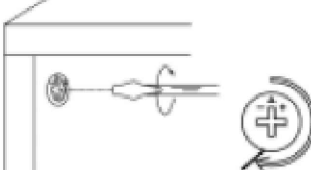
		Insert Cam Bolt into hole as shown in diagram A.
		Make sure not to insert the Cam Bolt: Too deep as shown in figure B as this will cause the Cam Lock to be misaligned and unable to interlock properly.
		Also avoid inserting the Cam Bolt too close to the surface of the hole as shown in figure C, as this will cause the Cam Lock to be too loose, and not interlock properly.
		Connect the panels together.
	ARROW SIGN	Insert the Cam Lock so the side opening fits over the head of the Cam Bolt.
		To tighten the Cam Lock, turn it clockwise on half a turn with a flat screwdriver. <i>*Do not use an automatic screwdriver as it may bend or break if too much power is imposed.</i>

Detail View - CABINET

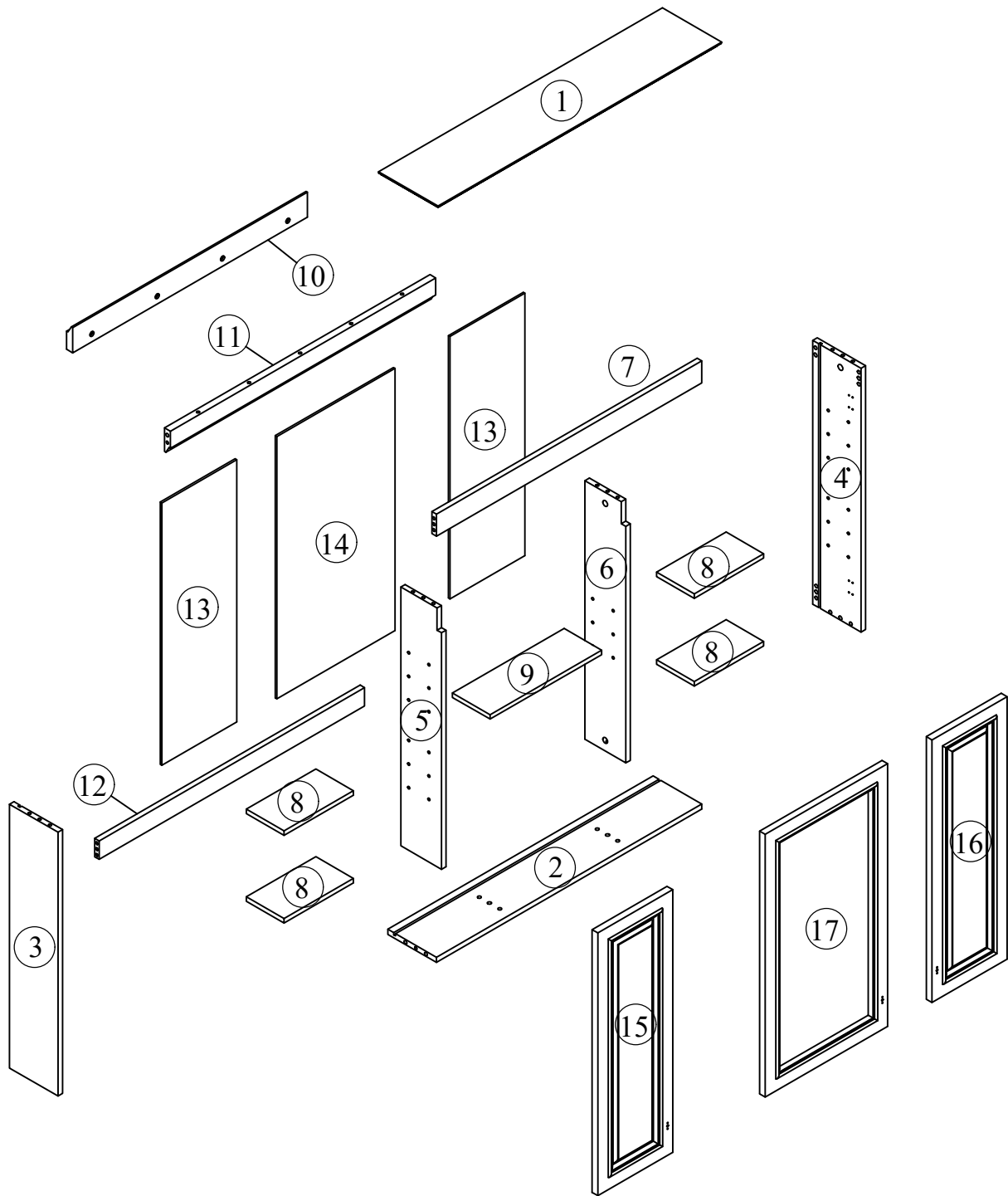

Identifying the Hardware-Identify the hardware using the illustrations below.

Part List - N710P448319

1

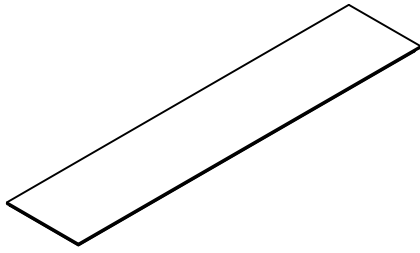

Top Panel - 1pc

2

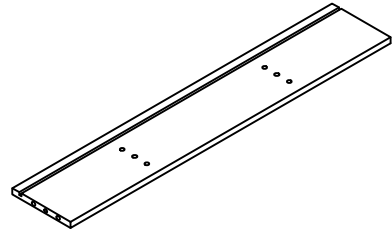

Bottom Panel - 1pc

3

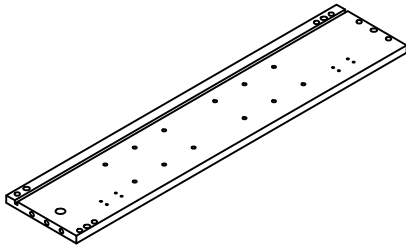

Side Panel (L) - 1pc

4

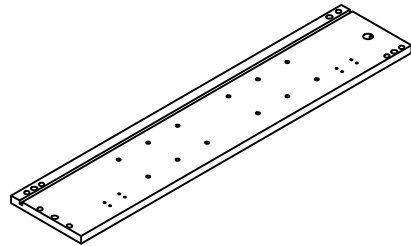

Side Panel (R) - 1pc

5

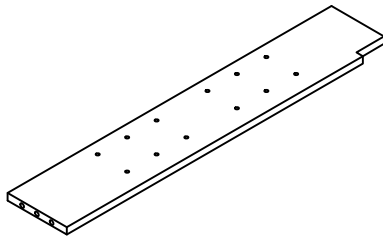

Mid Panel (L) - 1pc

6

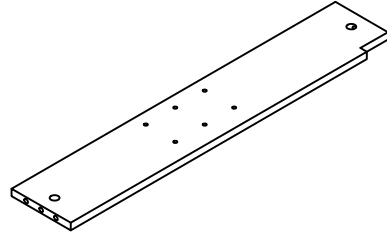

Mid Panel (R) - 1pc

7

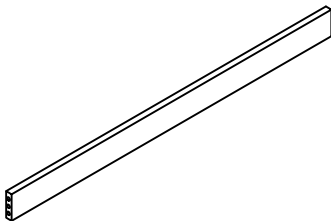

Top Bar Front - 1pc

8

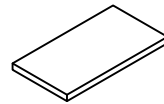

Side Adjustable Shelf - 4pcs

9

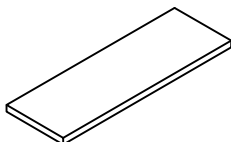

Mid Adjustable Shelf - 1pc

10

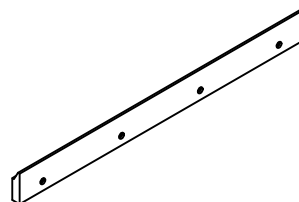

Connect Bar - 1pc

Part List - N710P448319

11

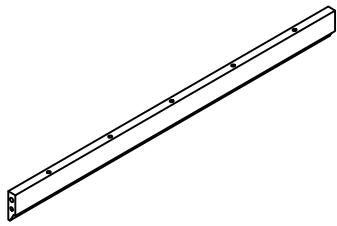

Top Rear Bar - 1pc

12

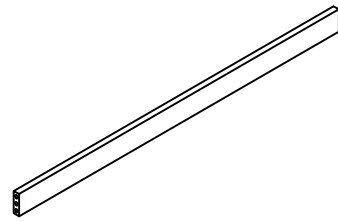

Bottom Bar Rear - 1pc

13

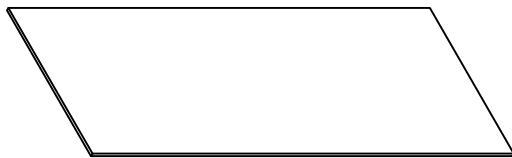

Side Back Panel - 2pcs

14

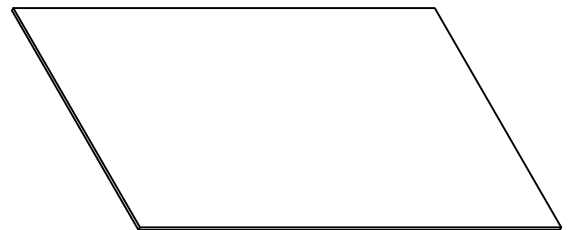

Mid Back Panel - 1pc

15



Left Door - 1pc

16







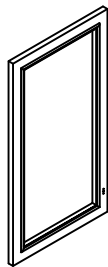

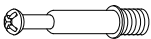

Right Door - 1pc

17

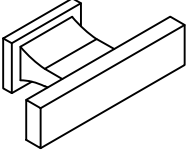
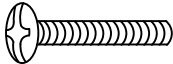
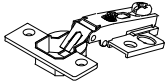
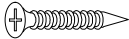

Mid Door - 1pc

Hardware List- N710P448319

<p>A</p>  <p>ø6x35mm</p>	<p>B</p>  <p>ø14.5x12mm</p>	<p>C</p>  <p>ø10xø5x60mm</p>
<p>Three in one bolts (17pcs)</p>	<p>Three in one lock (17pcs)</p>	<p>Flat head screw (4pcs)</p>
<p>D</p>  <p>ø12x55mm</p>	<p>E</p> 	<p>F</p>  <p>ø5/32"x20mm</p>
<p>Plastic stopper (4pcs)</p>	<p>Handle (3pcs)</p>	<p>Handle screw (3pcs)</p>
<p>G</p> 	<p>H</p>  <p>ø7xø3.5x12mm</p>	<p>I</p> 
<p>Damping hinge (6pcs)</p>	<p>Flat head screw (36pcs)</p>	<p>Laminate pad (20pcs)</p>
<p>J</p>  <p>ø8x30mm</p>	<p>K</p>  <p>ø7xø3.5x15mm</p>	
<p>Wood dowel (28pcs)</p>	<p>Round head screw (4pcs)</p>	

STEP: 1

A

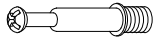

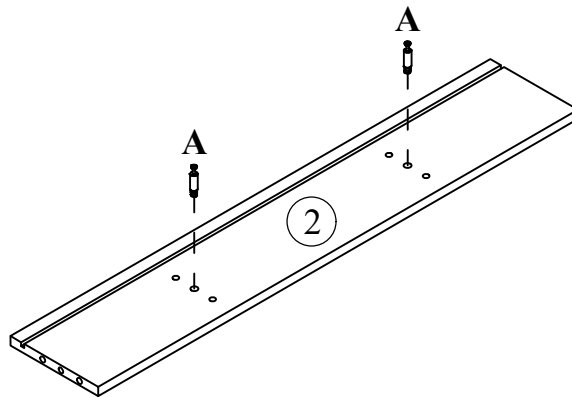
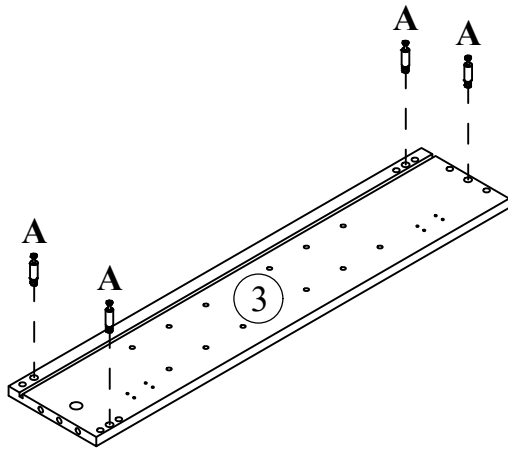
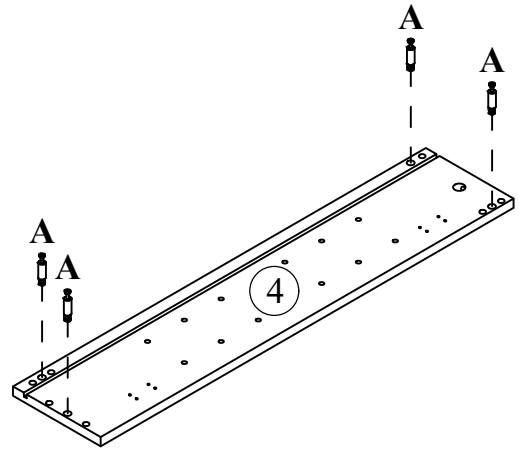
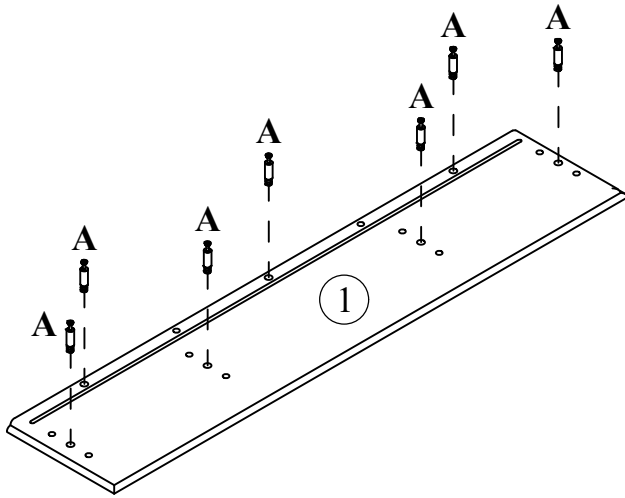

17PCS



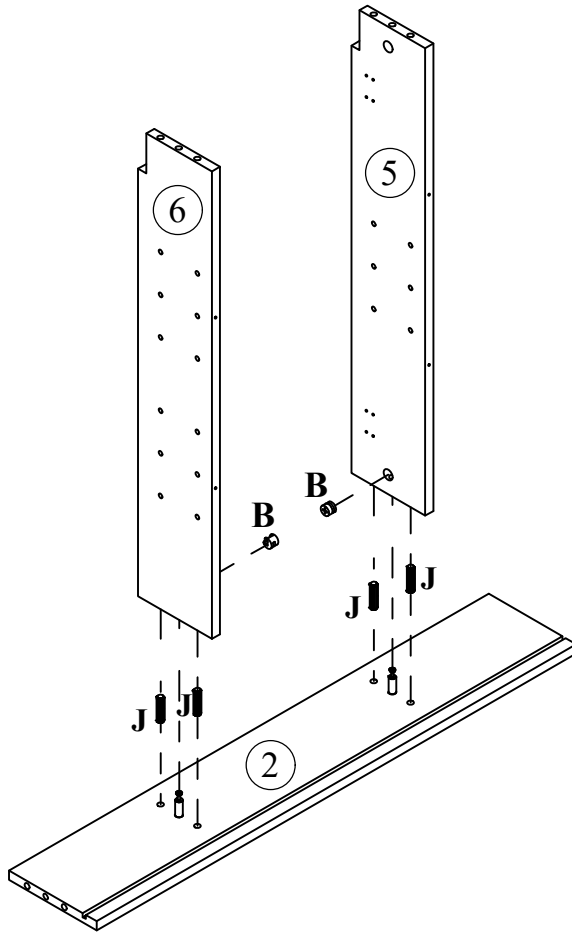

STEP: 2



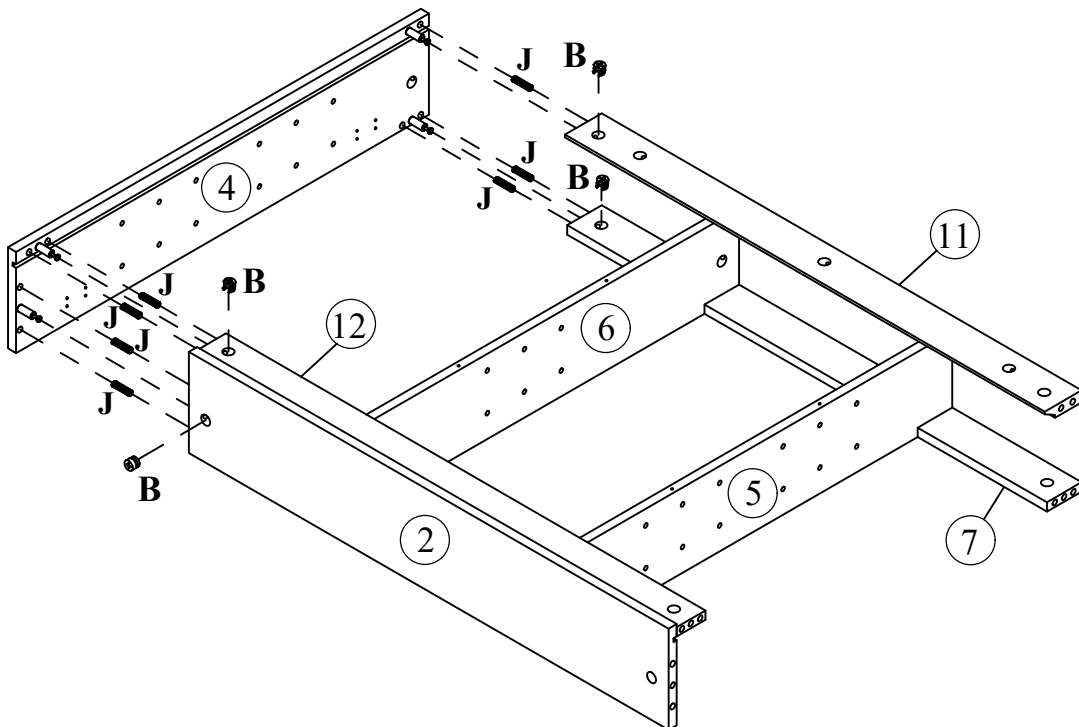

B	J
	
2PCS	4PCS

STEP: 3



B	J
	
4PCS	7PCS

STEP: 4

B		J	
4PCS		7PCS	

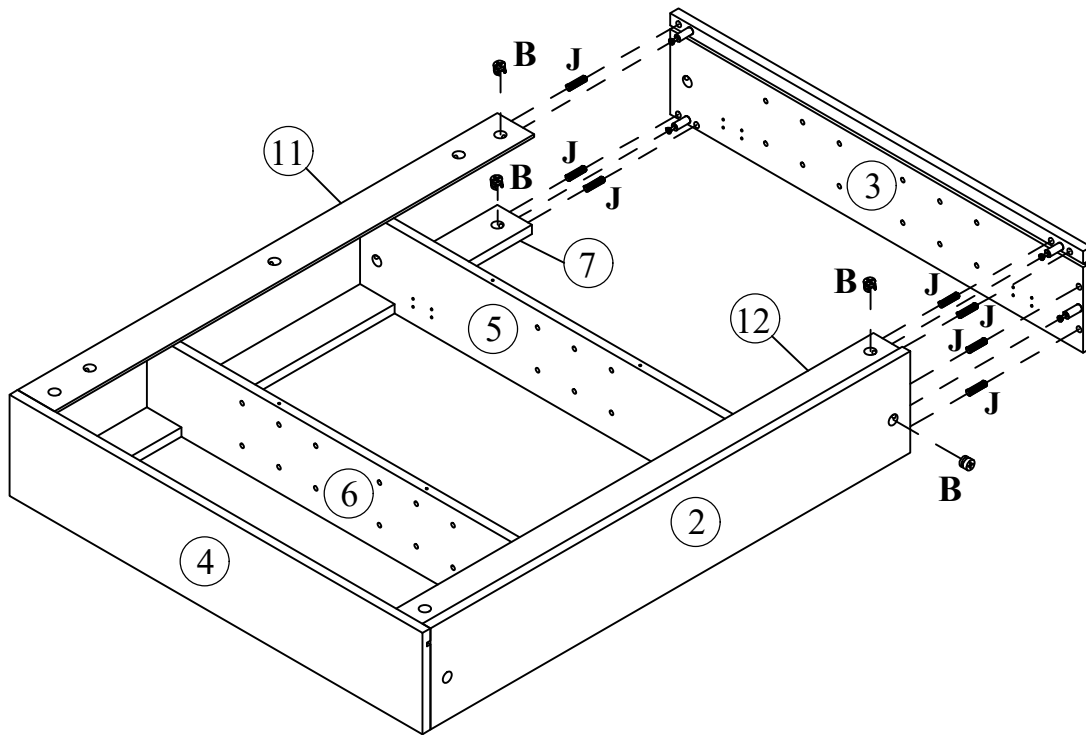

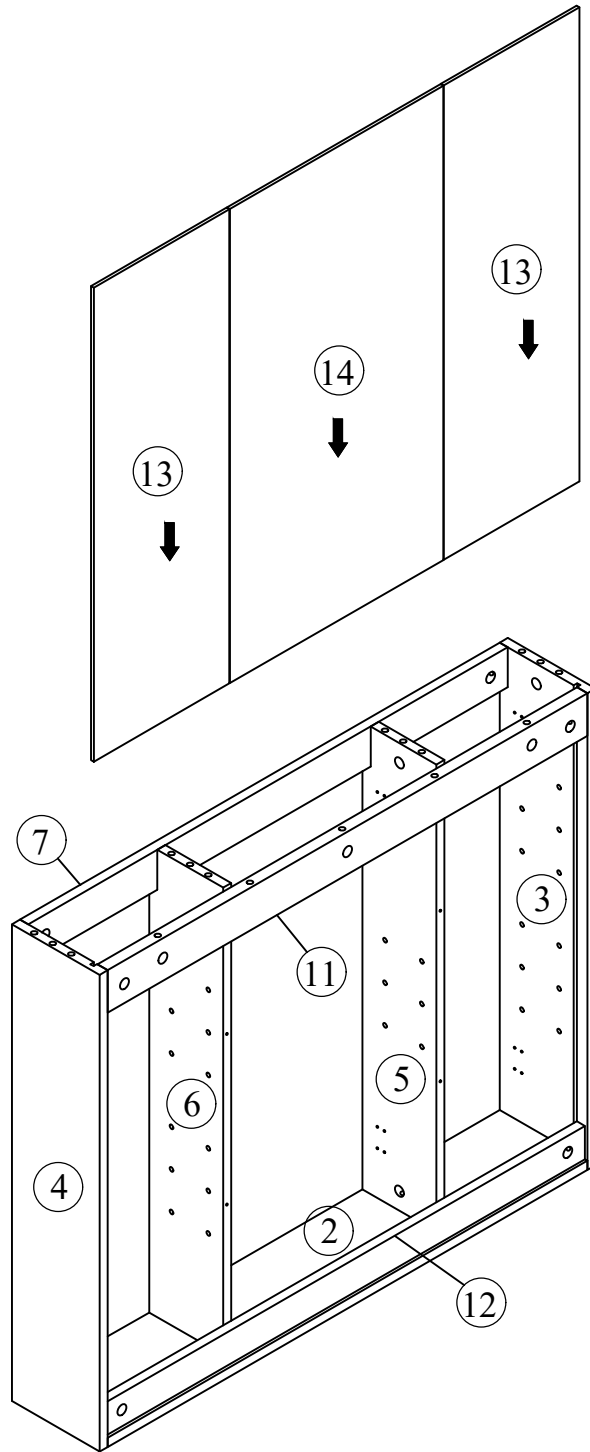

STEP: 5



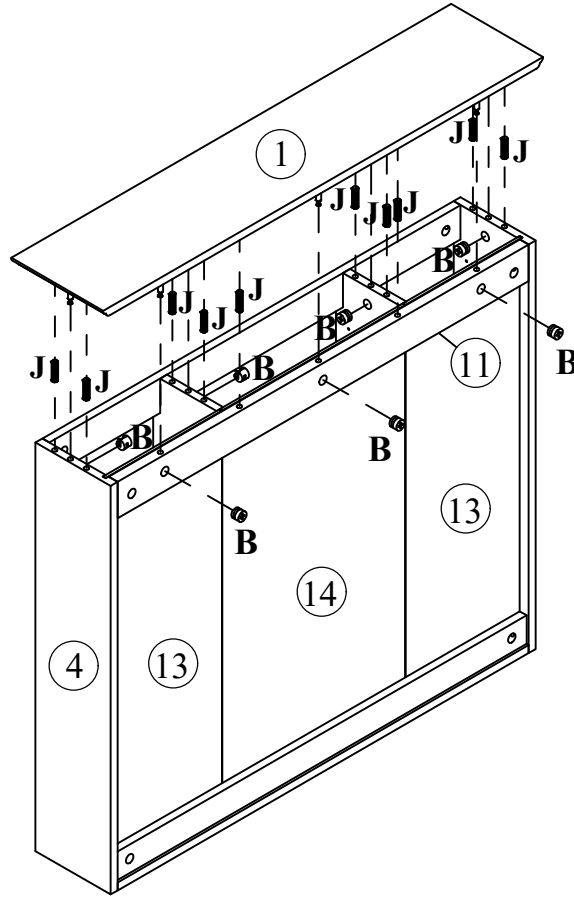

STEP: 6



B		J	
7PCS		10PCS	

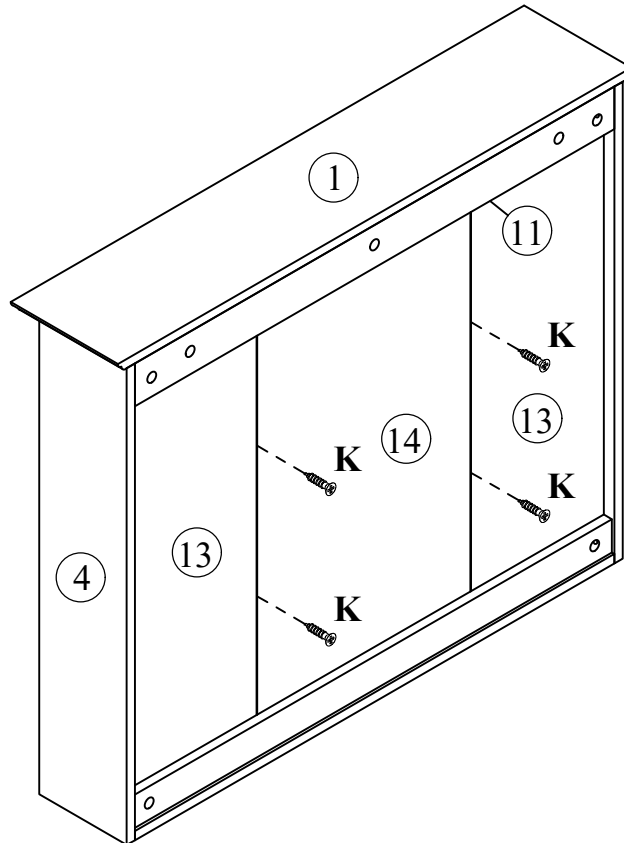

STEP: 7



K	
4PCS	

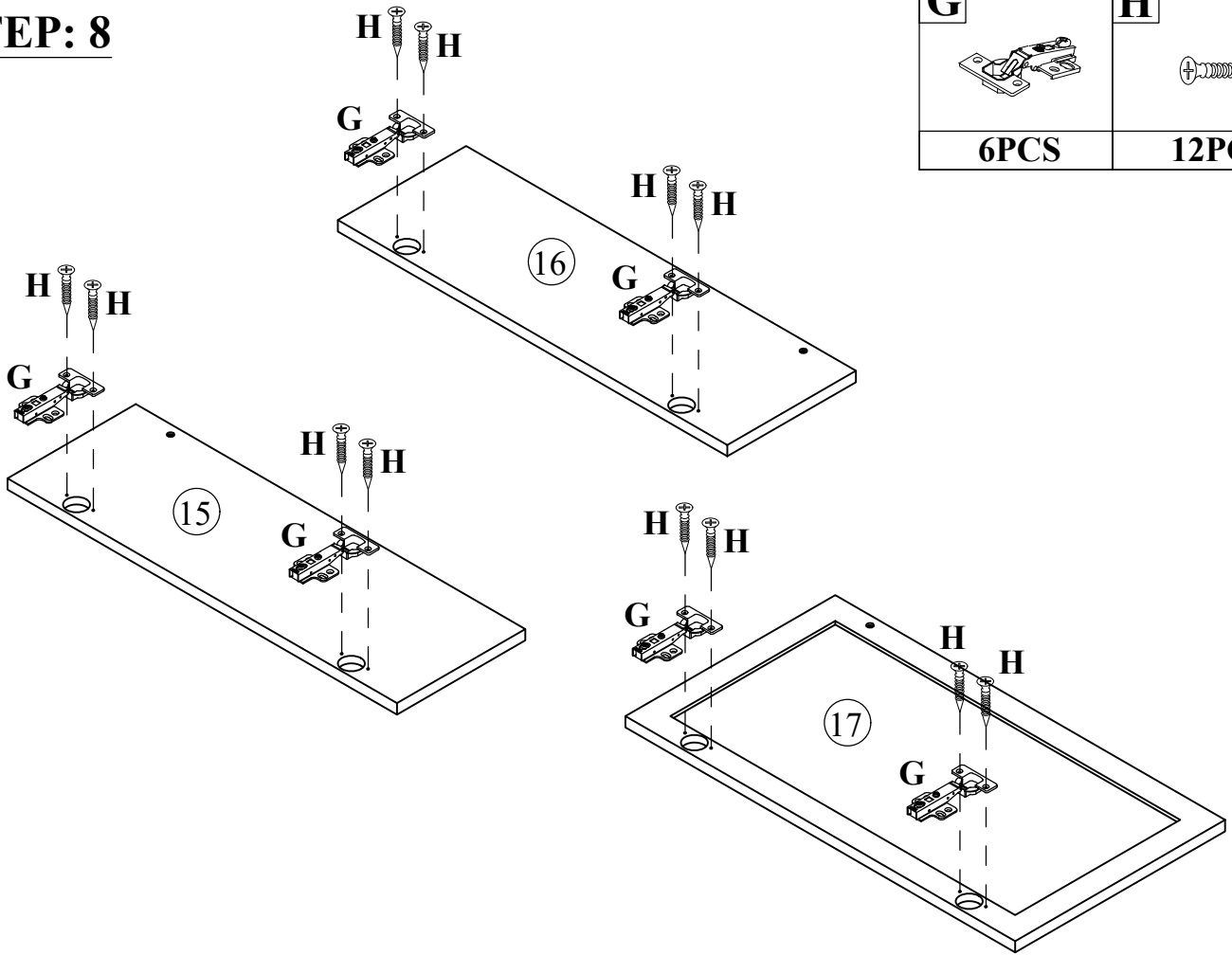

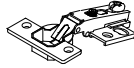
STEP: 8

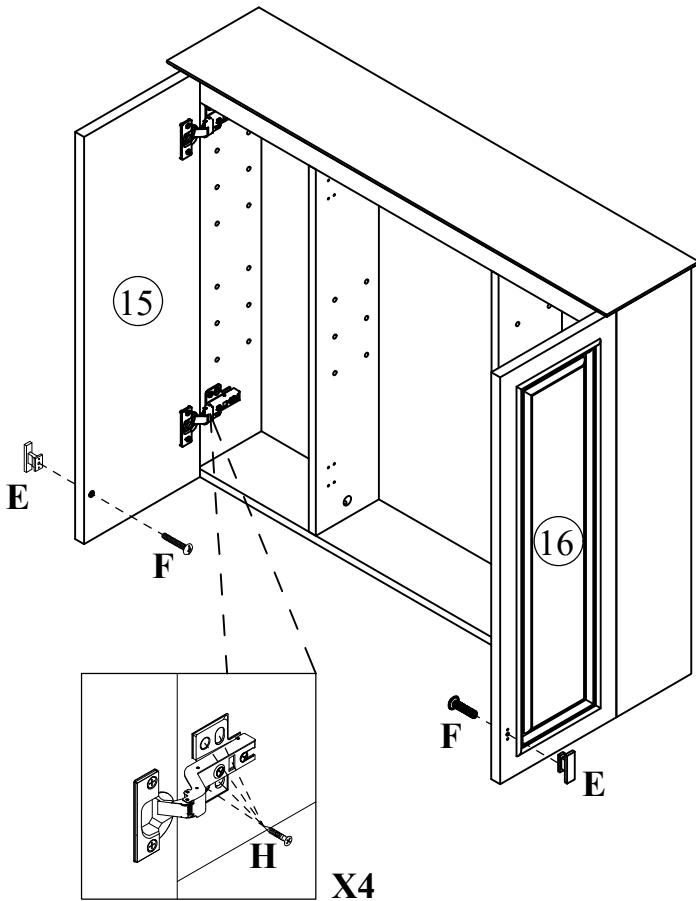

G	H
	
6PCS	12PCS

STEP: 9

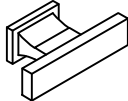
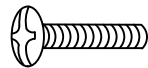

E	F	H
		
2PCS	2PCS	16PCS

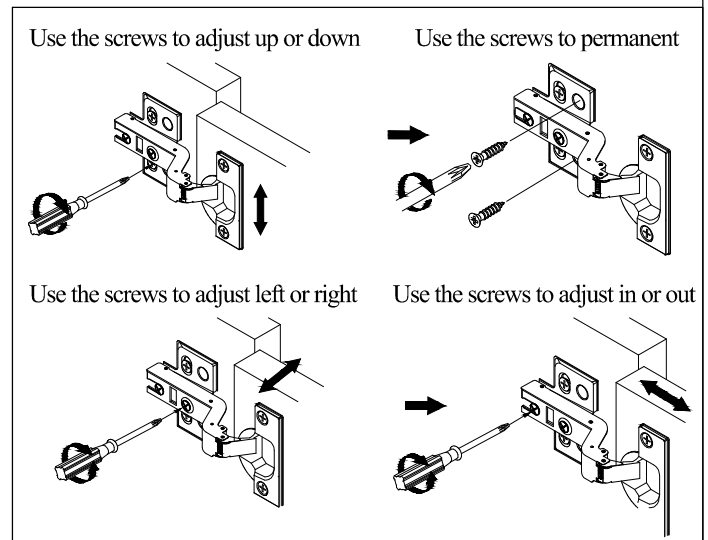

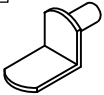

STEP: 10

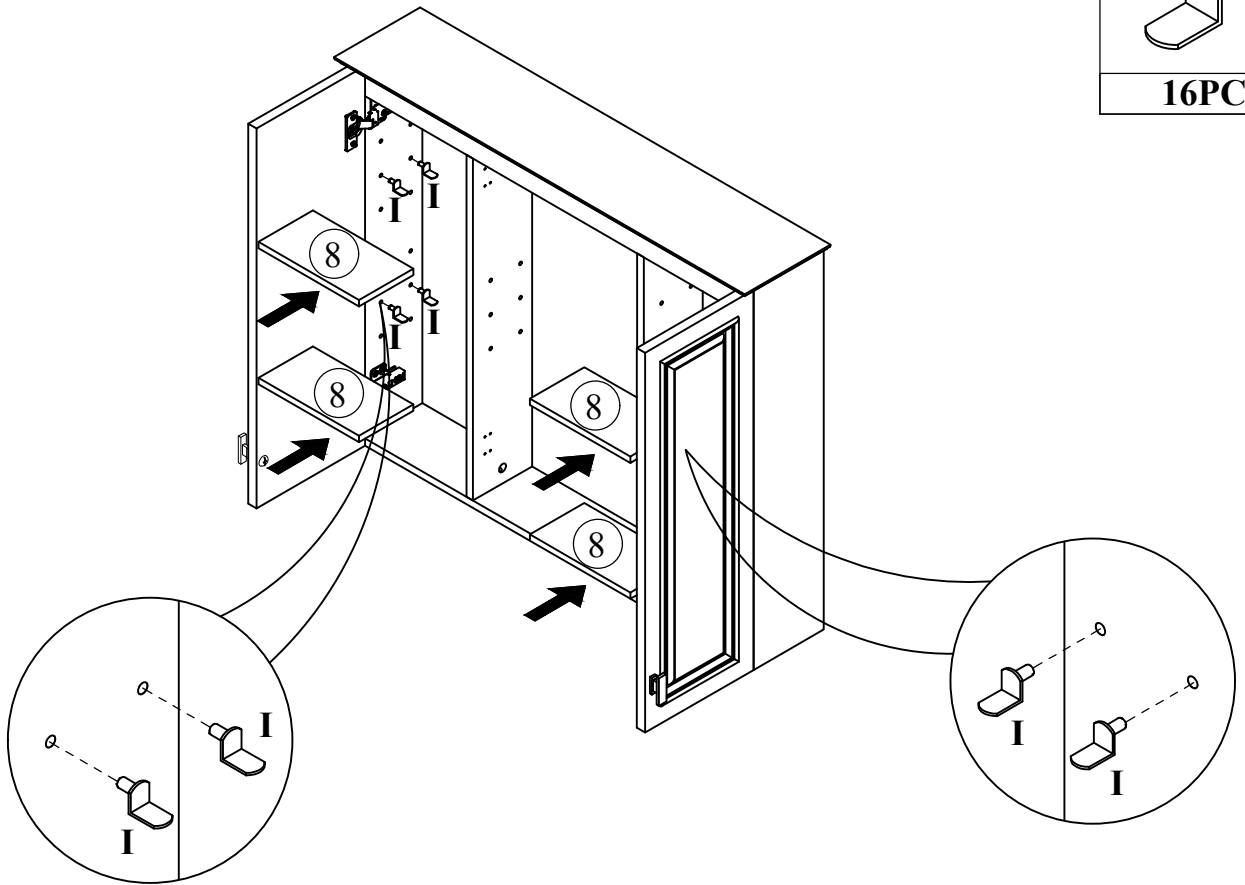
I

16PCS

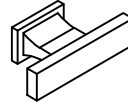
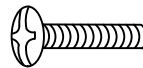

STEP: 11

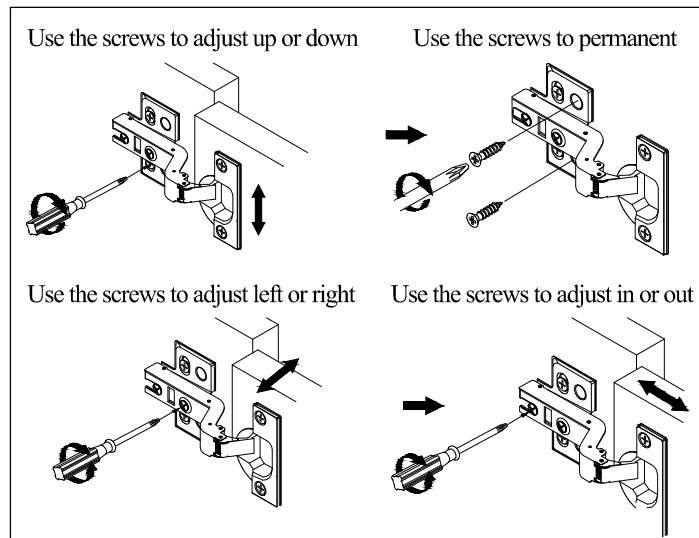
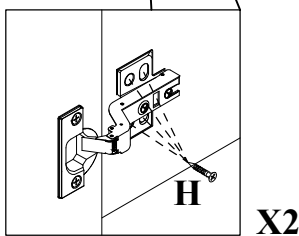
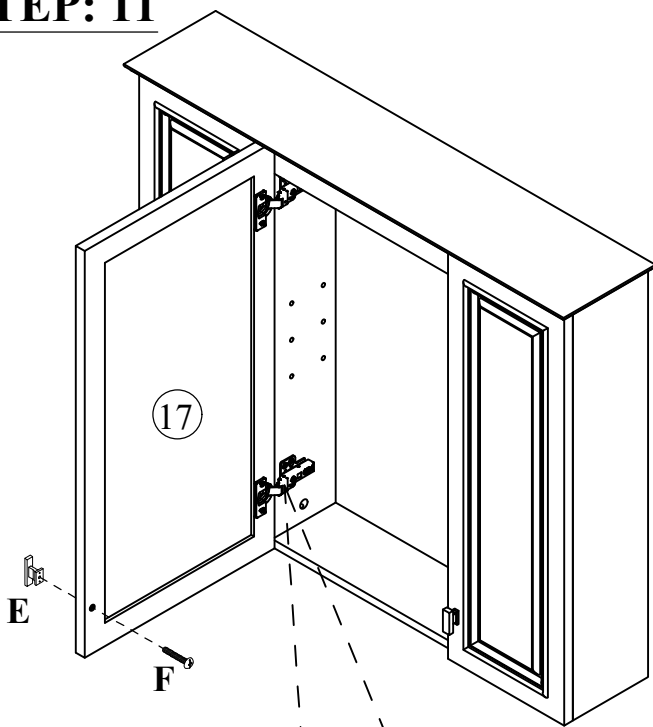
E	F	H
		
1PC	1PC	8PCS



STEP: 12

I

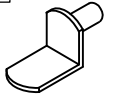

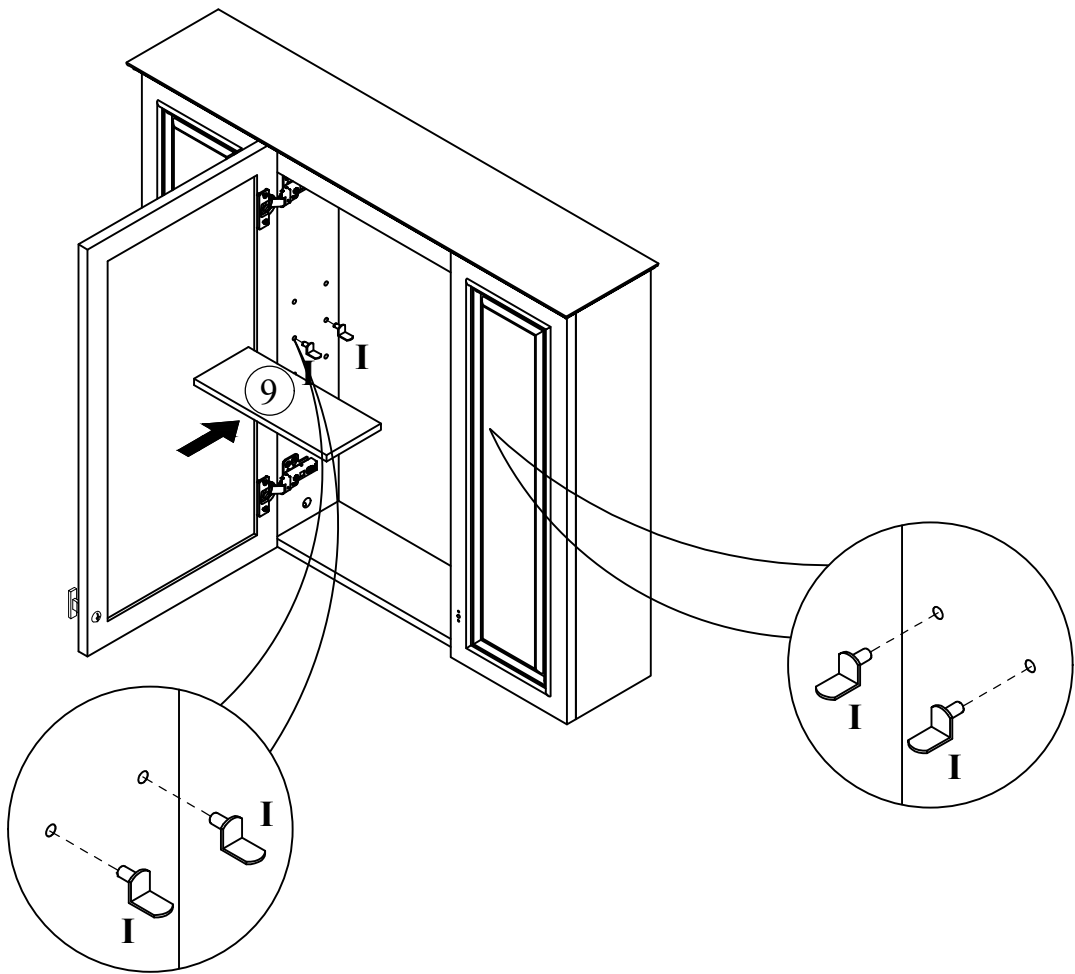

4PCS

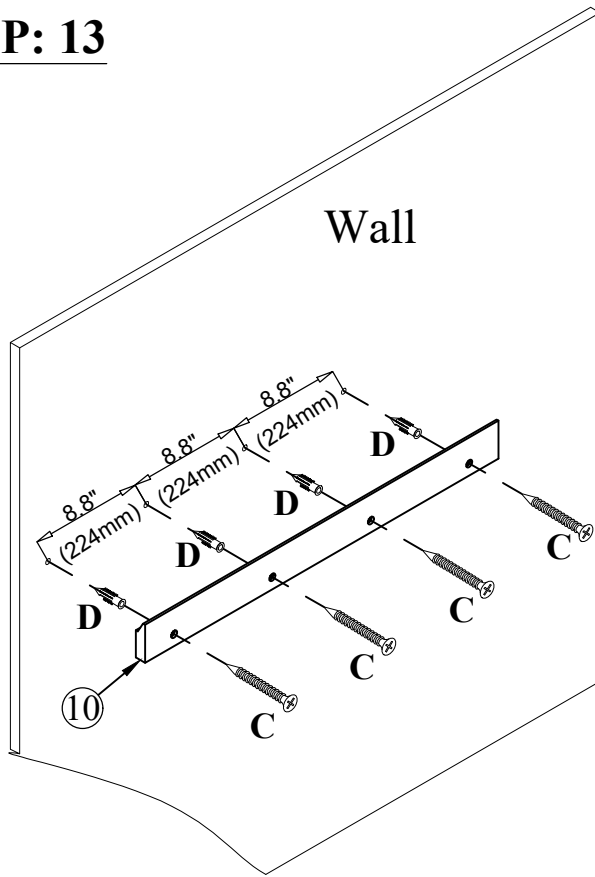

STEP: 13

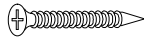

C	D
	
4PCS	4PCS

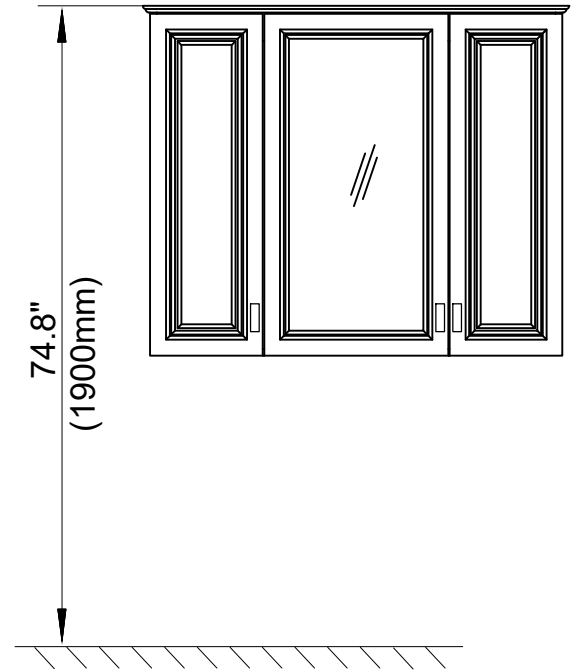

Draw the spacing between the walls and the No.10, punch holes in the wall, and fix the No.10 to the wall with screws.

Note: Appropriate distance from the top of cabinet to the ground is 74.8".

STEP: 14

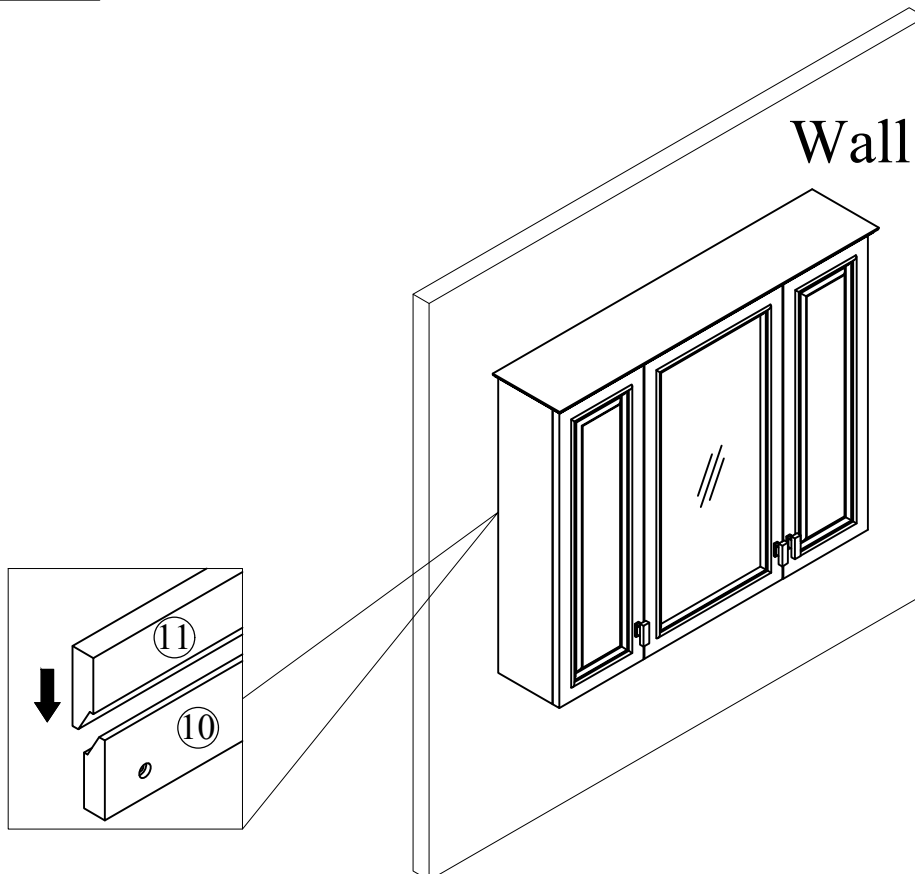

STEP: 15

