

ASSEMBLY INSTRUCTION

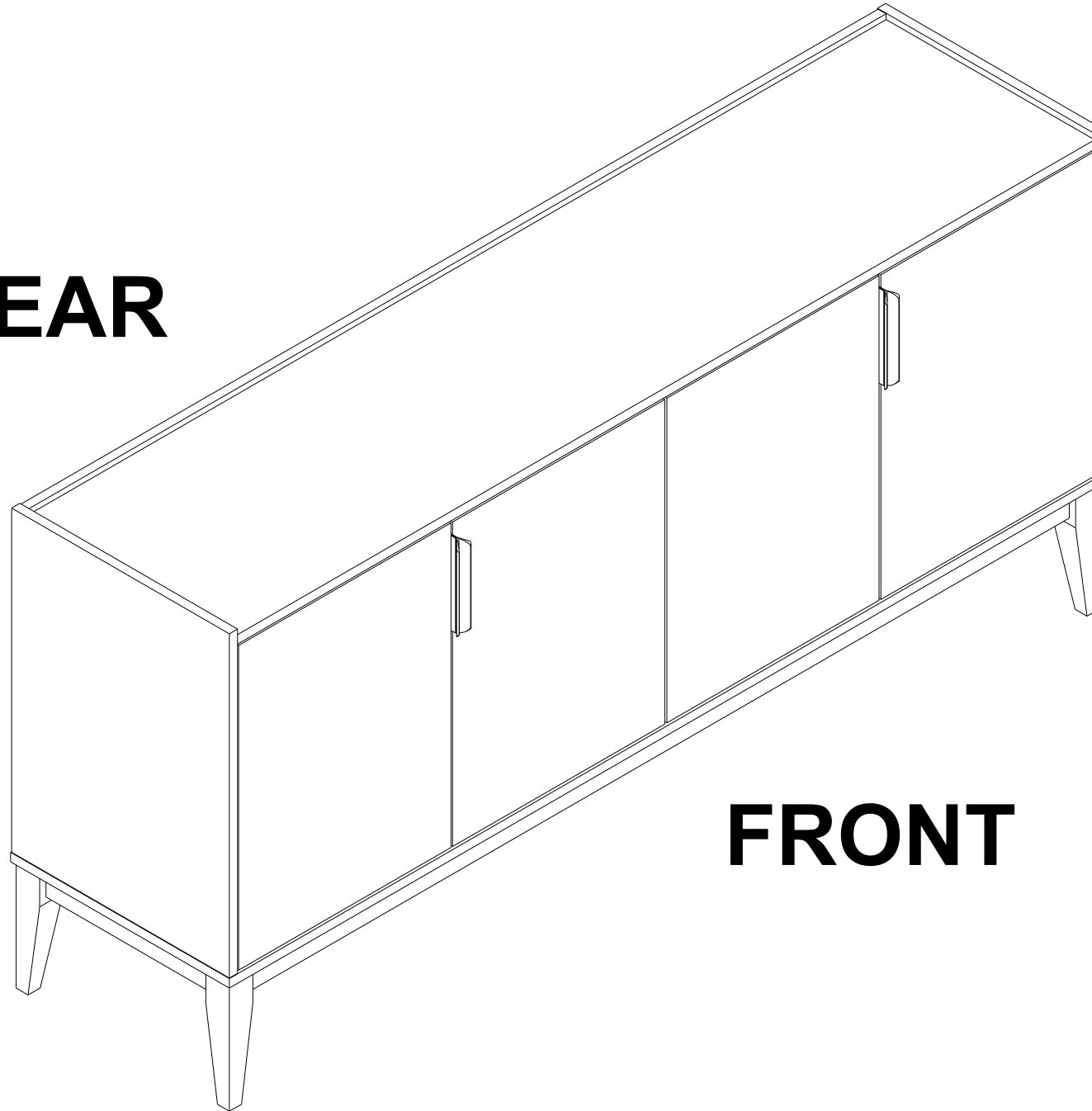

REAR

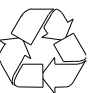

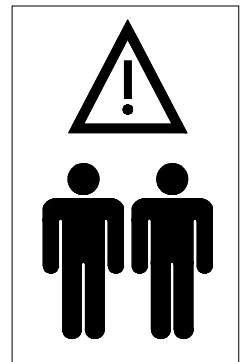



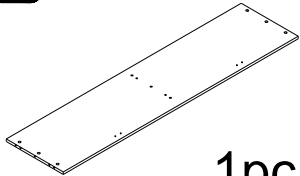
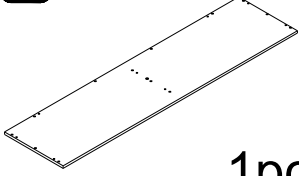
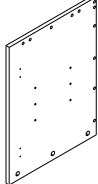
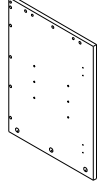
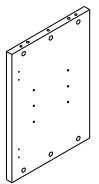
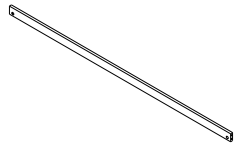
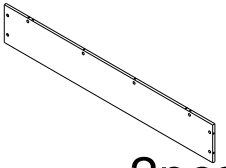
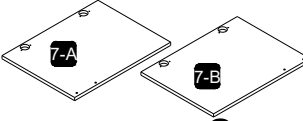
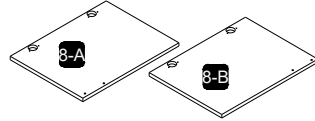
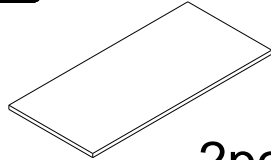
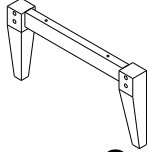
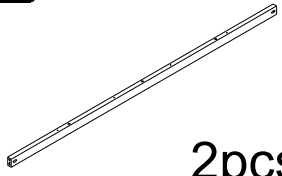

FRONT

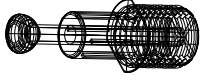

PART LIST

1 Top panel  1pc	2 Bottom panel  1pc	3-L Side Panel(left)  1pc	3-R Side Panel(right)  1pc	4 Division  1pc	5 Back Rail  1pc
6 Back Panel  2pcs	7 Door(Side)  2pcs	8 Door(Center)  2pcs	9 Shelf Panel  2pcs	10 Frame post  2pcs	11 Frame Rail  2pcs
12 Center post  1pc					

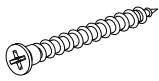
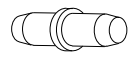
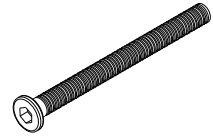
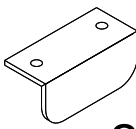
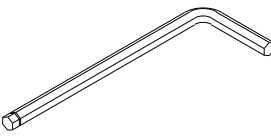
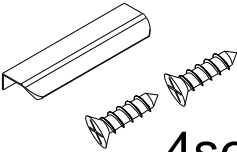
HARDWARE LIST

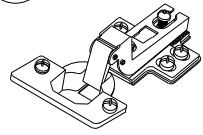
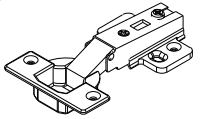
<p>A MINI FIX SPREADING BOLT 24MM</p>  <p>36pcs</p>	<p>B MINIFIX HOUSING Ø15*12MM</p>  <p>6pcs</p>	<p>C MINIFIX HOUSING Ø15*10MM</p>  <p>30pcs</p>	<p>D WOOD DOWEL M8*30MM</p>  <p>32pcs</p>	<p>E CSK SCREW M3.5*12MM</p>  <p>52pcs</p>	<p>F CSK SCREW M4*30MM</p>  <p>16pcs</p>
<p>G SHELF SUPPORT</p>  <p>8pcs</p>	<p>H JCBC M6*40MM</p>  <p>1pc</p>	<p>I DOOR STOPPER</p>  <p>2pcs</p>	<p>J M4 ALLEN KEY</p>  <p>1pc</p>	<p>K HANDLE</p>  <p>4sets</p>	<p>L ADJUSTER</p>  <p>5pcs</p>
<p>M HINGES</p>  <p>4pcs</p>	<p>N HINGES</p>  <p>4pcs</p>				

STEP 1

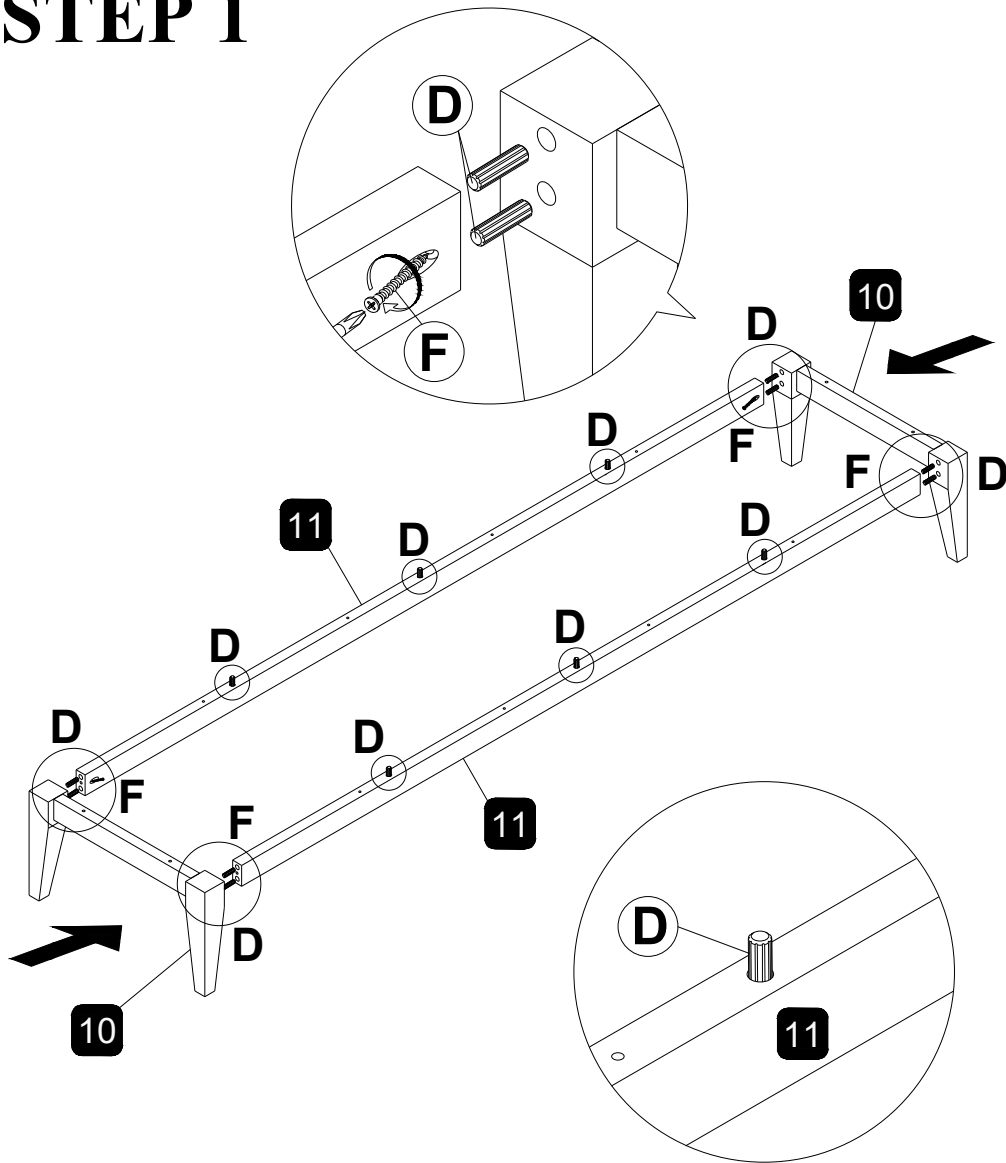

STEP 2

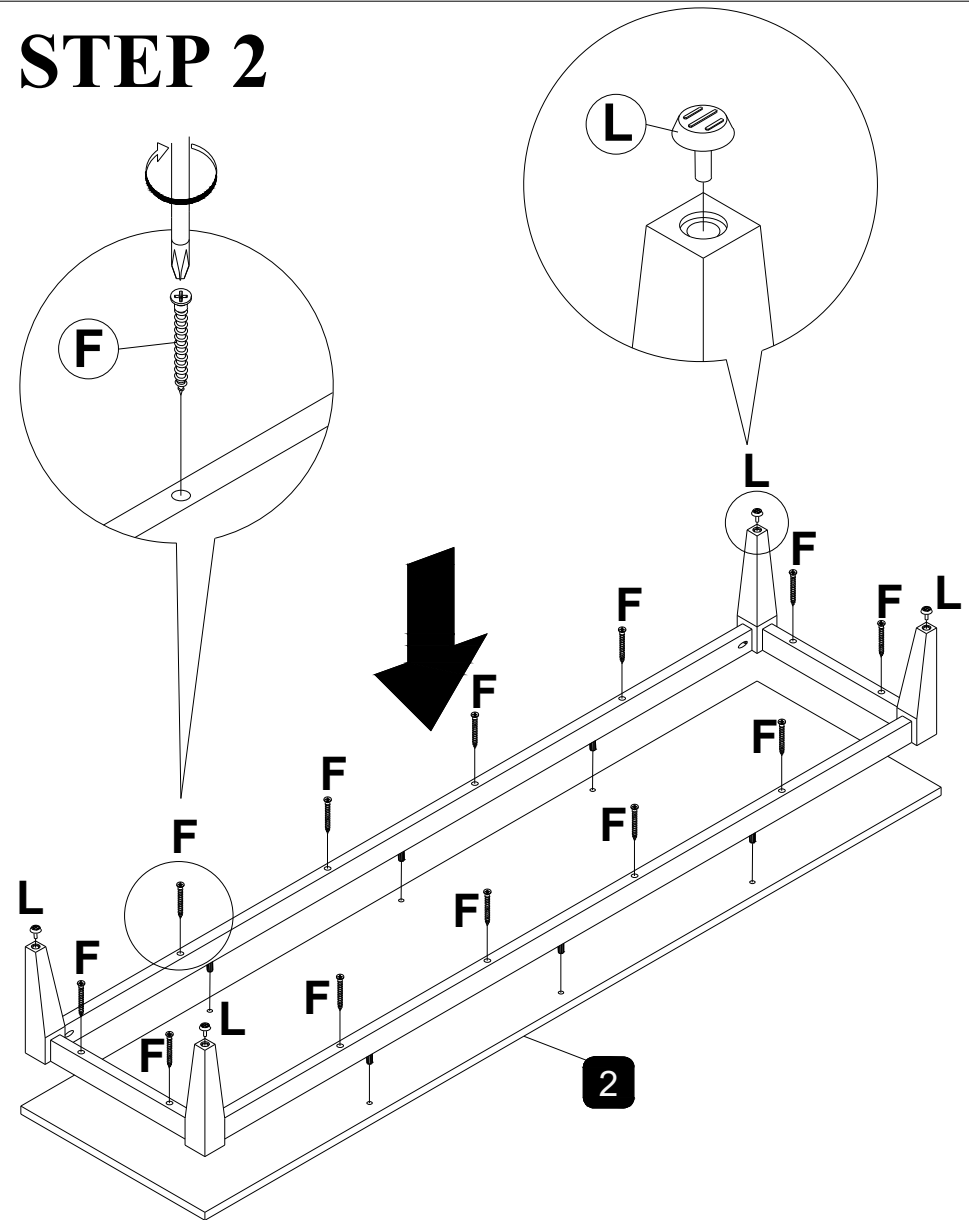

D X 14pcs



F X 4pcs

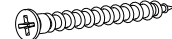

F X 12pcs



L X 4pcs



STEP 3

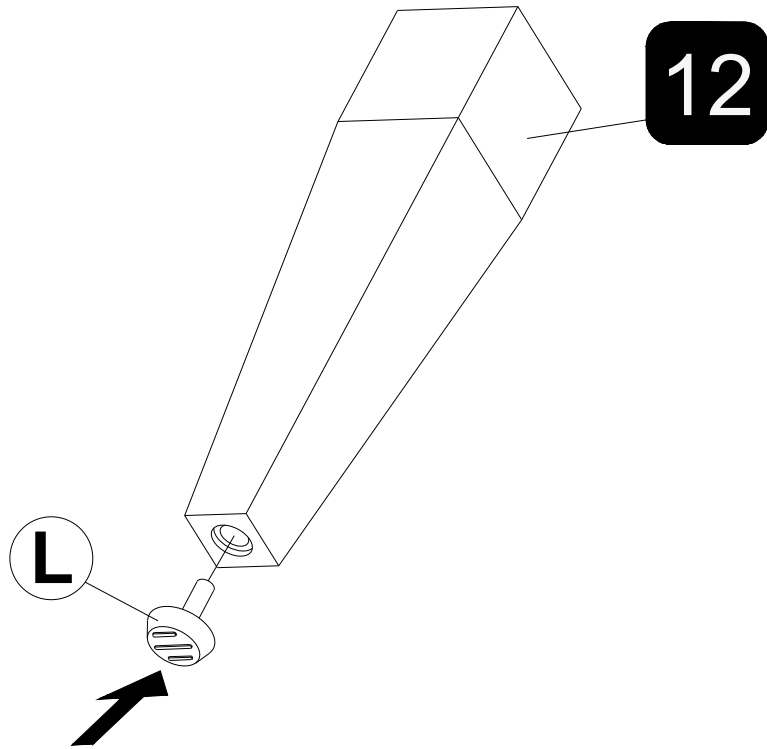

STEP 4

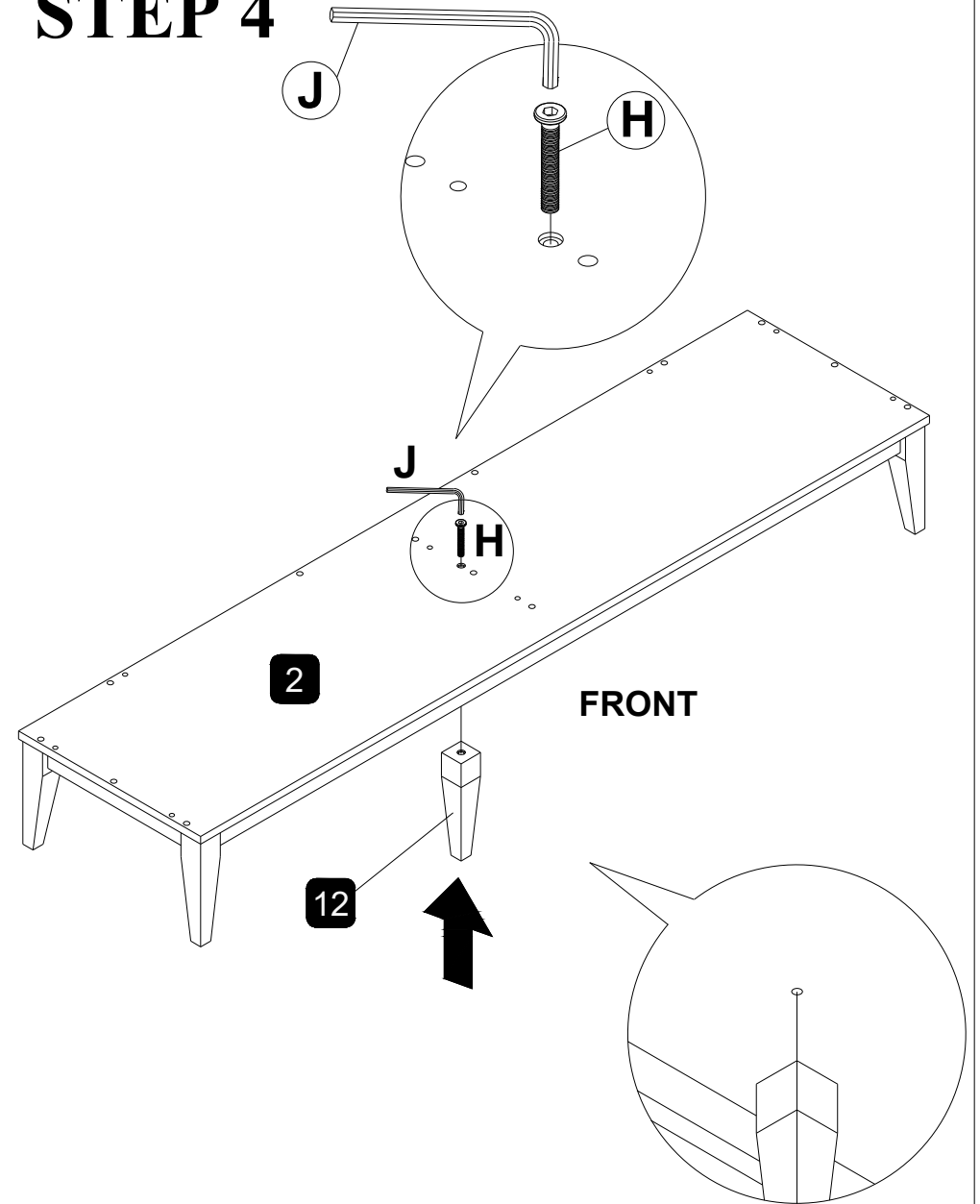



L X 1pc



H X 1pc

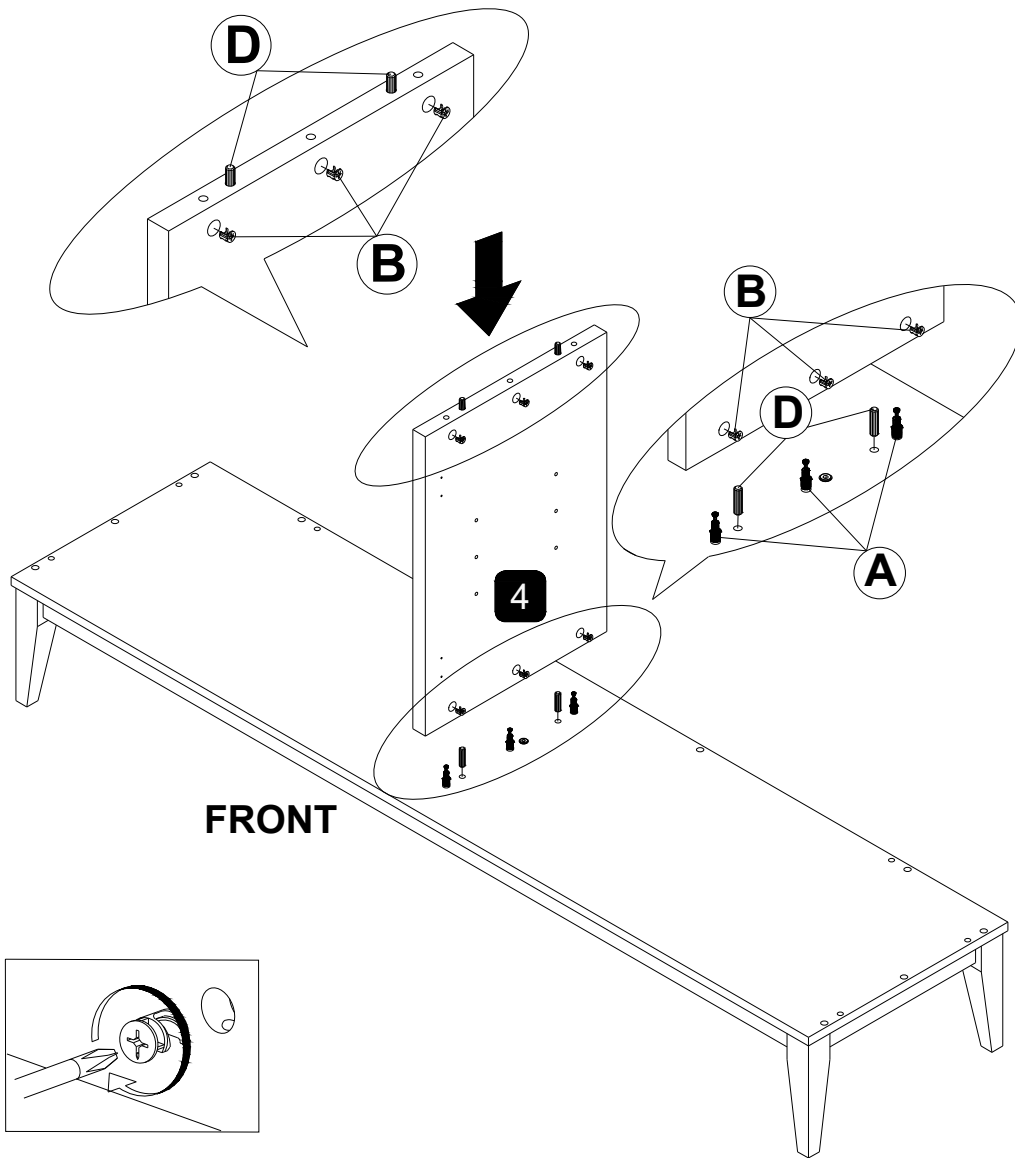

J X 1pc

STEP 5

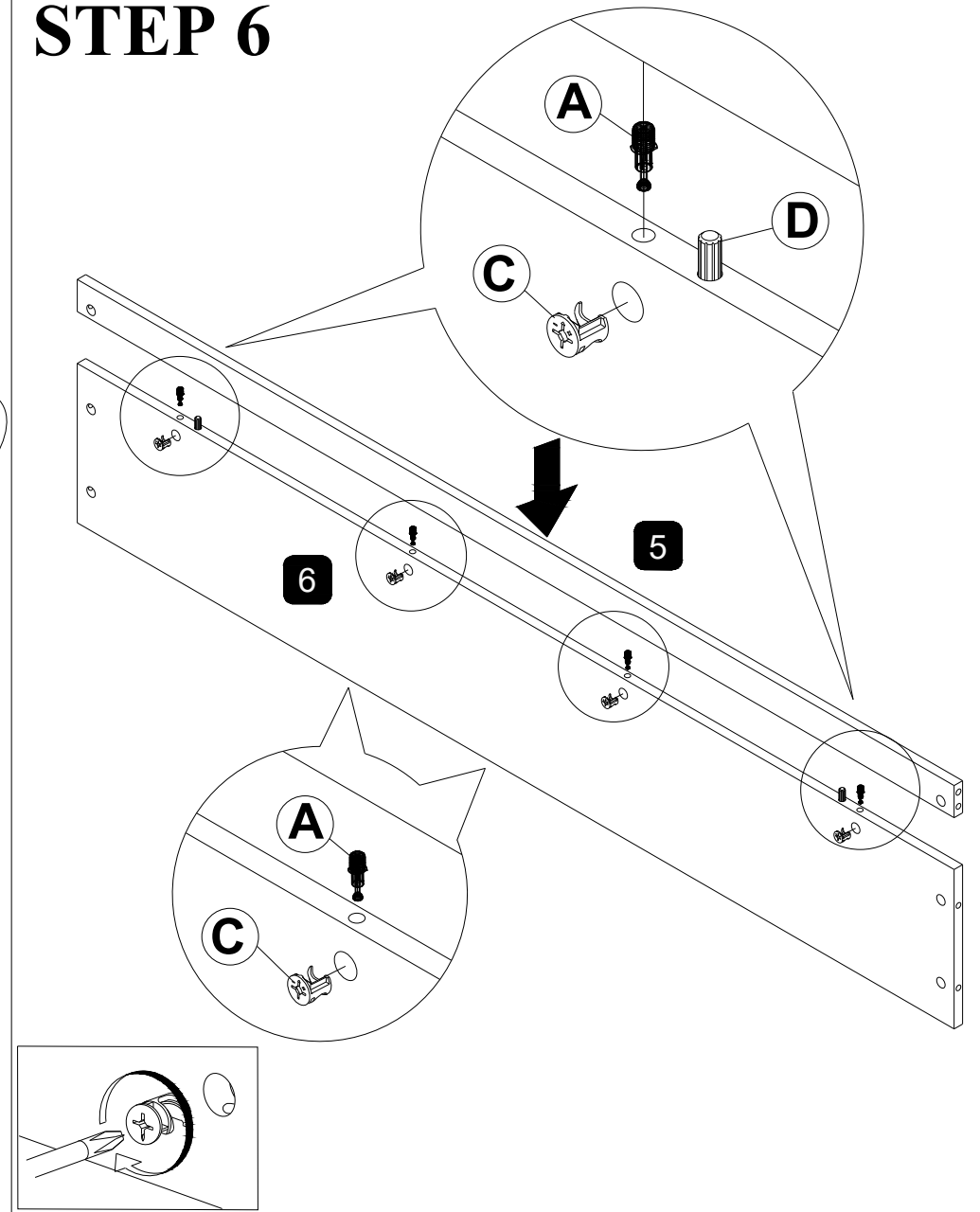

STEP 6





 A X 3pcs

 B X 6pcs

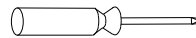
 D X 4pcs

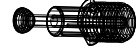

 A X 4pcs

 C X 4pcs

 D X 2pcs

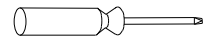

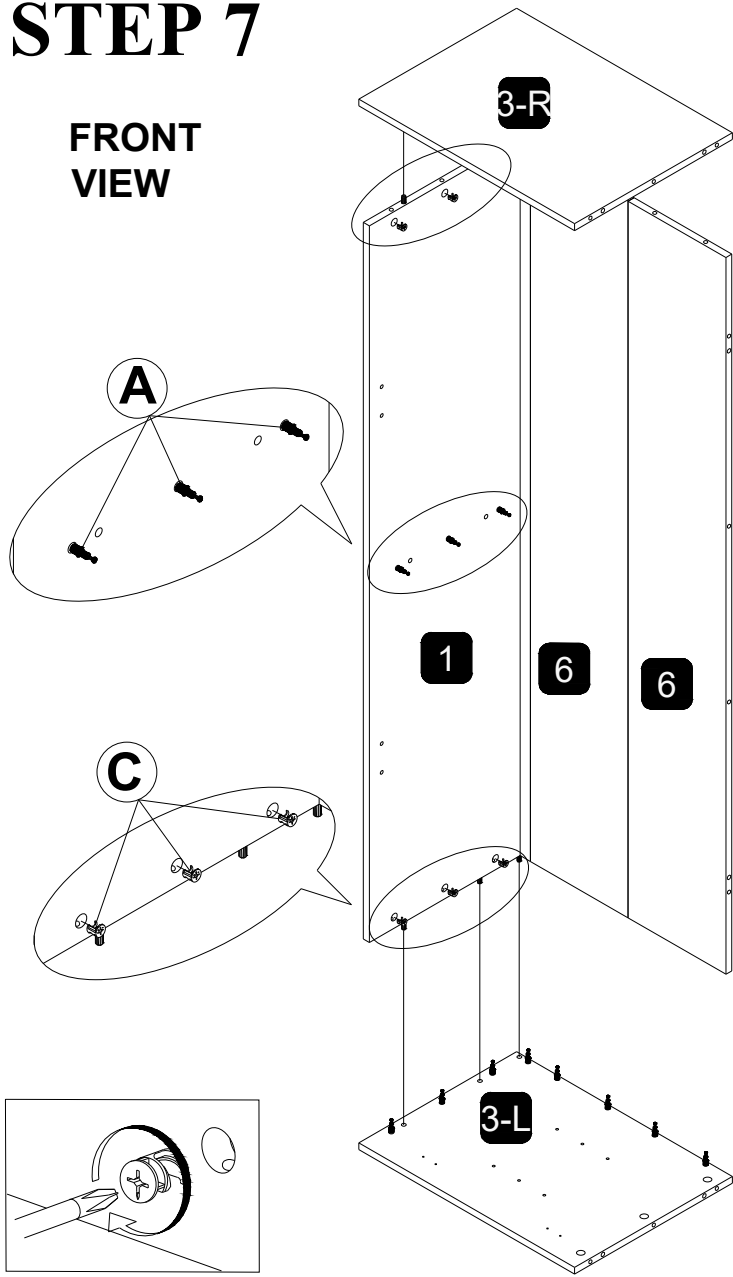

STEP 7

FRONT VIEW

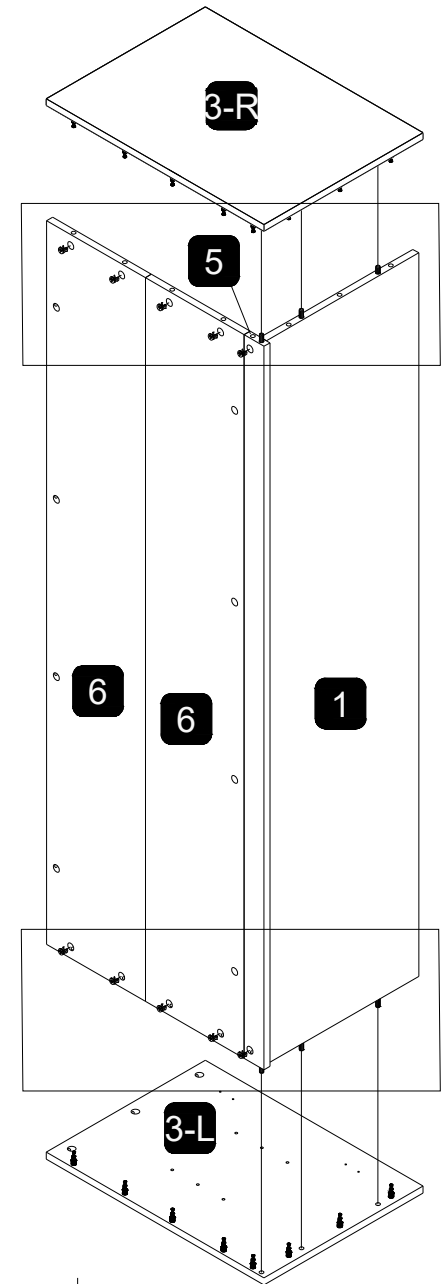
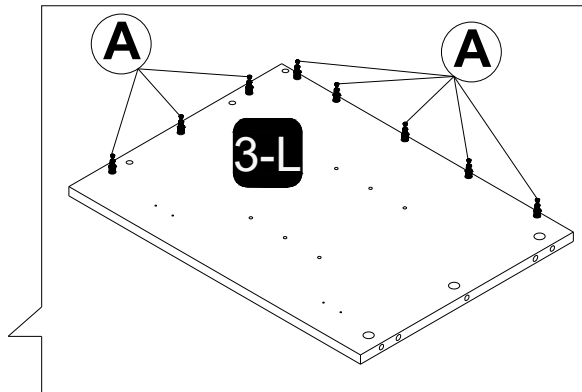
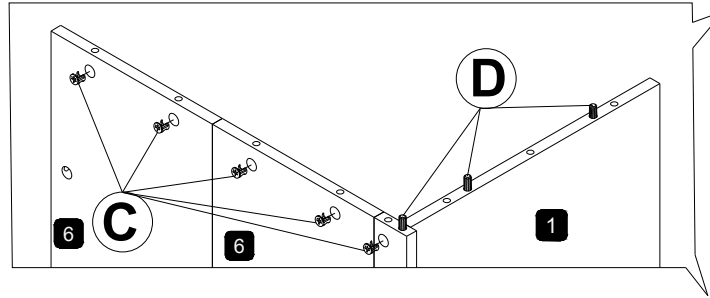

REAR VIEW



 A X 19pcs

 C X 16pcs

 D X 6pcs

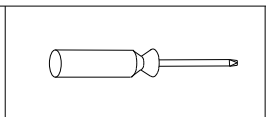

STEP 8

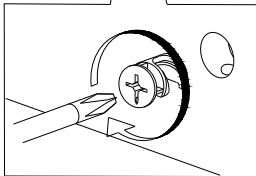
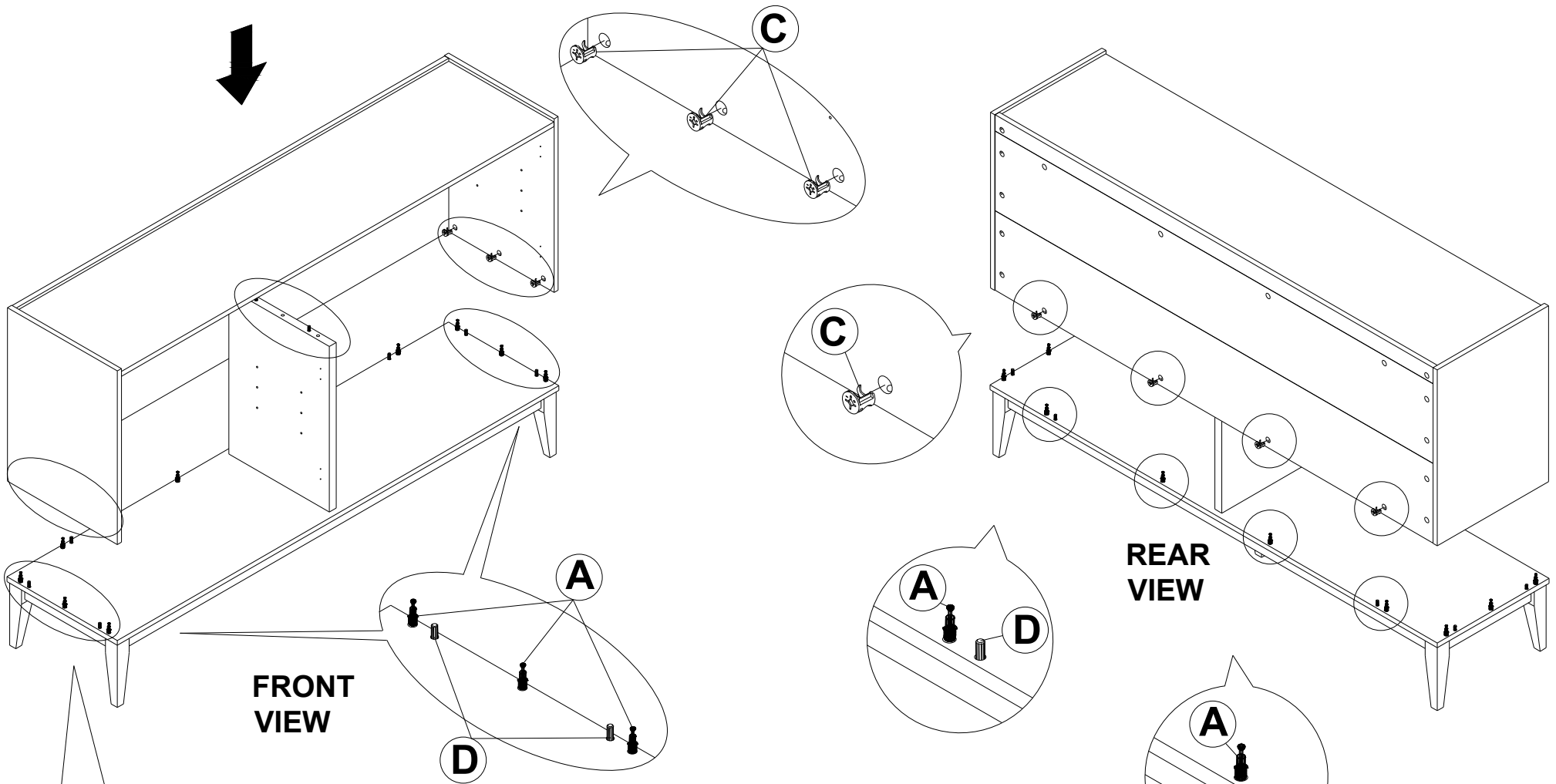

 A X 10pcs

 C X 10pcs

 D X 6pcs

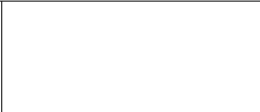
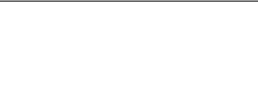
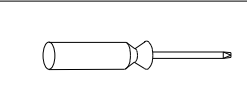

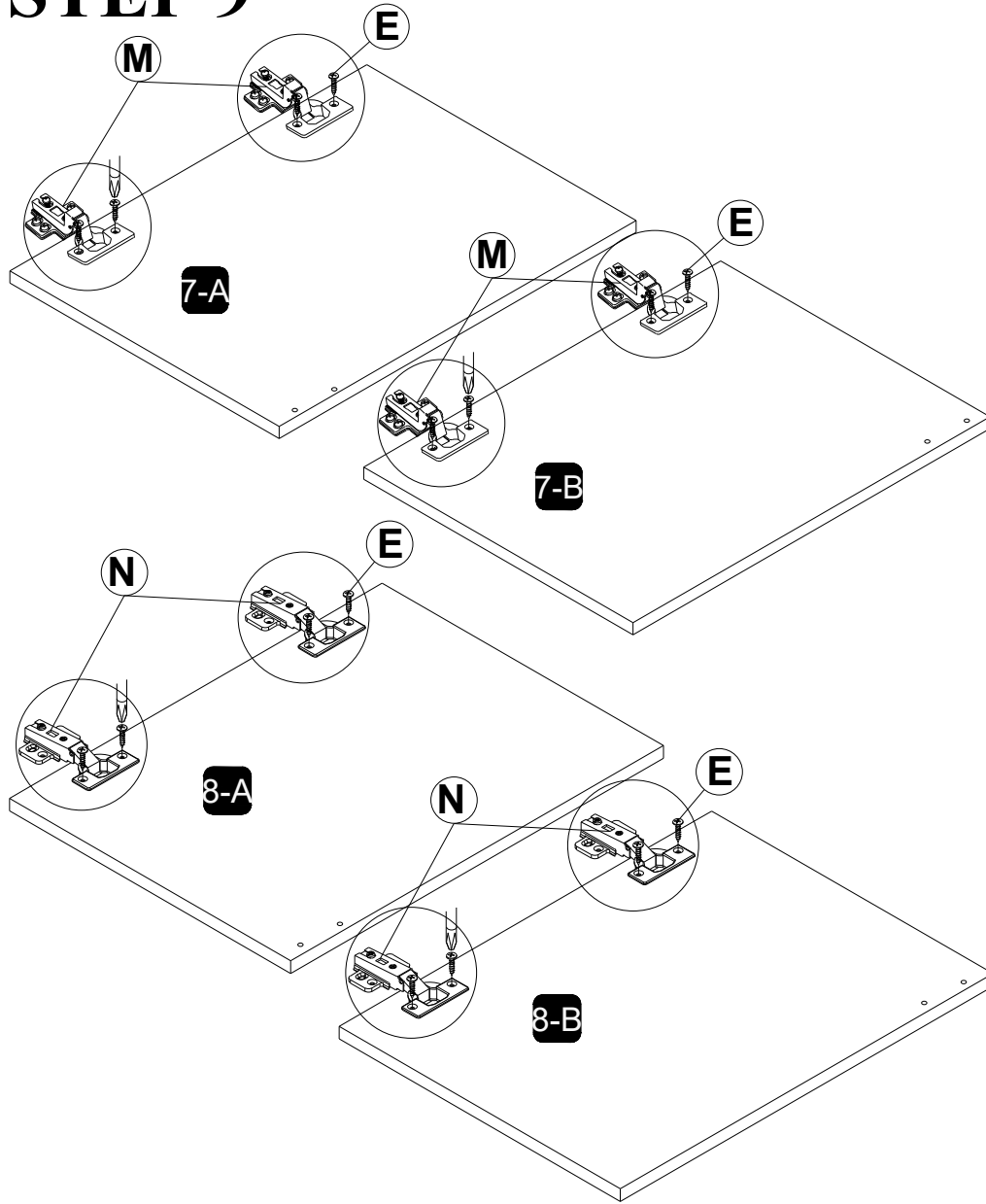

STEP 9

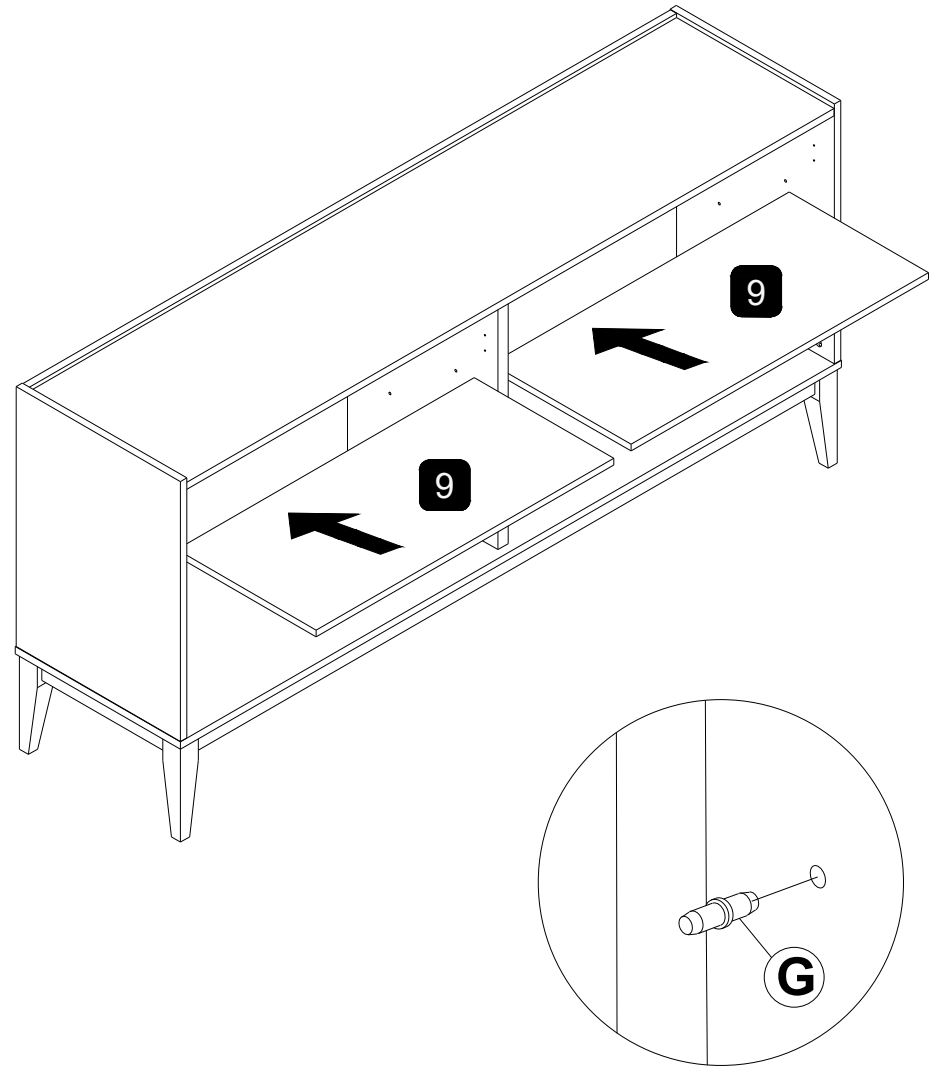

STEP 10





E X 16pcs

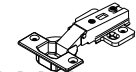

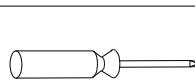
M X 4pcs

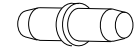
N X 4pcs



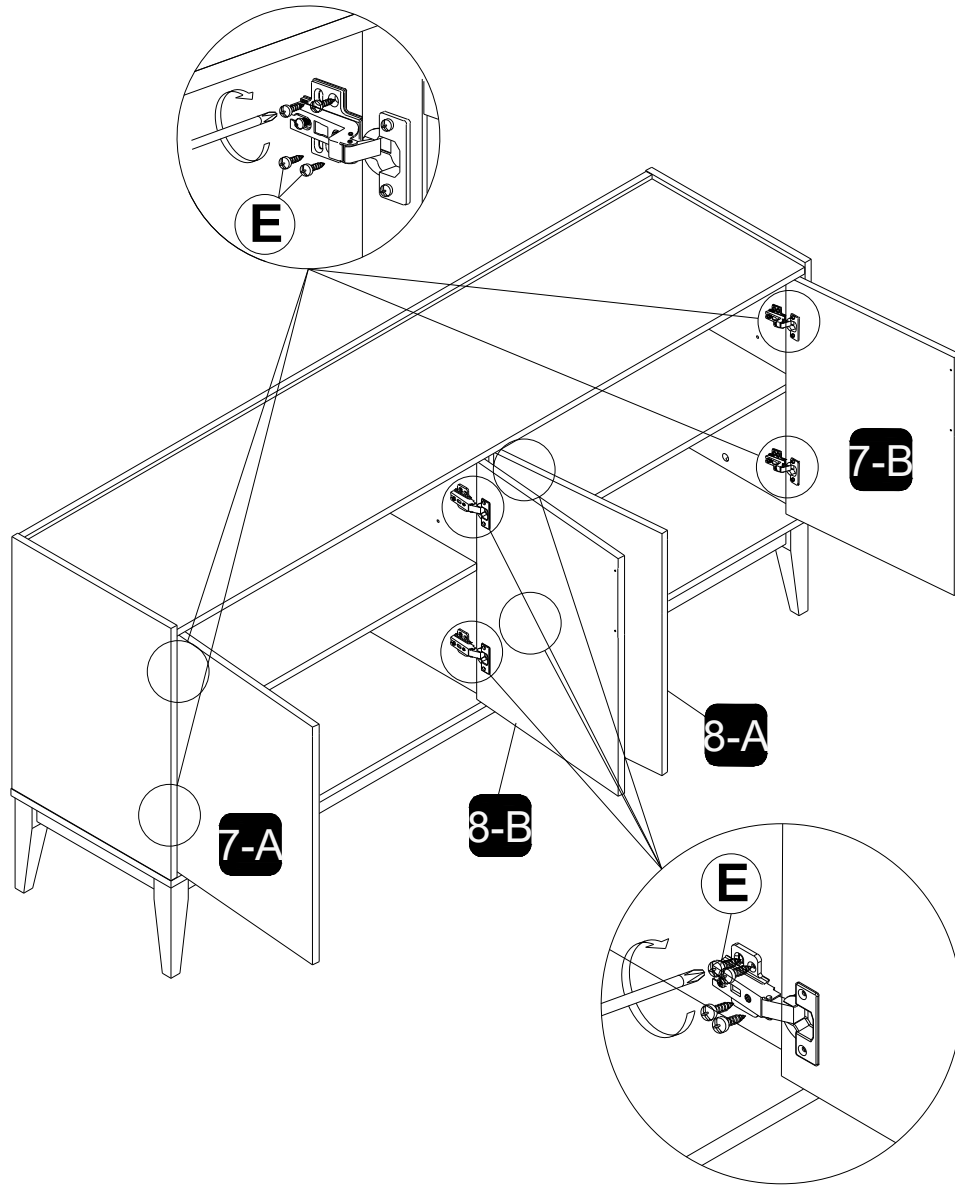

G X 8pcs

STEP 11



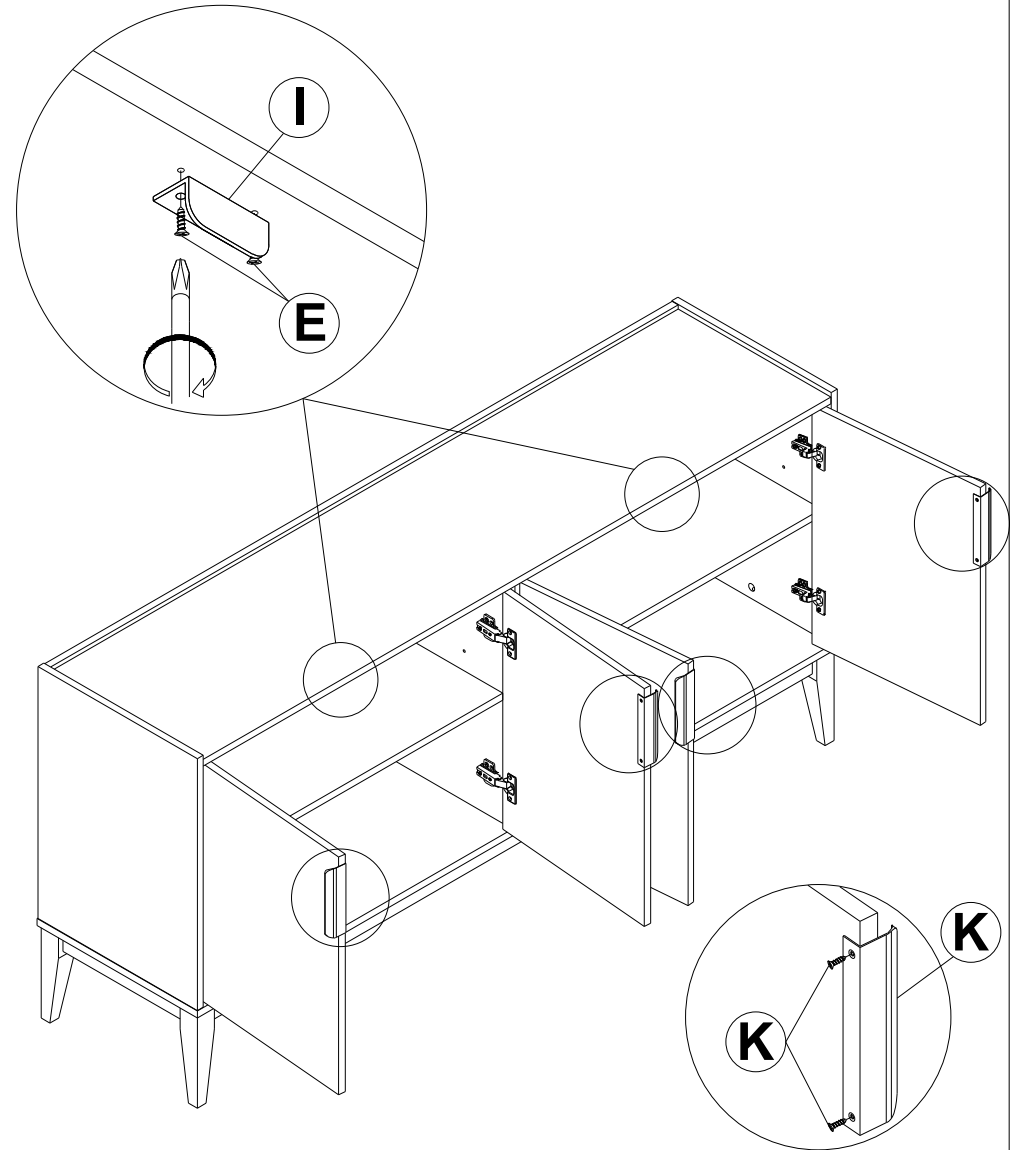

STEP 12



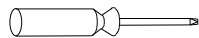

E X 32pcs



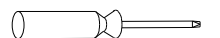

E X 4pcs

I X 2pcs

K X 4sets

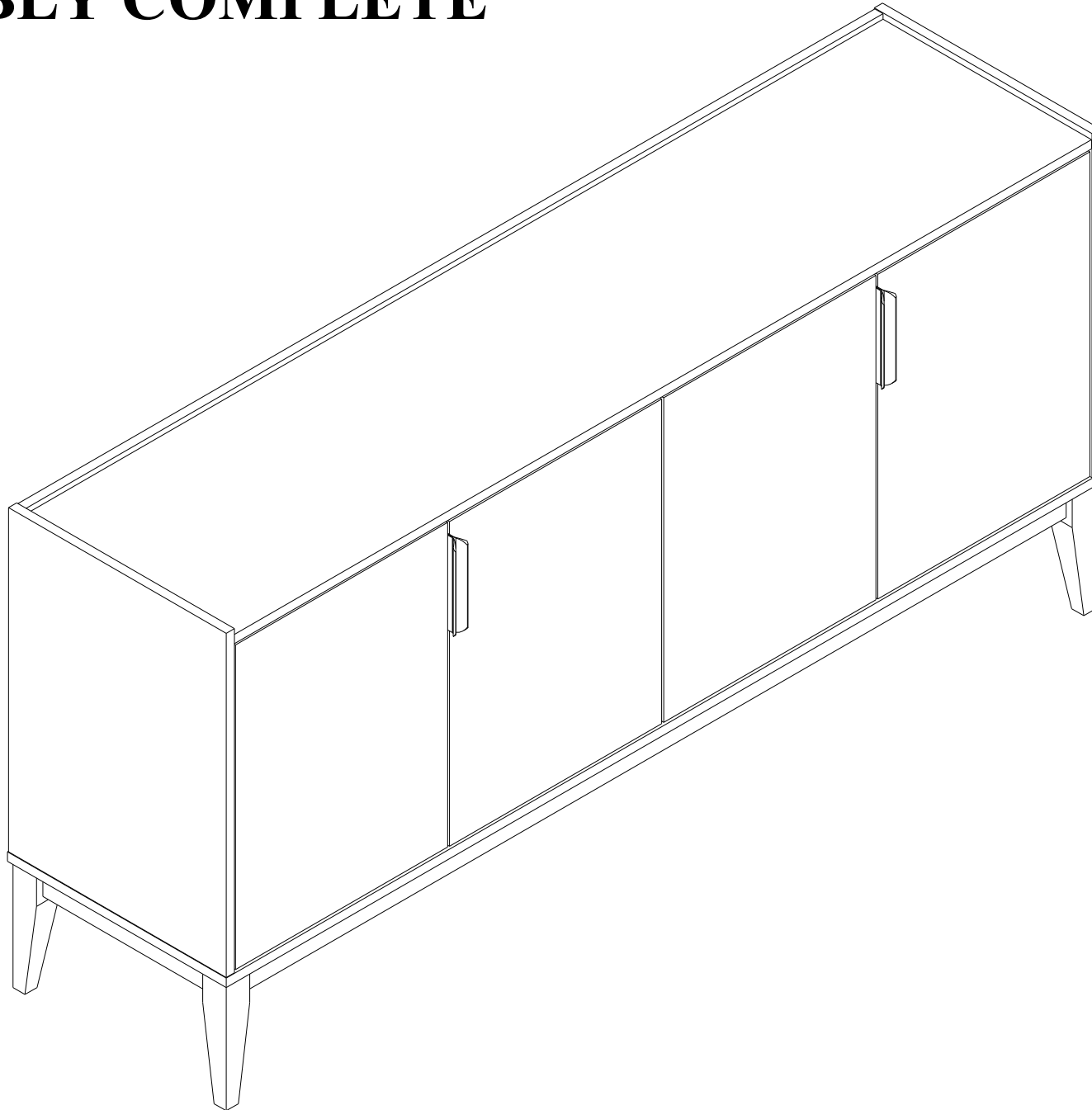

ASSEMBLY COMPLETE



ASSEMBLY INSTRUCTIONS

How to Concealed Hinges

Height Adjustment-helps you to adjust doors so they align at the top and bottom.

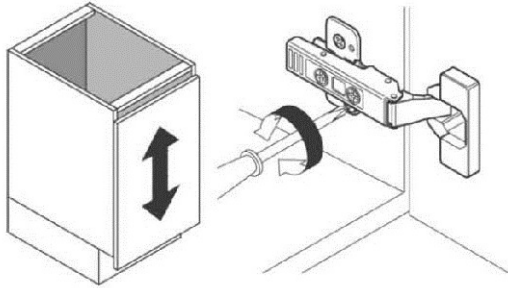

Note: Run your hand along the underside of the doors. You will easily feel which door are sitting lower than the others.

Depth Adjustment- Lets you bring a door into alignment with vertical surfaces such as drawers.

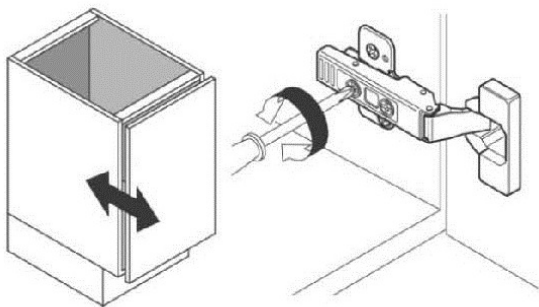

Note: Check to make sure you are not missing a door bumper. Missing door bumpers will cause your cabinet to look out of alignment.

Side Adjustment- adjusts gaps between doors and alleviates rubbing doors.

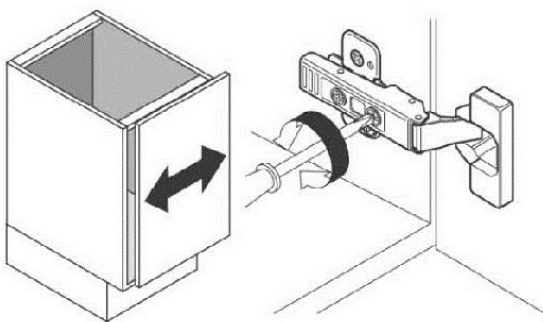

Note: Right Side Hinge: Clockwise moves door to RIGHT, CCW moves door to LEFT.
Left Side Hinge: Clockwise moves door to LEFT, CCW door to RIGHT.