

BEFORE INSTALLATION

- To insure proper installation, please read the following instructions carefully.
- Please make sure that the water supply has been shut off at the stop valve.
- EZANDA reserves the right to update product without notice.

If you have any question or need help,
please visit [EZANDA](http://www.ezanda.com) website
<http://www.ezanda.com>

1. Place the Spout in center hole of sink.
Secure it with washers and lock nut.

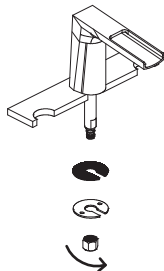

2. Connect the RED striped supply line with the Hot water handle labeled "H" while the blue one with the Cold water handle labeled "C".

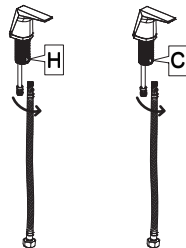

3. Attach each handle with a washer and a threaded ring.
Ensure the handles are in the OFF position Align the handles as shown.

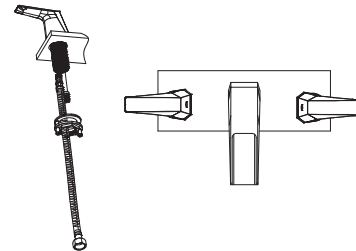

4. Align spout tube ① outlet tubes ② on quick connect hose ③. Push quick connect hose ③ firmly upward and snap onto tubes ① ②. Pull down moderately to ensure each connection has been made.

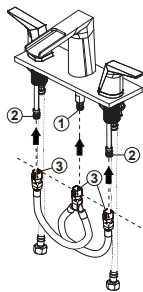

5. Connect to water supplies.

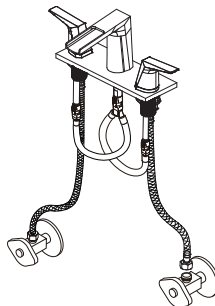

6. Turn on the water supplies.
Check all connections for leaks.

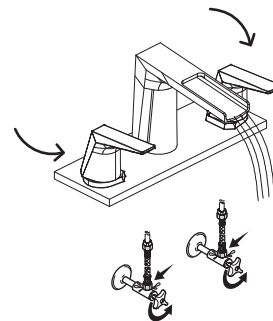

· Every once in a while, please rinse the faucet with lukewarm soapwater, and wipe it clean with a soft duster cloth.
Please avoid any abrasive cleaners, steel wools, or corrosive chemicals.



NOTES:

- Fits for sink WITH overflow hole.
- Clean the sink hole, make sure to remove debris.
- Please avoid using plumber's putty. The seal on top is leak-free. Plumber's putty might cause damage.
- Silicone and plumbing tape can be use for sealing requirement.

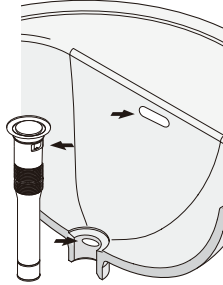

1 Unscrew components A & B to the seal.

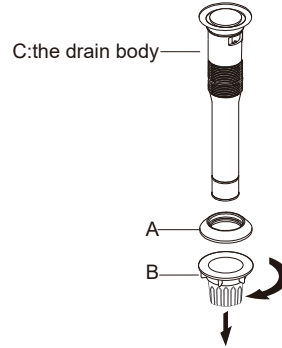

2 Slide the drain body C through the hole in the sink.

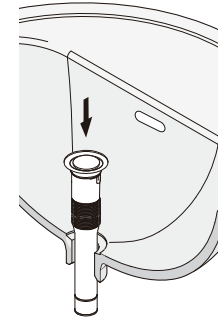

3 Screw components A & B back on as shown.

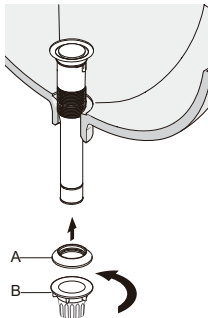

4 Connect the rear end of the drain to the Drain Pipe.

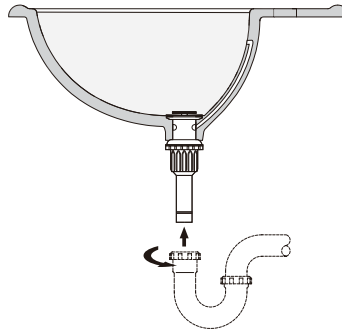

5 Push to activate.

