

ASSEMBLY INSTRUCTIONS

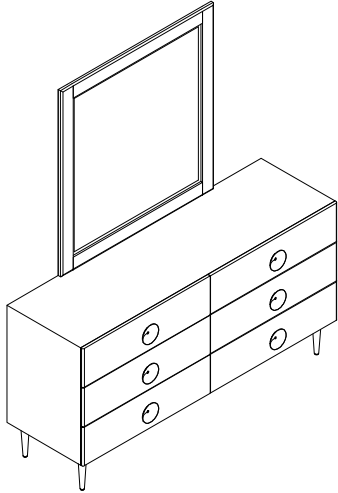

+ Parts Included

① Frame Mirror *1pcs

② Support slat *2pcs

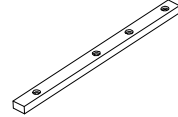
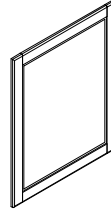

③

④

⑤

⑥

+ Do Not Use Power Tools

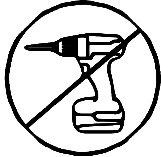

+ Suggested Adults

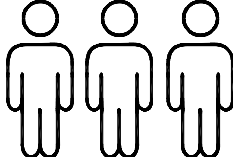

NOTE:

- 1 Read instructions cover to cover.
- 2 Save all packaging until assembly is completed

1 IMPORTANT SAFETY INFORMATION

Do not assemble the product if any of the following parts arrived damaged:

Part# - Frame Mirror

Part# - Support slat

Part# -

Do not assemble if any of the following Hardware parts are missing:

Part# -Bolt

Part# -Allen Key

Part# -

2 IMPORTANT ASSEMBLY INFORMATION

Assembly Step If loosening persists, please make sure to tighten all the bolts periodically, or use a thread locker adhesive.

+ Hardware Included

A Allen Wrench *1pcs

B Bolt *8pcs

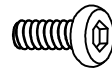
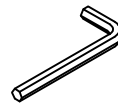

C Lock Washer *8pcs

D Flat Washer *8pcs



E

F

G

ASSEMBLY INSTRUCTIONS

①

