

Storage Cabinet

Instruction Manual

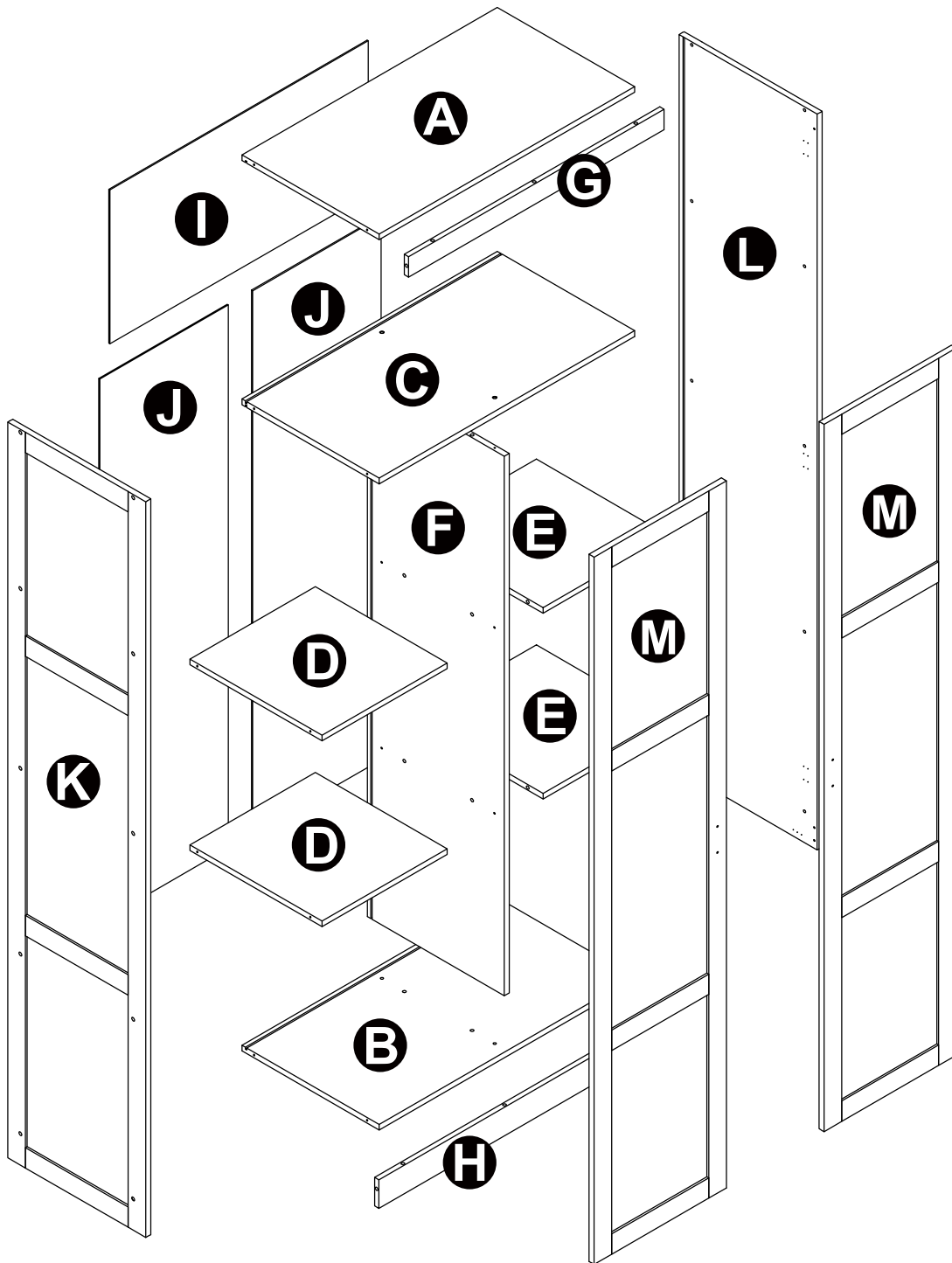

EXPLODED VIEW



PARTS LIST

Ax1

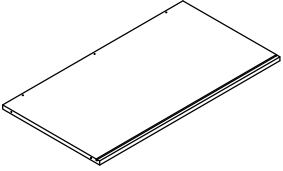

Bx1

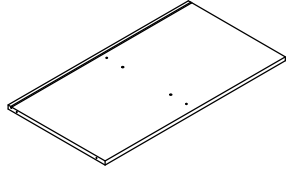

Cx1

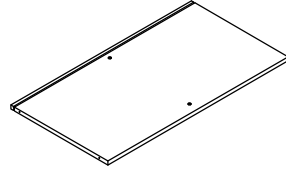

Dx2

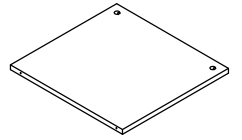

Ex2

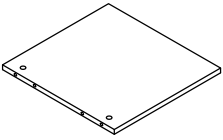

Fx1



Gx1

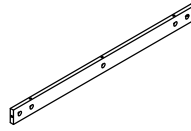

Hx1

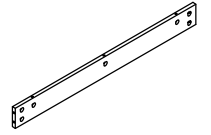

Ix1

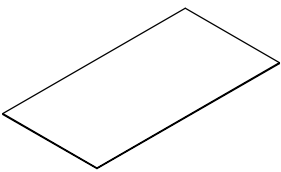

Jx2



Kx1



Lx1

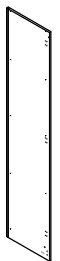

Mx2

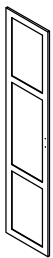

HARDWARE

1x20+1

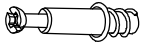

M6x34mm

2x20+1



M15x9.5mm

3x12+1

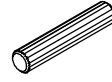

M8x30mm

4x4

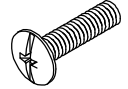

M5/32"x12mm

5x36+2



Nickel color
M3.5x12mm

6x6

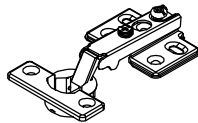

7x2

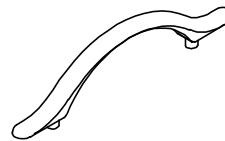

8x24+1

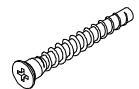

M9.5*6.2*40mm

9x1

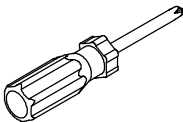

10x2

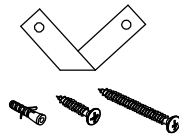

11x1

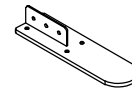

Left Support Foot

12x1

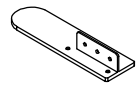

Right Support Foot

13x16

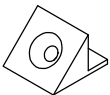

14x28



Zinc Color
M3.5x12mm

15x20

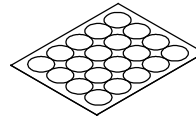

Please have the following auxiliary tools ready.
Bitte halten Sie folgende Hilfswerkzeuge bereit.
Veuillez préparer les outils auxiliaires suivants .
Si prega di avere pronti i seguenti strumenti ausiliari.
Por favor, tenga listas las siguientes herramientas auxiliares.

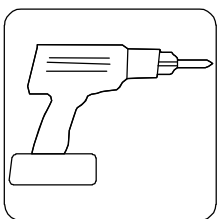

Electric Drill

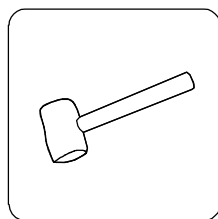

Hammer

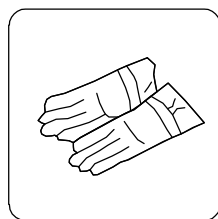

Gloves

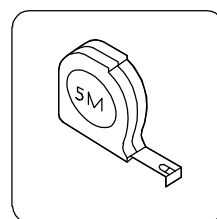

Tape Measure 5M

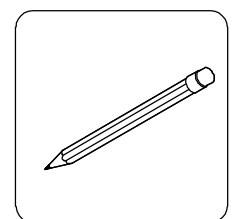

Pencil

NOTE: This product requires at least two people for installation.

ASSEMBLY INSTRUCTION

STEP 1

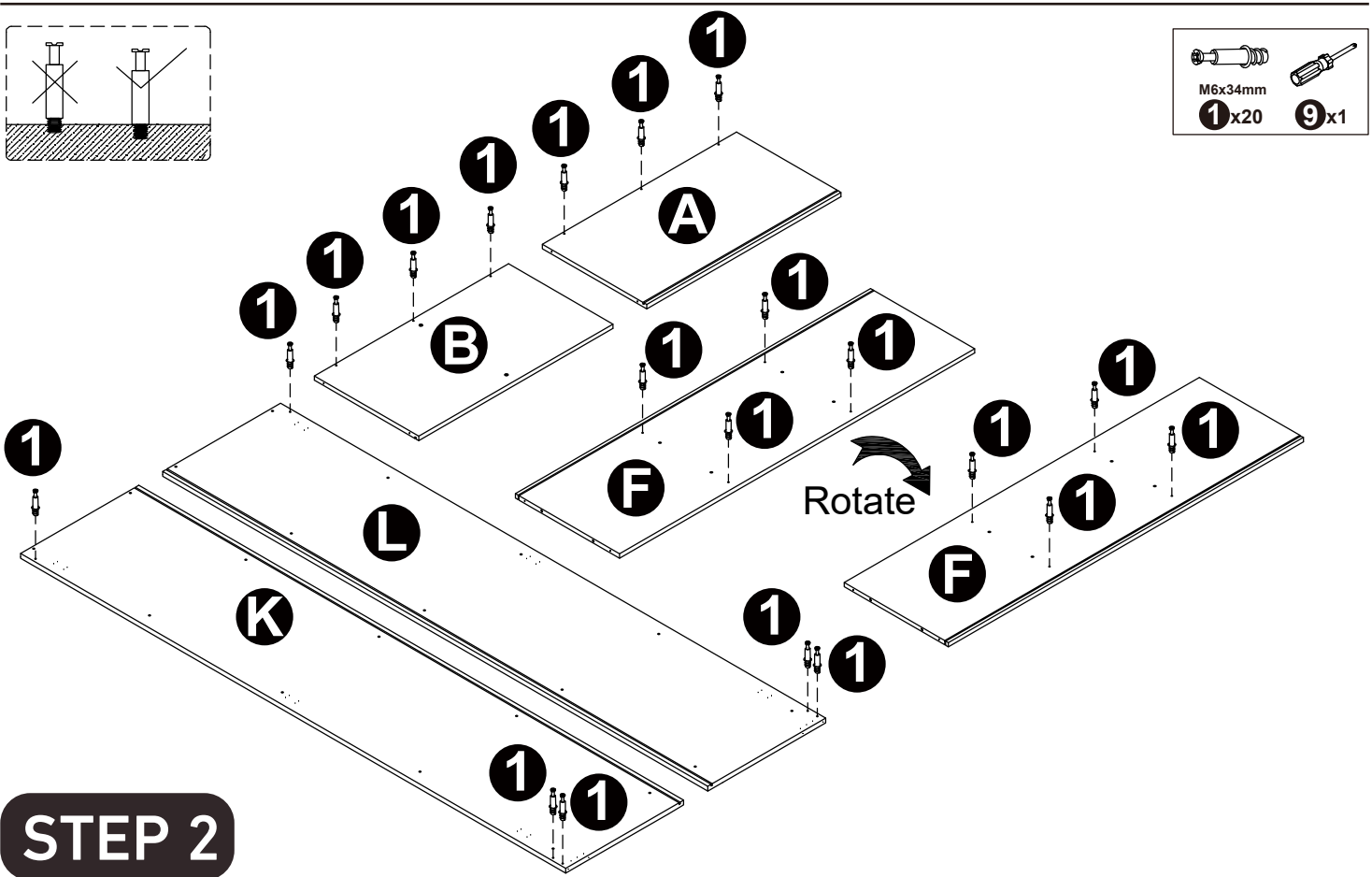

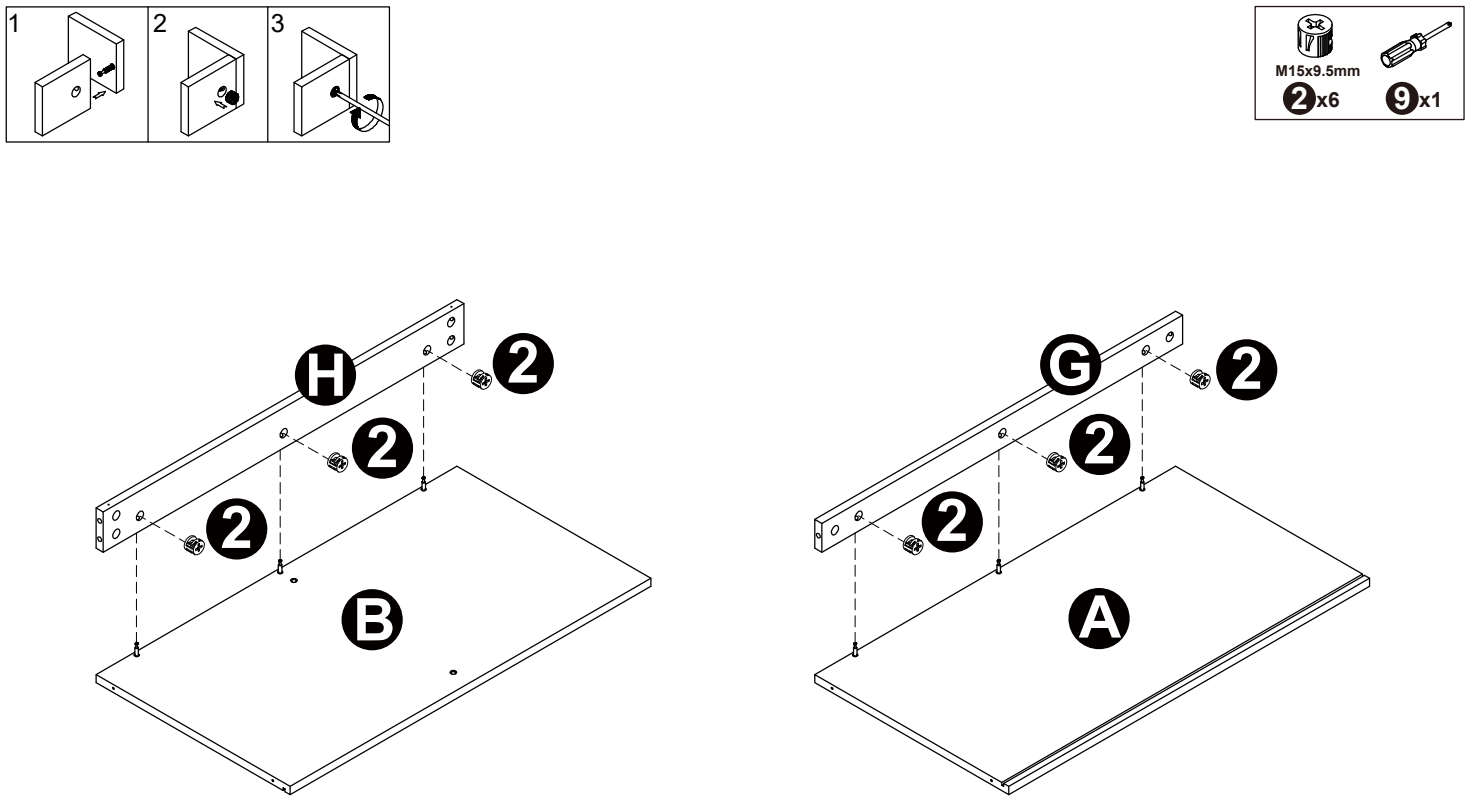

STEP 2



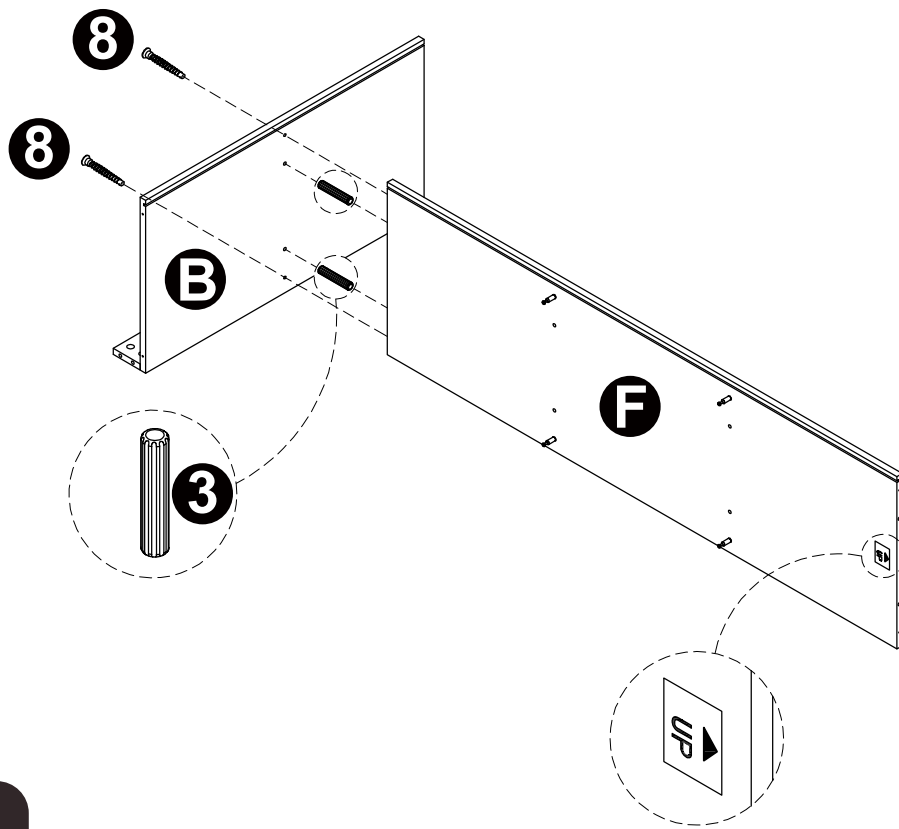



STEP 3



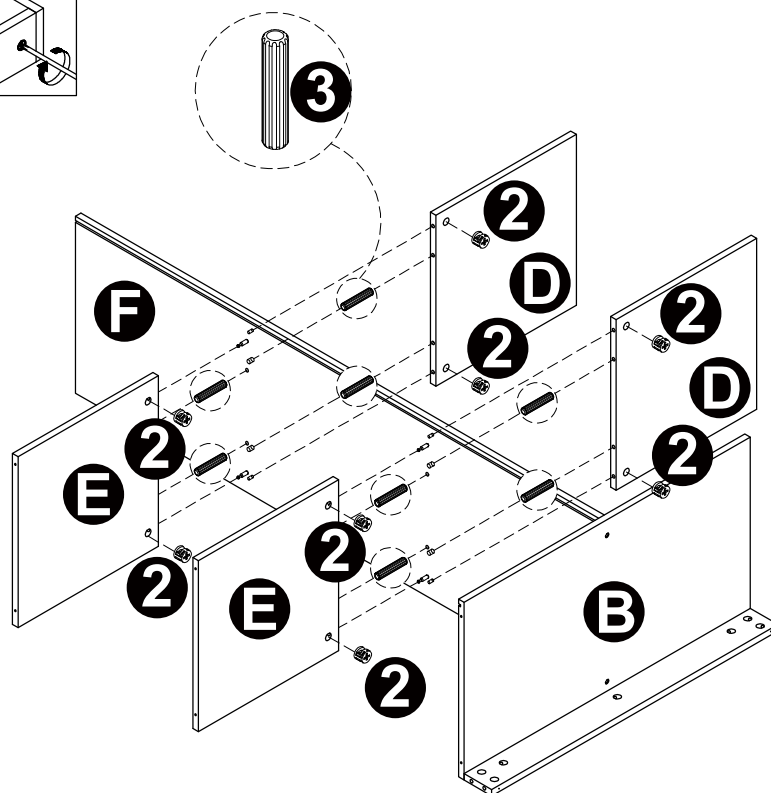
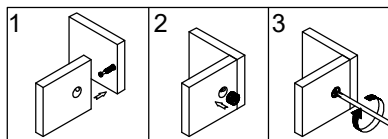

		
M8x30mm	M9.5*6.2*40mm	
3 x2	8 x2	9 x1

STEP 4



		
M8x30mm	M15x9.5mm	
3 x8	2 x8	9 x1

STEP 5

 M9.5*6.2*40mm 8 x6	 M15x9.5mm 2 x2	 9 x1
---	---	--

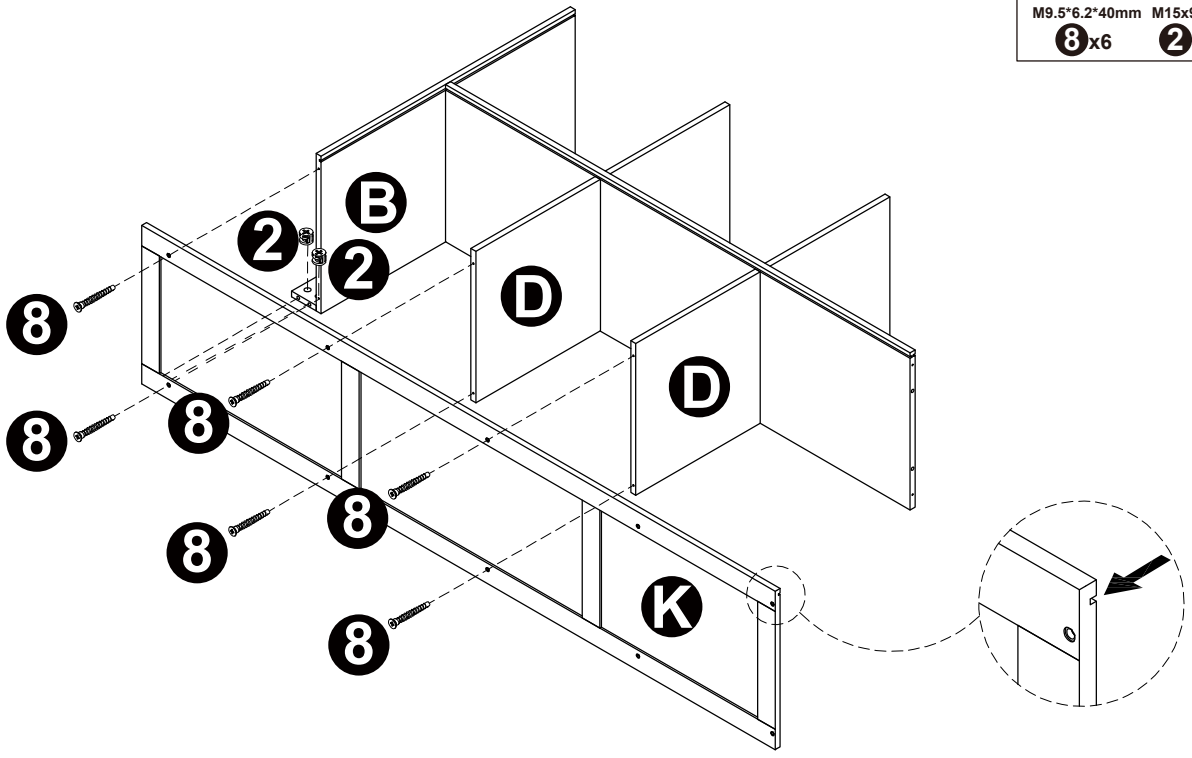

STEP 6

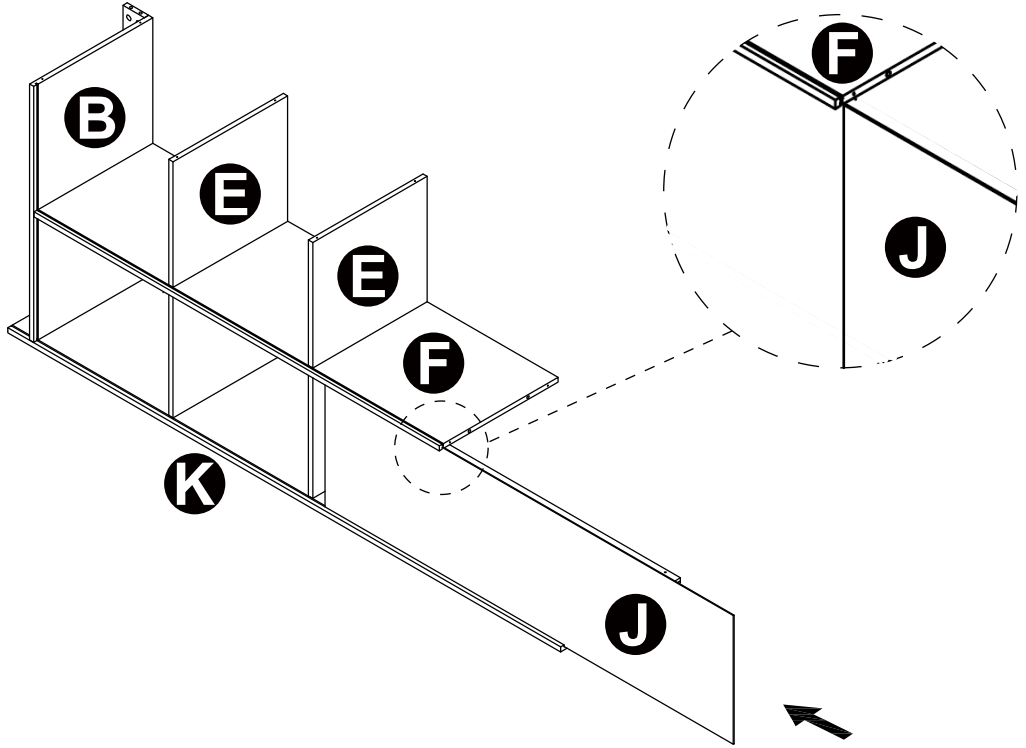
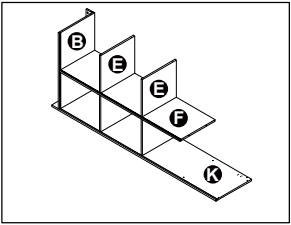
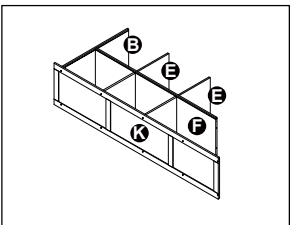

STEP 7

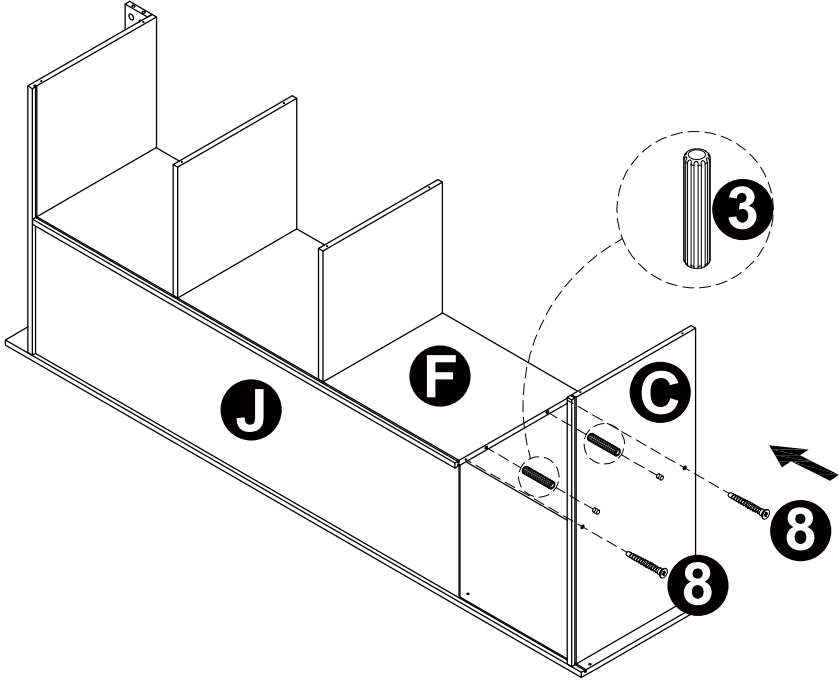
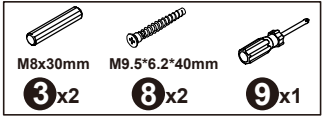

STEP 8

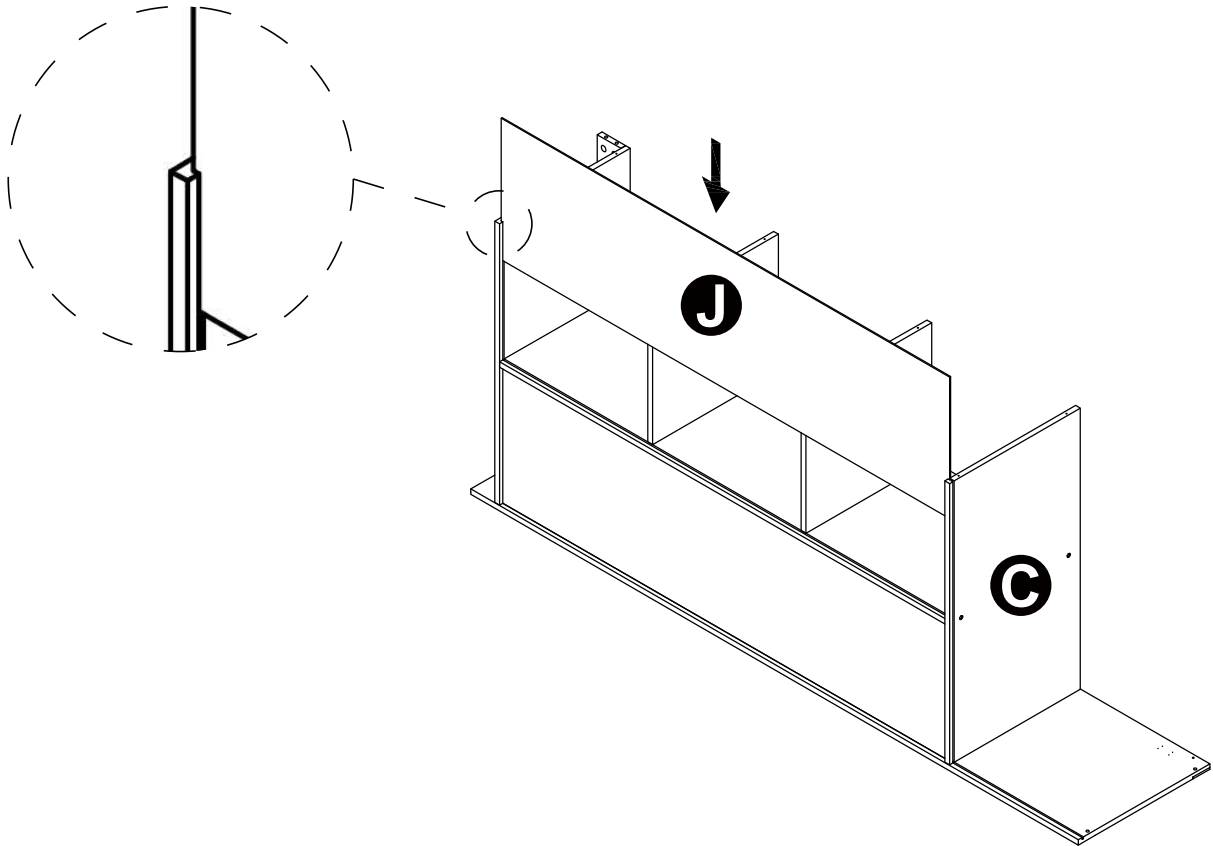

STEP 9

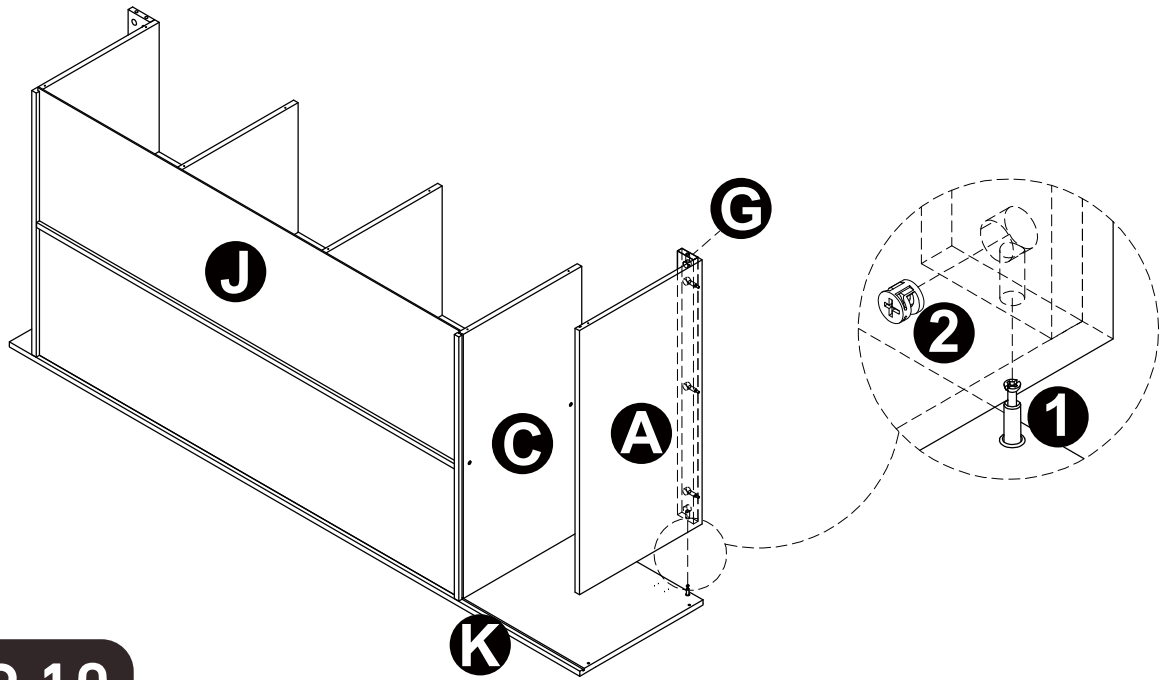
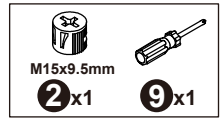
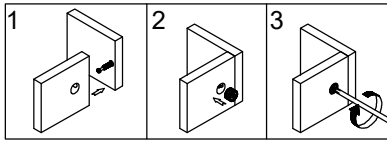

STEP 10

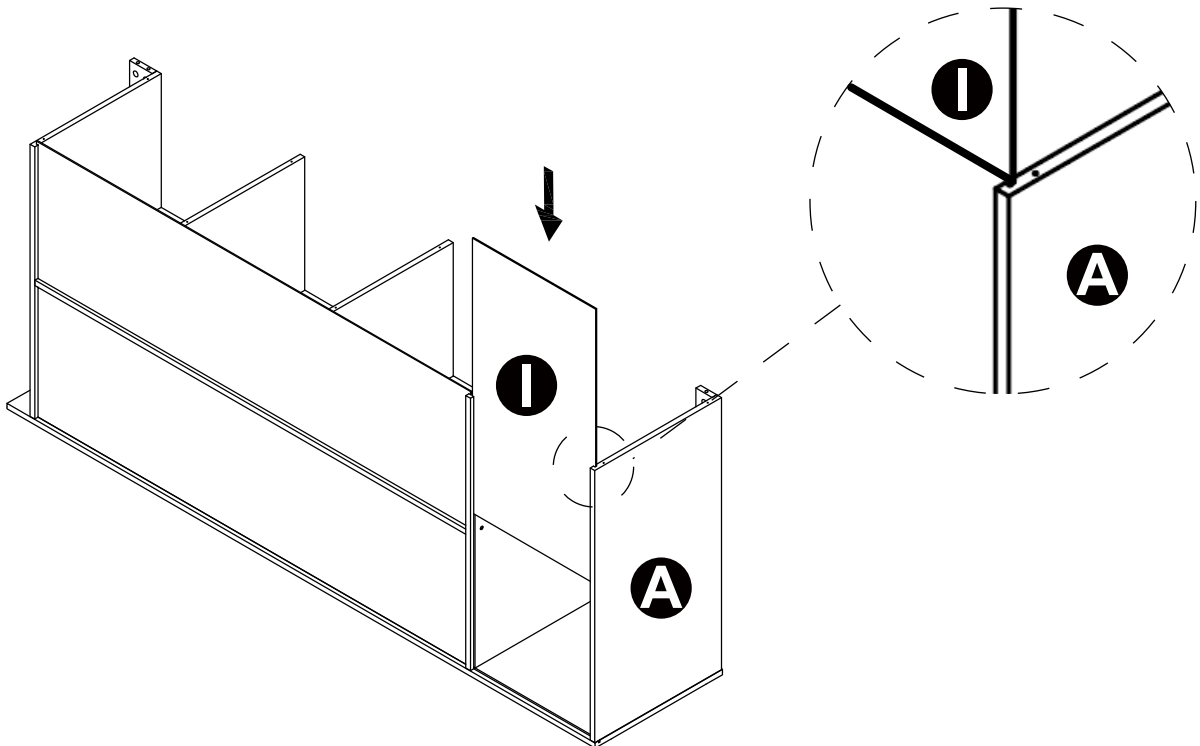

STEP 11

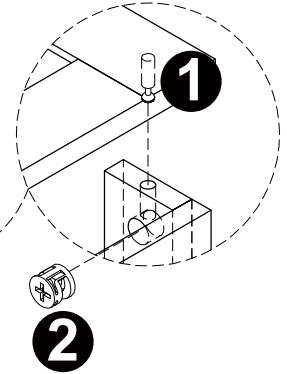
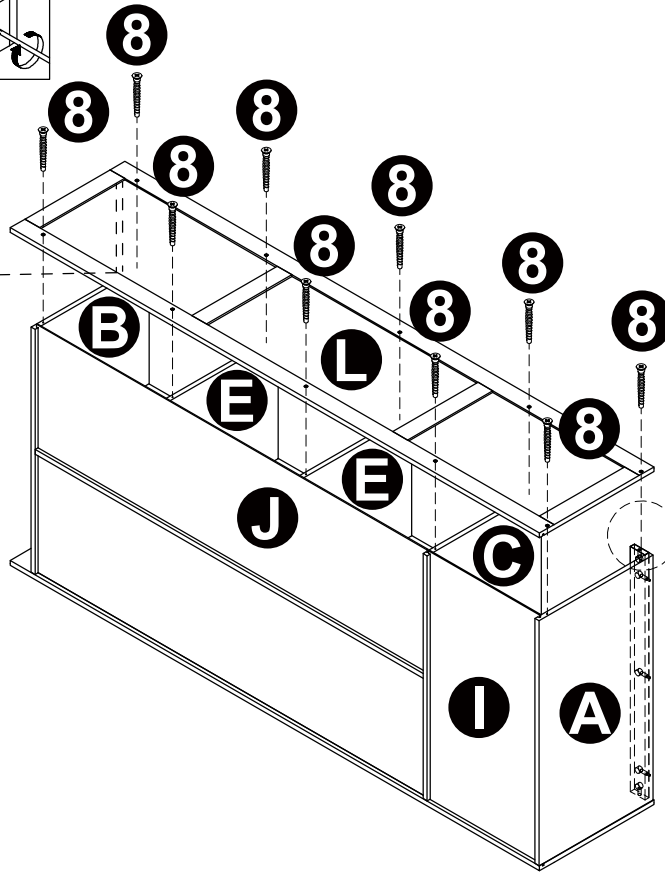
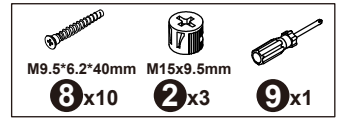
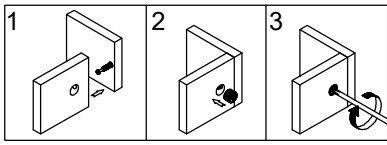

STEP 12

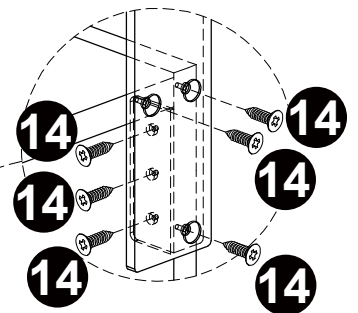
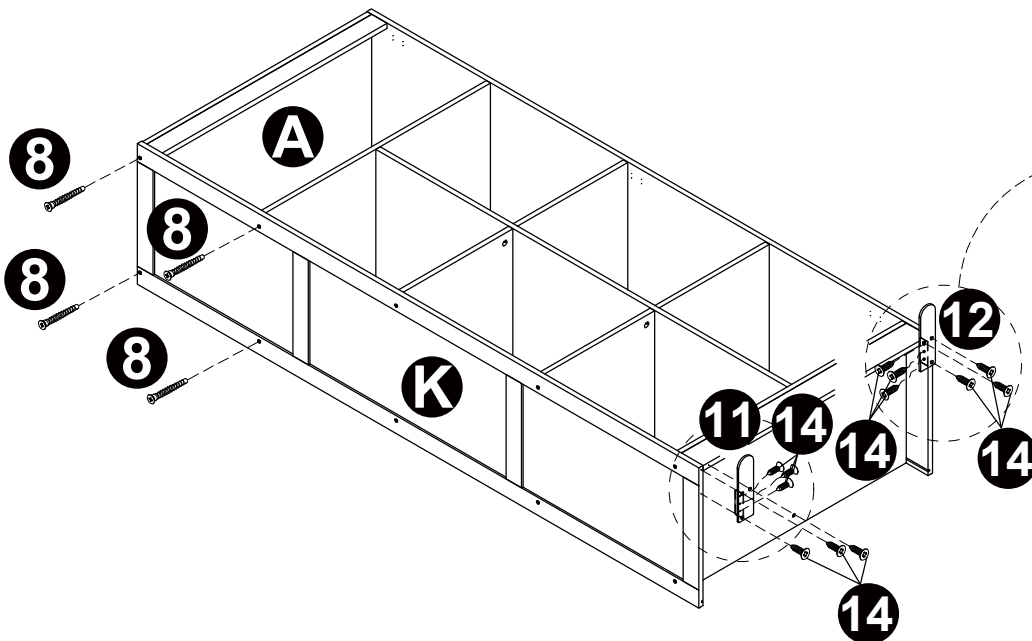

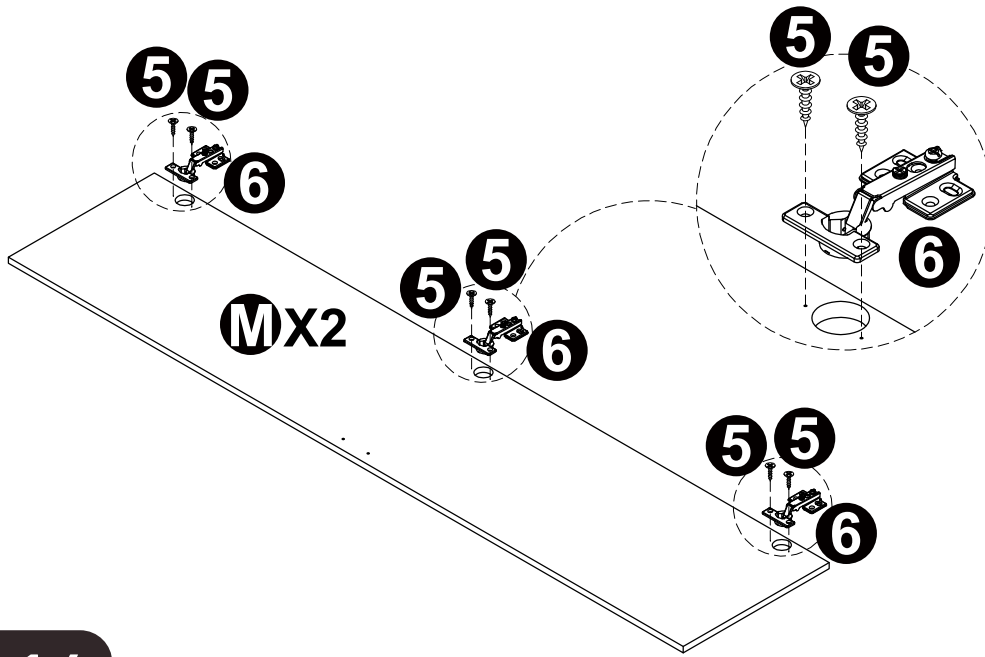
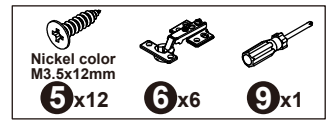

STEP 13

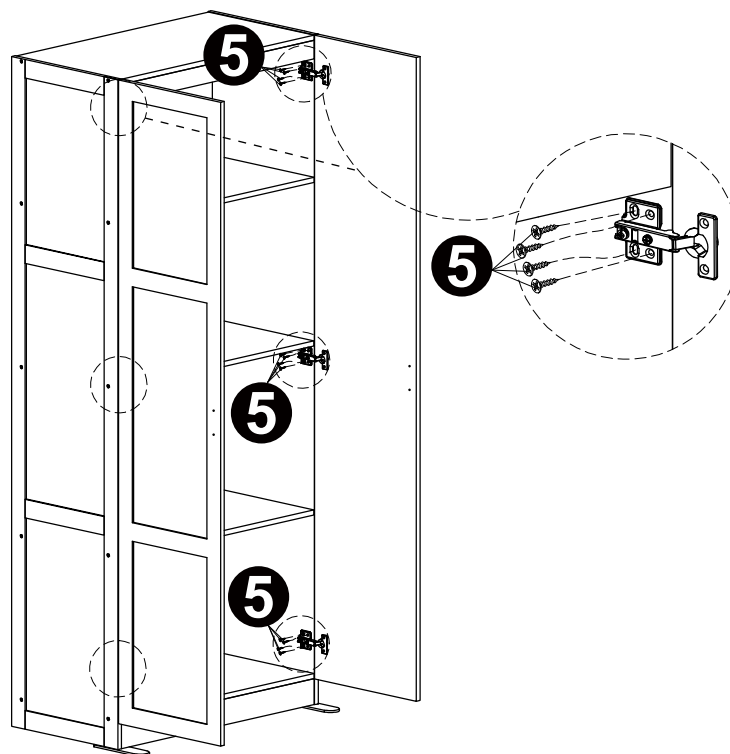
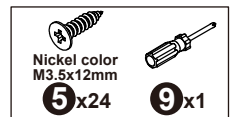

STEP 14



STEP 15

 M5/32"x12mm		
4 x4	7 x2	9 x1

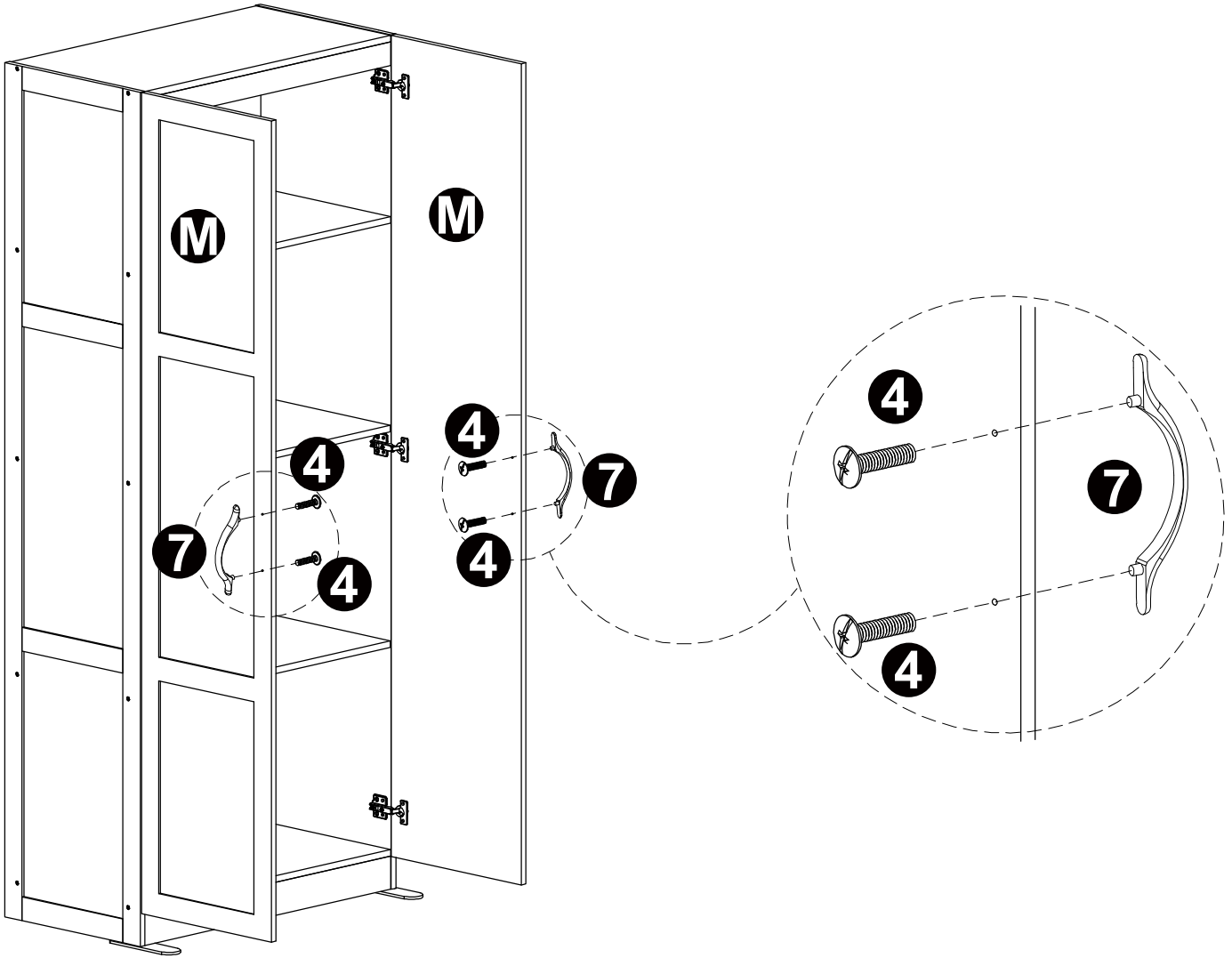

STEP 16

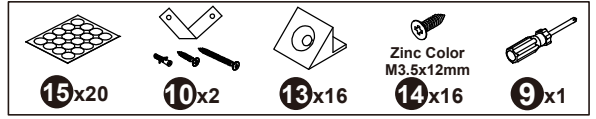

Secure the strap to the cabinet with the short screws.

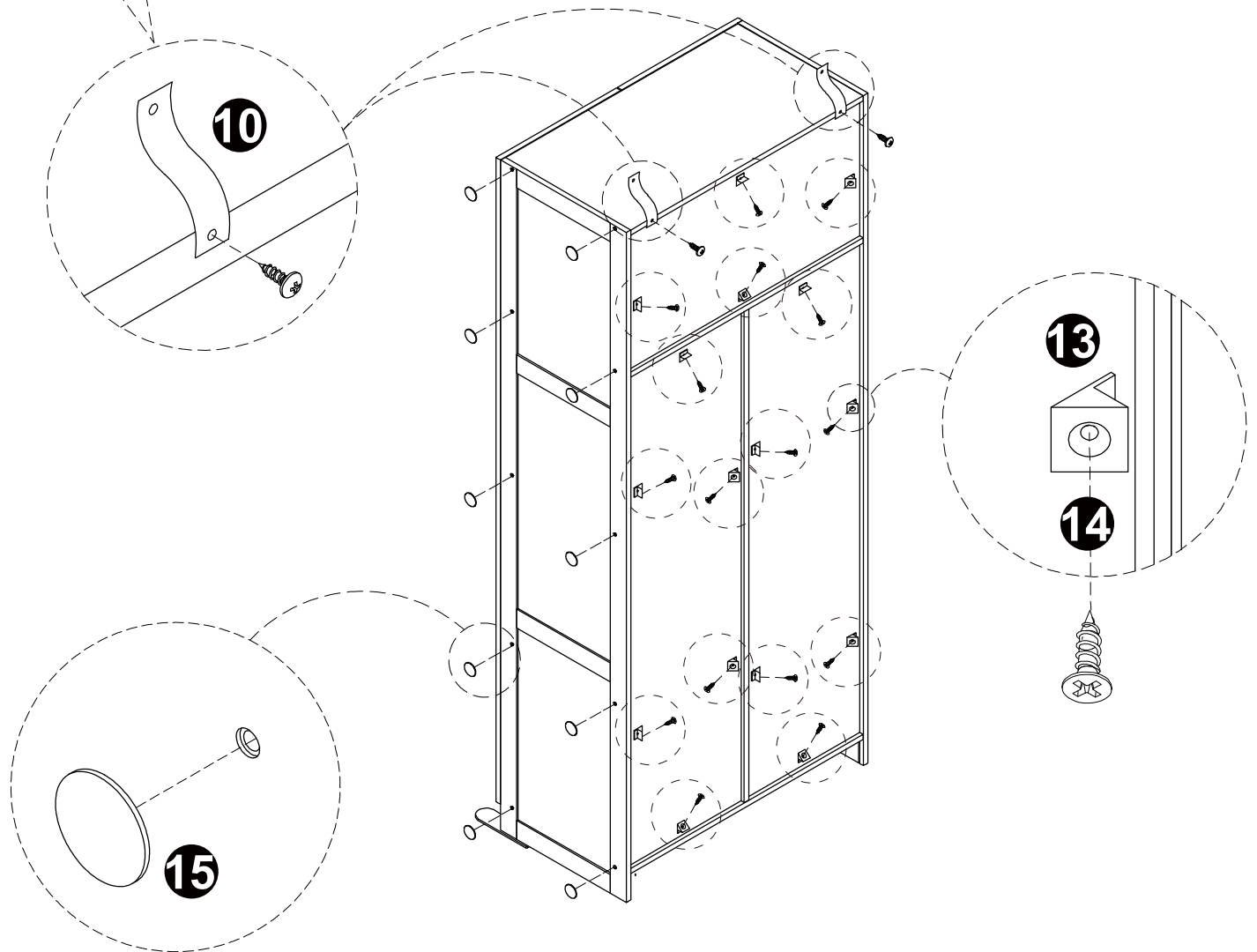

STEP 17

Install the anti-tip kit

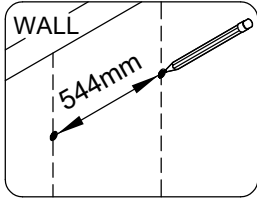
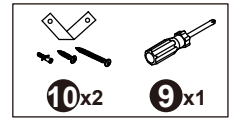

1. Make mark on the wall

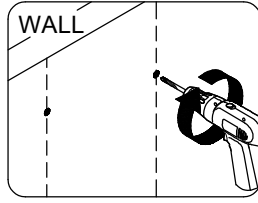

2. Drill two Ø6mm holes on the wall

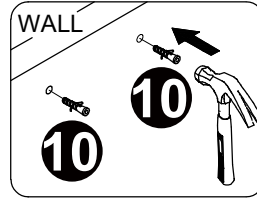

3. Insert two anchors in the holes

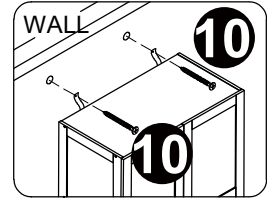

4. Insert the long screws through the strap into the holes

NOTE: Pencil, electric drill, and hammer are not included.

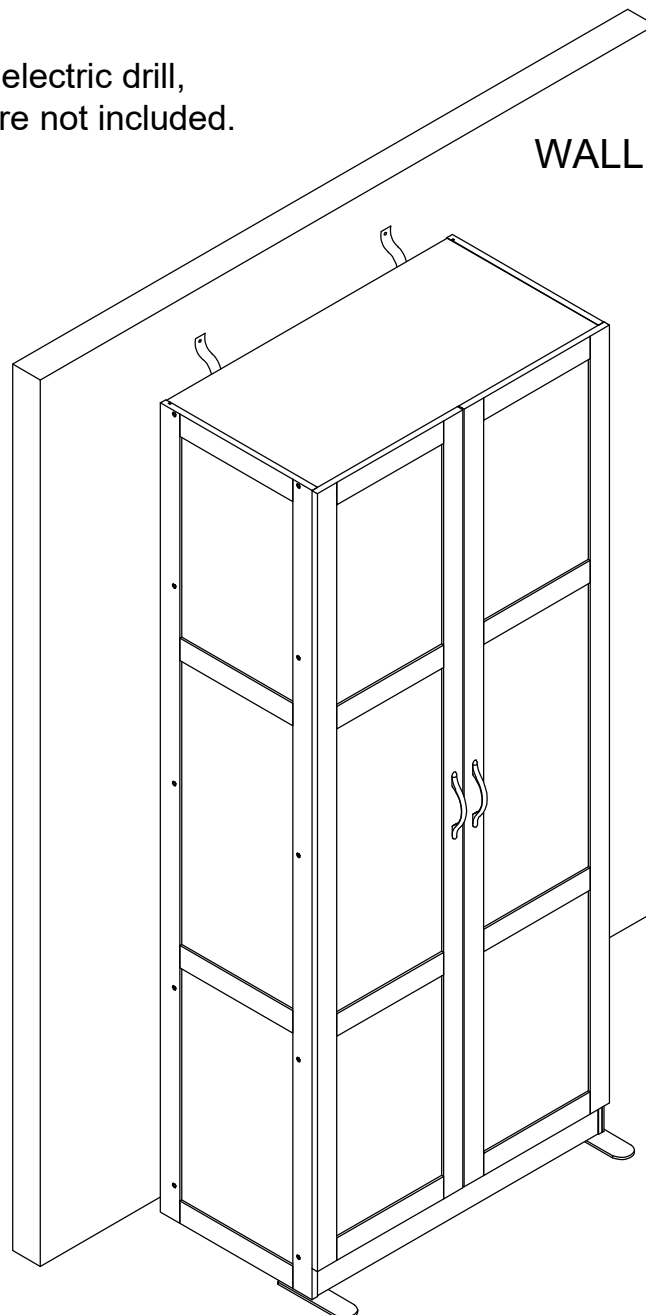

STEP 18

