

ASSEMBLY INSTRUCTIONS

012-915



TOOLS REQUIRED:

Allen Wrench (supplied, part # D)

BEFORE YOU START:

1. Check the parts against the parts list to make sure all items are present.
2. Assemble your furniture on a soft, flat surface to avoid scratching the finish.
3. CAUTION: Do not over tighten screws, nuts or bolts during assembly.
4. Your furniture may require occasional tightening.

INSTRUCTIONS:

1. Turn the table on the smooth and clean soft surface.
2. Attach three legs to top panel using Bolt (C), Lock washer (B), Flat washer (A) and Tighten with Allen Wrench(D). As show in Figure 1.
3. Put the bottom shelf onto the legs . As show in Figure 2.
4. Attach the last leg to top panel, using Bolt(C),Lock Washer (B), Flat Washer (A) and tighten with Allen Wrench (D). As show in Figure 3.

Figure 1

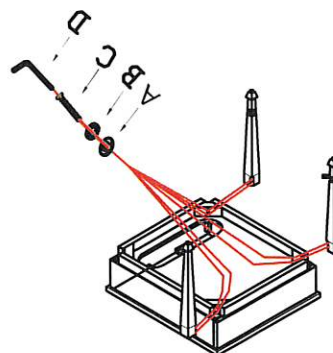

Figure 2

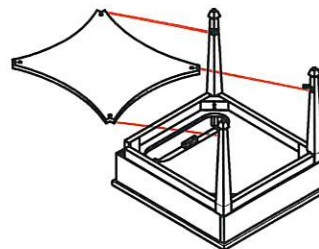
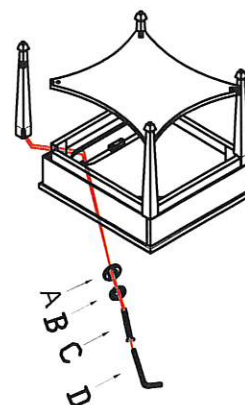

Figure 3



ASSEMBLY INSTRUCTIONS

012-915



INSTRUCTIONS:

5. Tighten the shelf using Bolt (E), Lock washer (B), Flat washer (A) and Tighten with Allen Wrench(D). As show in Figure 4.

6. Tighten all bolts before using the table.

Figure 4

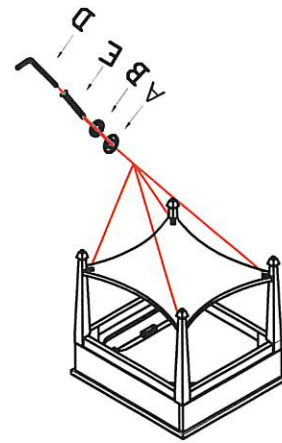

NO	DRAWING	DESCRIPTION	SIZE	Q'ty
A		Flat washer	ø5/16"	12pcs
B		Lock washer	ø5/16"	12pcs
C		Bolt	5/16" * 60mm	8pcs
D		Allen Wrench		1pc
E		Bolt	5/16" * 19mm	4pcs

