

ASSEMBLY INSTRUCTIONS

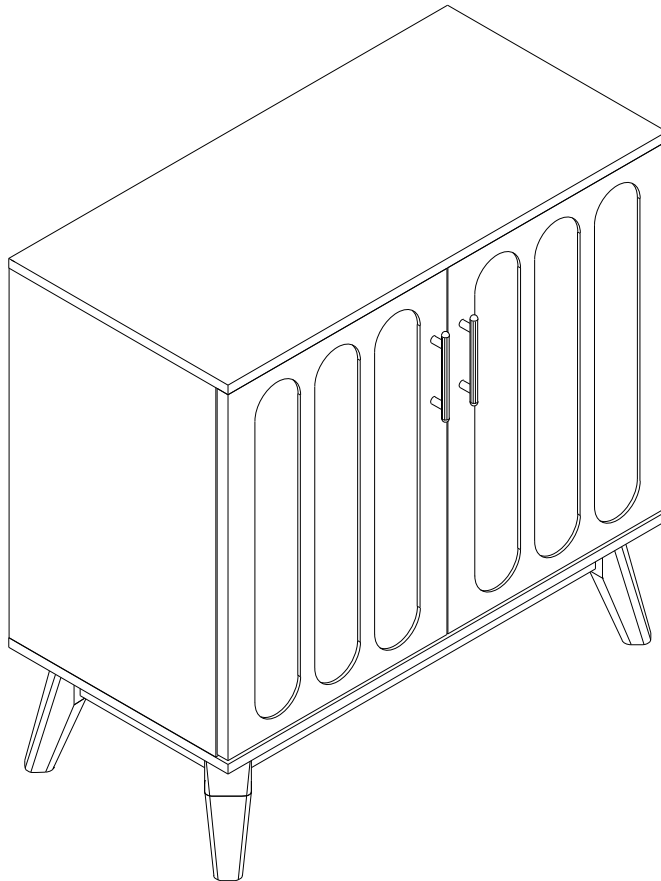

Notice:

1. Follow the installation instructions. Please confirm all accessories are preset before installation.
2. Do not fully tighten the screws during initial assembly. Fully tighten screws only once all pieces which are correctly assembled.
3. If you encounter any problems during installation, please contact our customer service.
4. Please unbox the item from the side with an open-label and put a carpet on the floor to avoid scratching it.

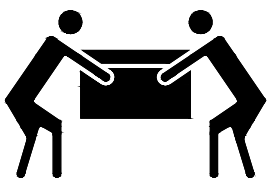

Recommended installers:2

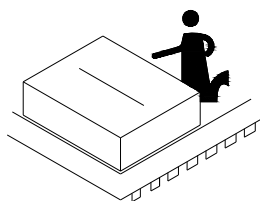

Put a carpet on the floor
before unpacking

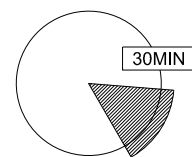

Estimate installation time:
30minutes





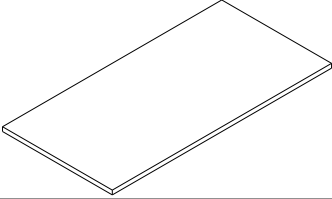
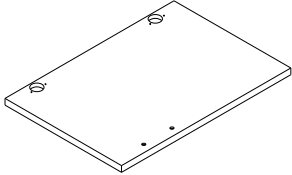
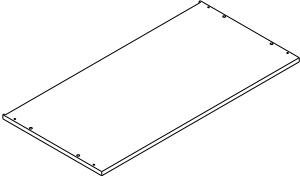
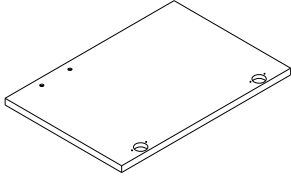
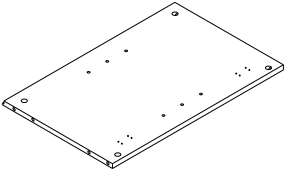
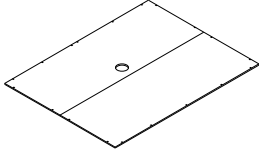
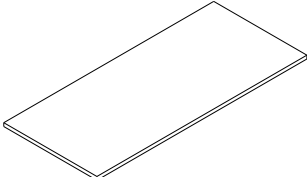
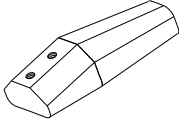

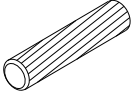
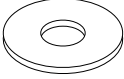
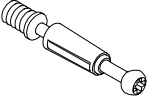

ASSEMBLY INSTRUCTIONS

PART LIST

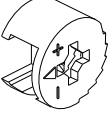
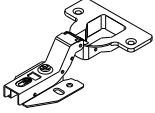
Item no.	Reference Image	Qty	Item no.	Reference Image	Qty
Ⓐ		X1	Ⓔ		X1
Ⓑ		X1	Ⓕ		X1
Ⓒ		X2	Ⓖ		X1
Ⓓ		X1	Ⓗ		X4

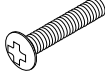
ASSEMBLY INSTRUCTIONS

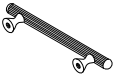
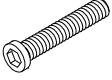
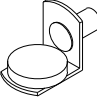
HARDWARE LIST

Item no.	Reference Image	Qty	Item no.	Reference Image	Qty
1	 Ø8*30mm	X8	8		X8
2		X8	9		X1
3		X8	10		X4
4	 Ø6.5*Ø3*15mm	X18+1	11		X4
5	 Ø6*Ø3*14mm	X24+2	12		X2
6	 Ø1/4*1-3/4"	X8	13		X4
7		X8	14		X1

ASSEMBLY INSTRUCTIONS

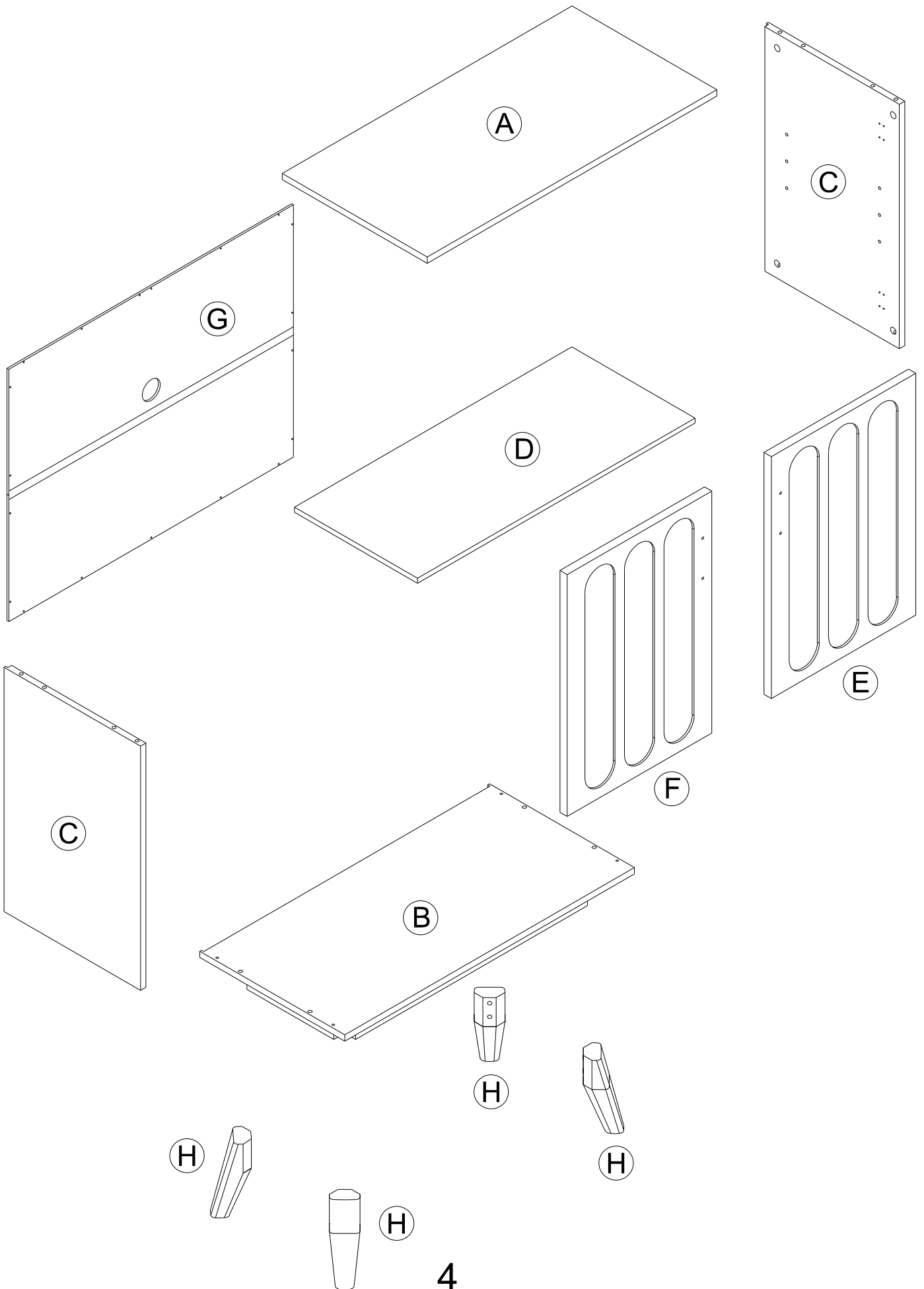

ASSEMBLY INSTRUCTIONS

2

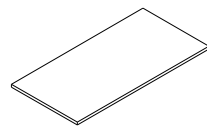

(A) 1pc

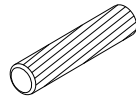

(1) 8pcs

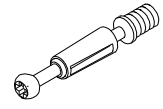

(2) 8pcs

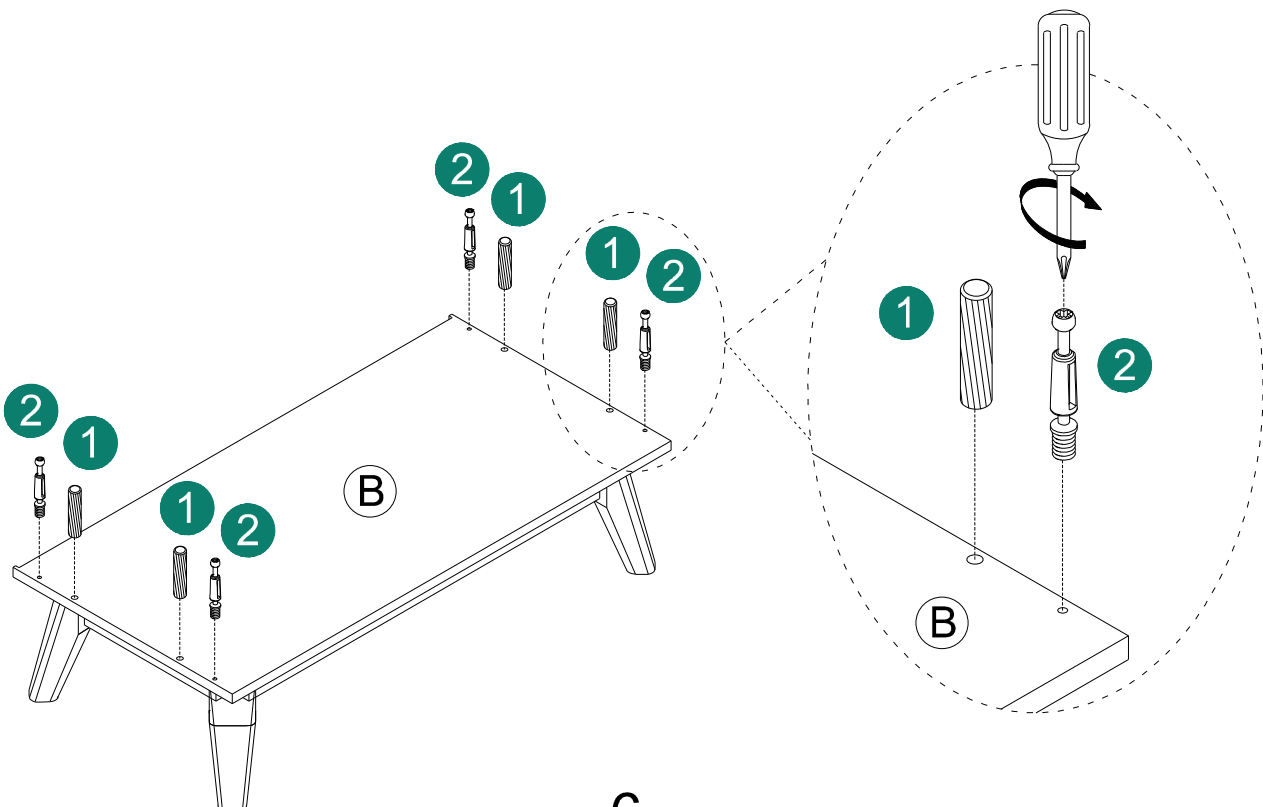
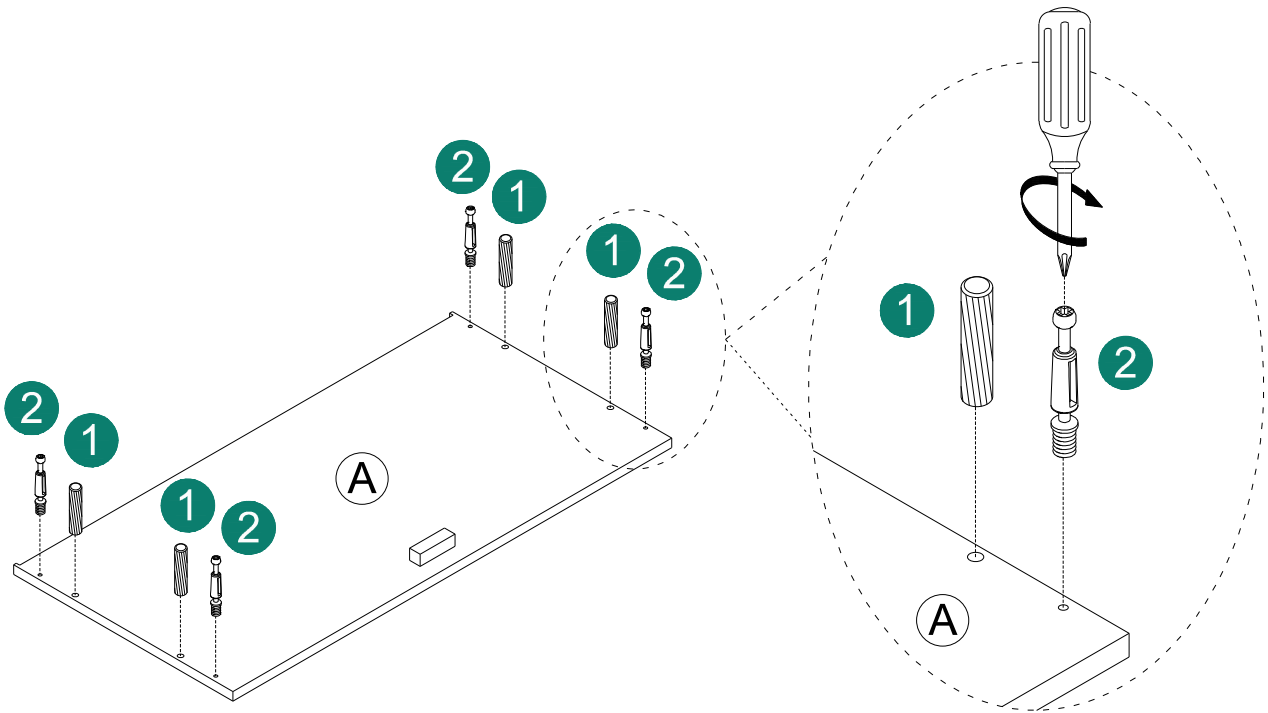

ASSEMBLY INSTRUCTIONS

3

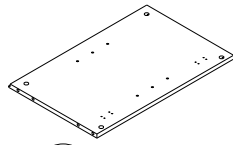

C 2pc

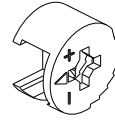

3 8pcs

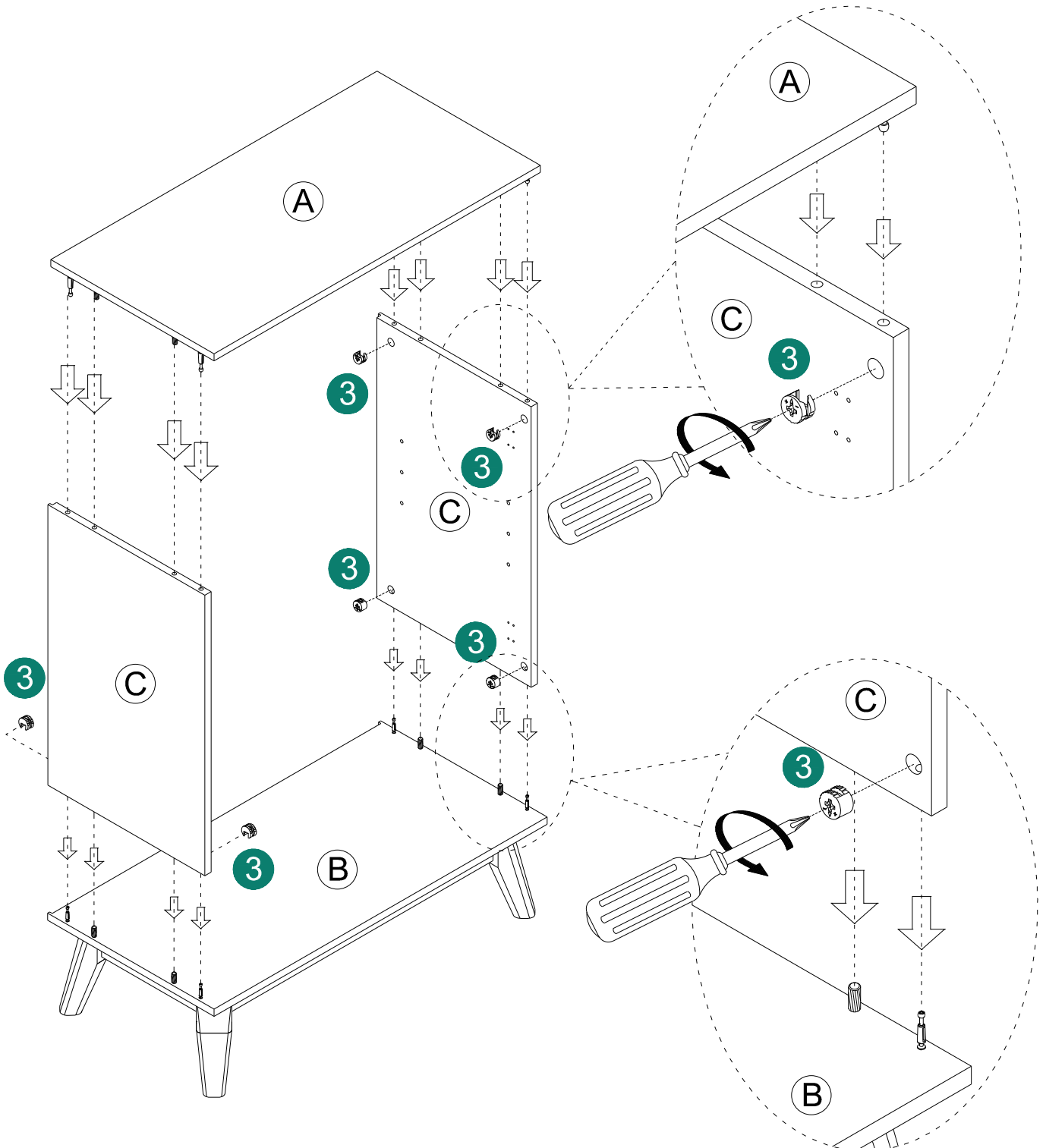

ASSEMBLY INSTRUCTIONS

4

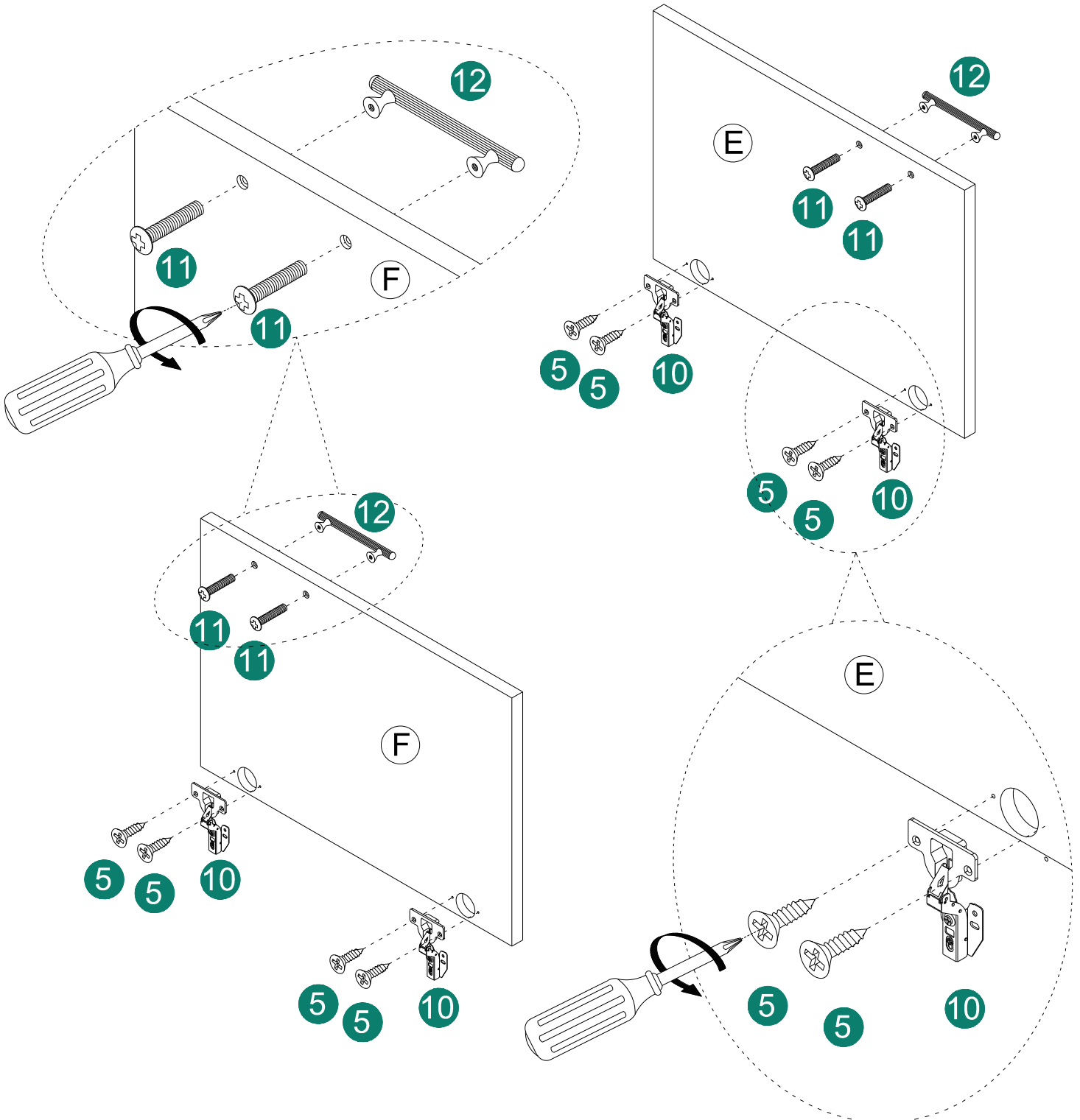
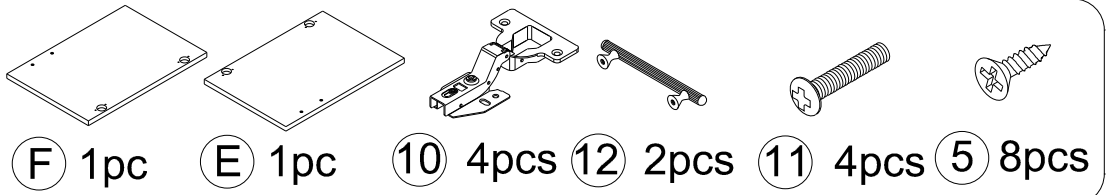

ASSEMBLY INSTRUCTIONS

5



5 8pcs

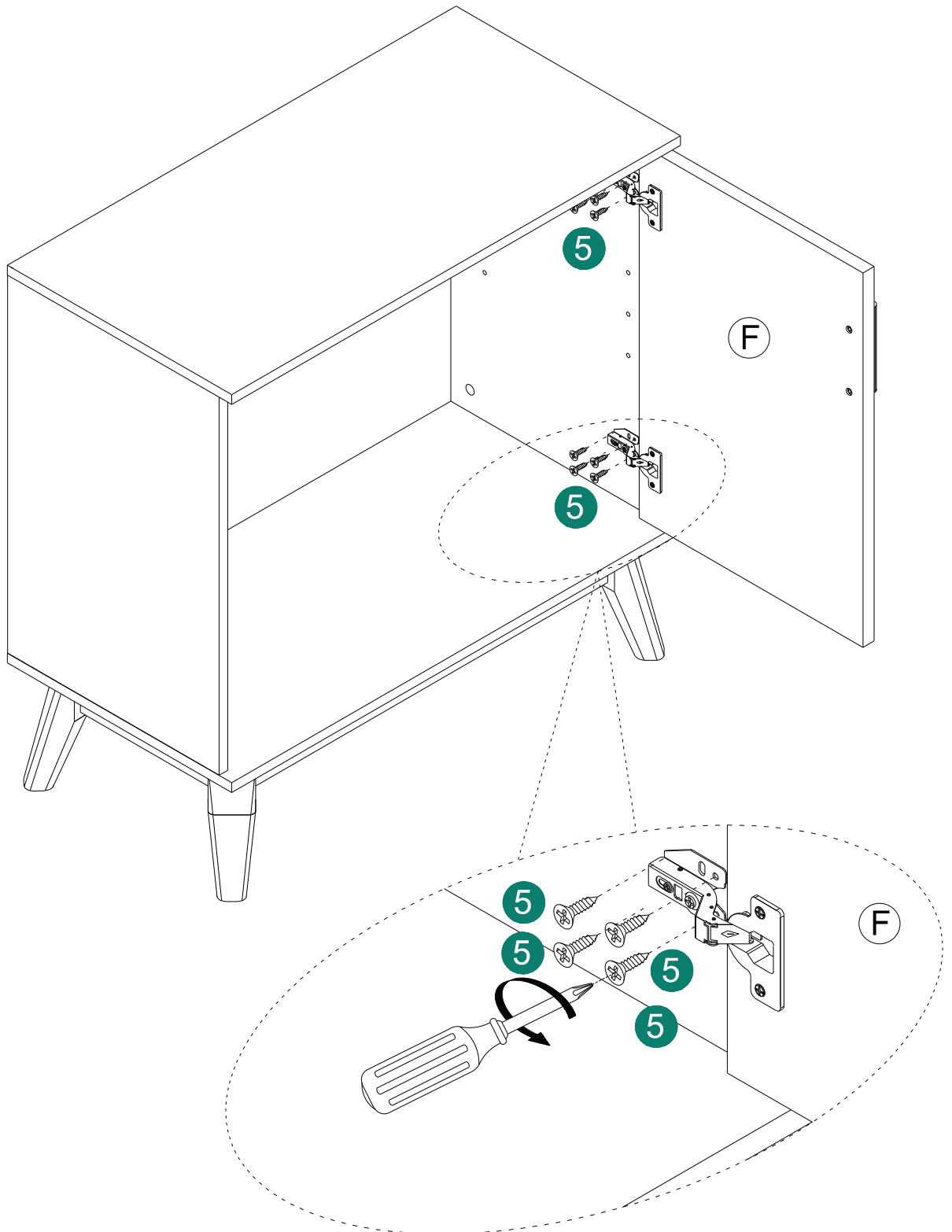

ASSEMBLY INSTRUCTIONS

6



5 8pcs

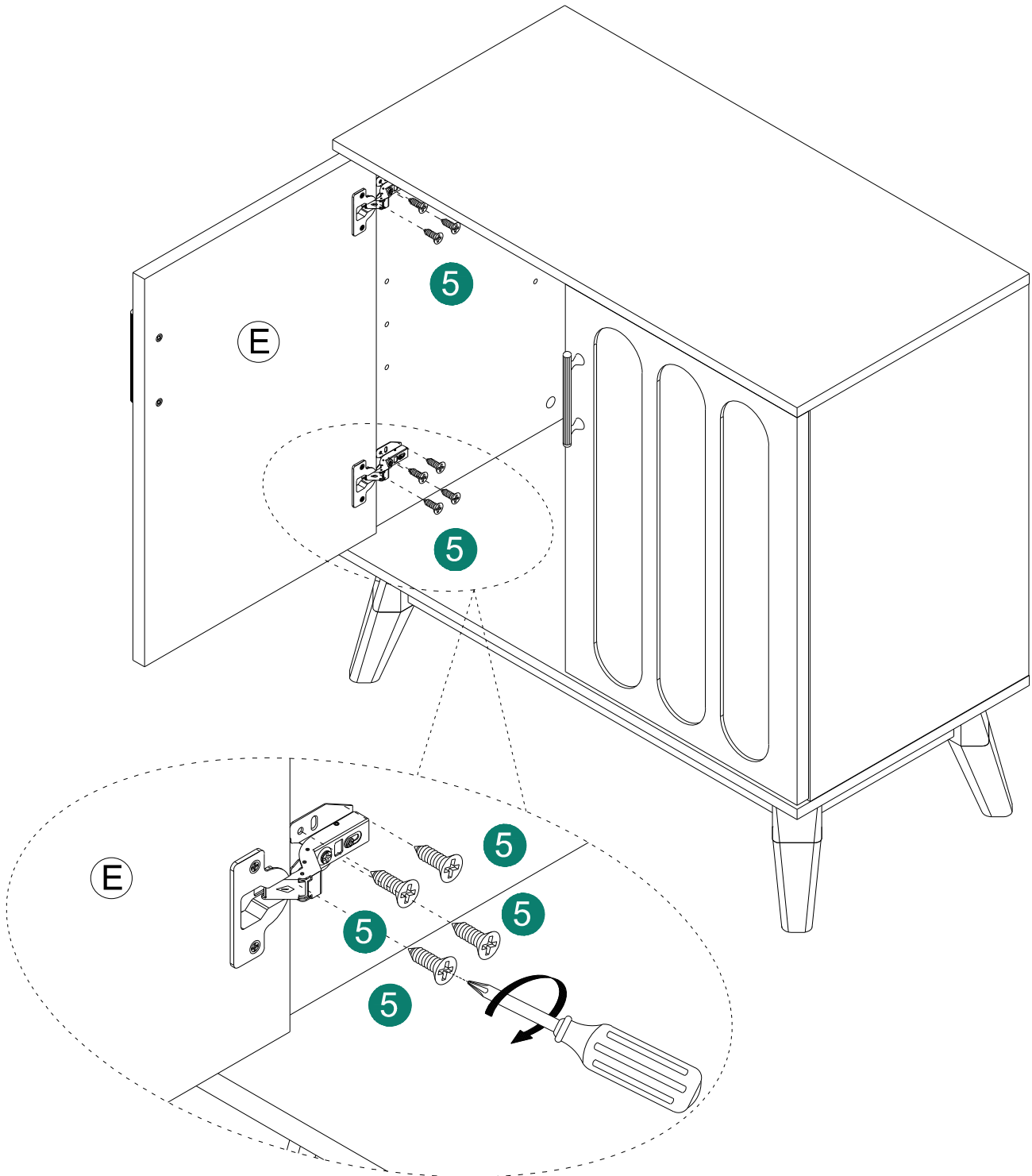

ASSEMBLY INSTRUCTIONS

7

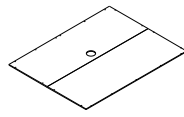

G 1pc



4 18pcs

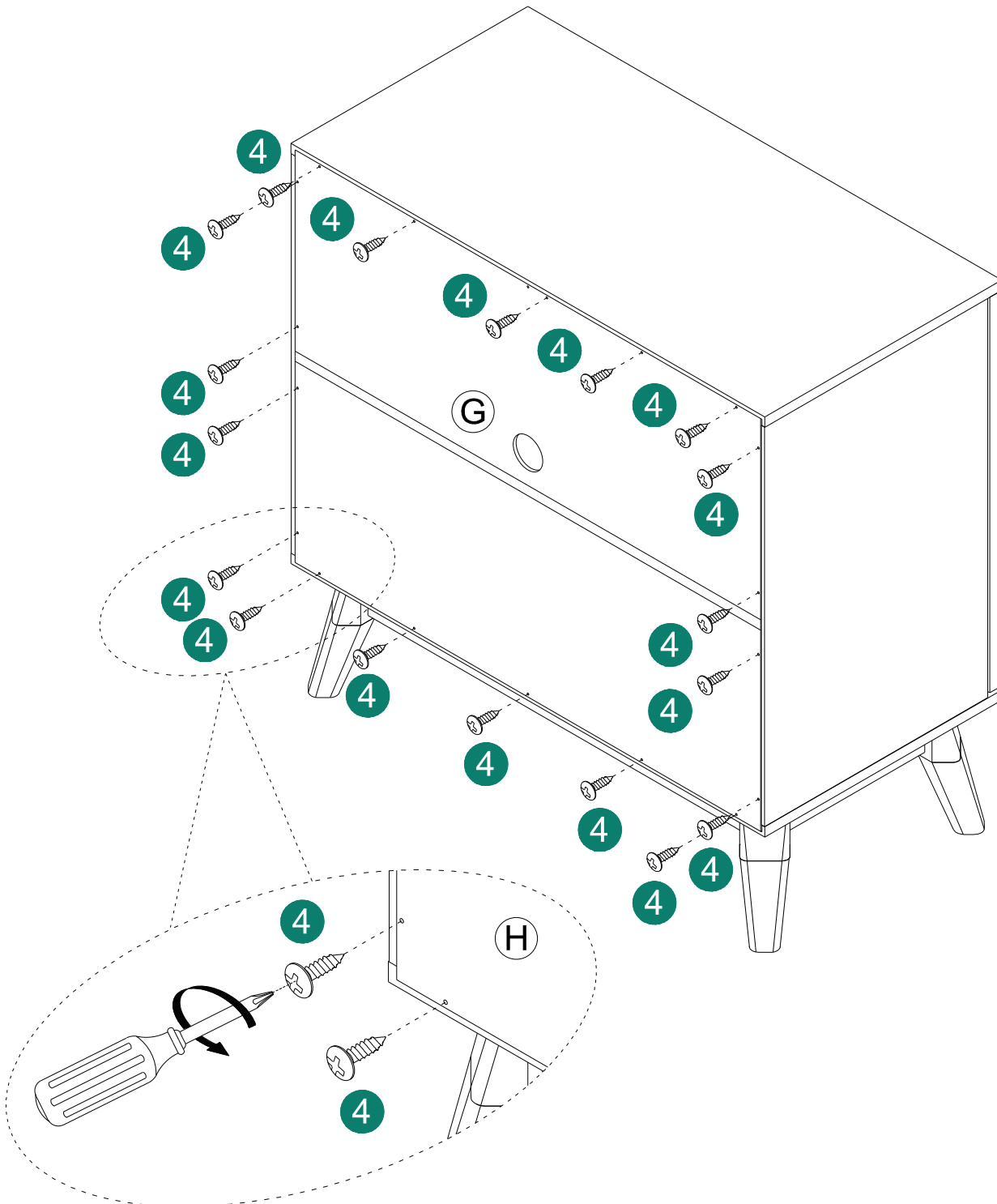

ASSEMBLY INSTRUCTIONS

8

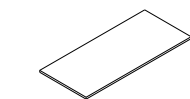

ⓓ 1pc



13 4pcs

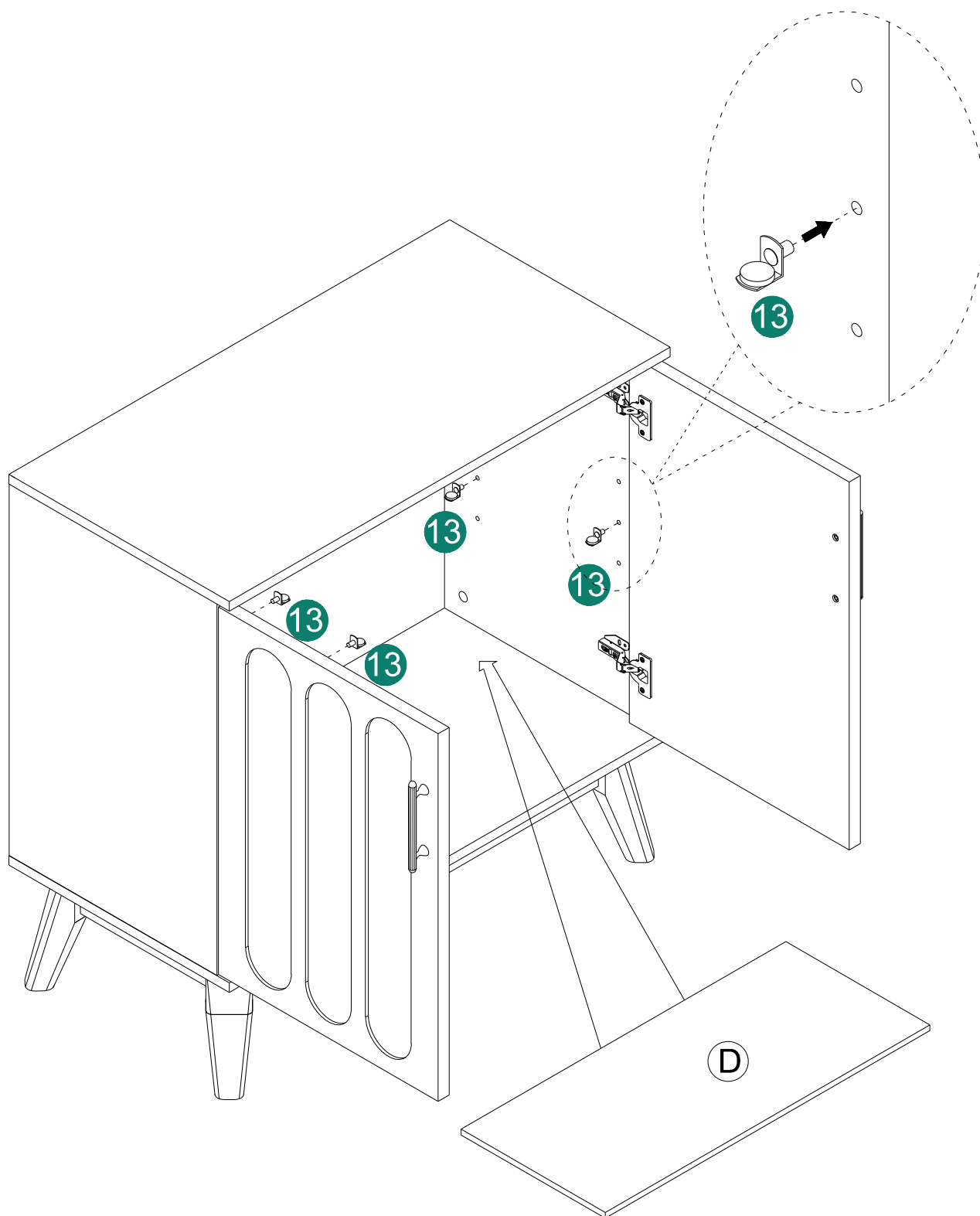

ASSEMBLY INSTRUCTIONS

9

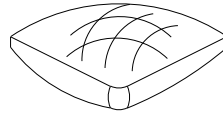

14 1set

A

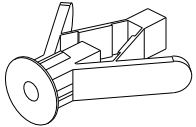

1pcs

B

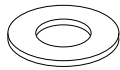

2pcs

C

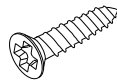

Ø8*3/4"

1pcs

D

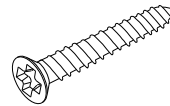

Ø8*1-1/2"

1pcs

E

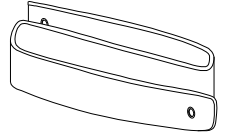

1pcs

WALL

