

980800

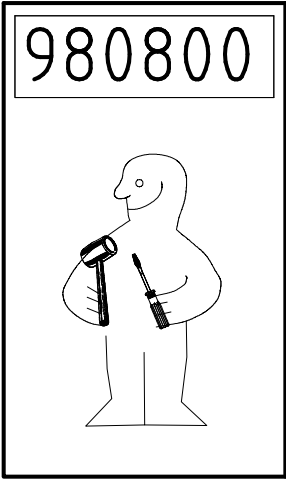

1.

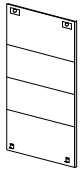

980890

2.

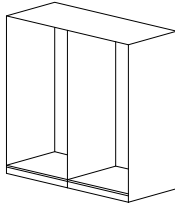

980863

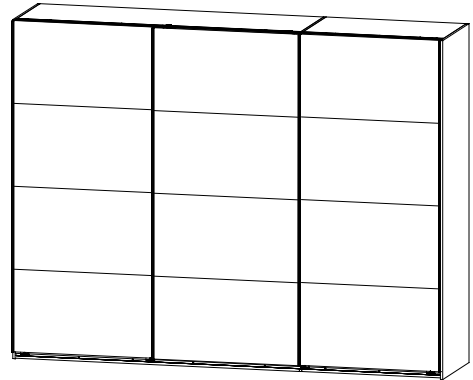

NSP 270 4Hg-3trg

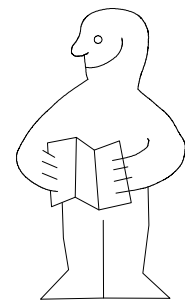
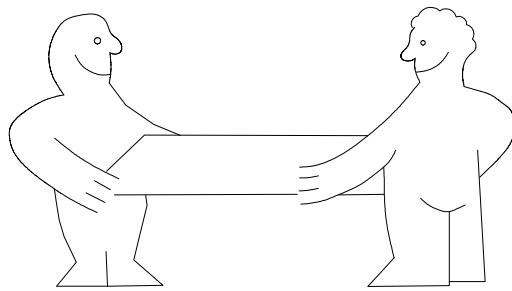
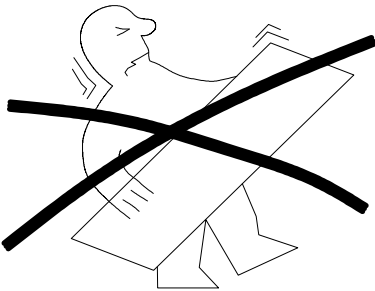

1-2-3-4... ○ ○

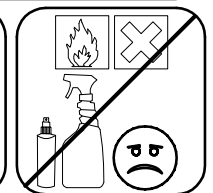
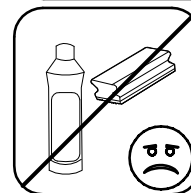
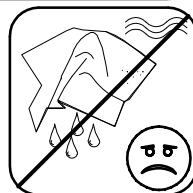
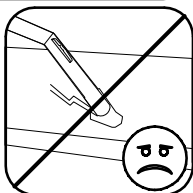
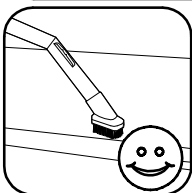
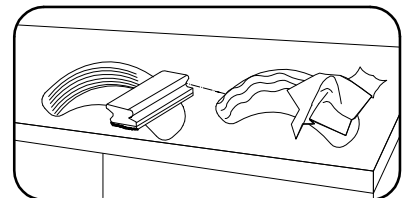
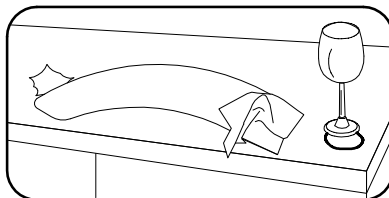
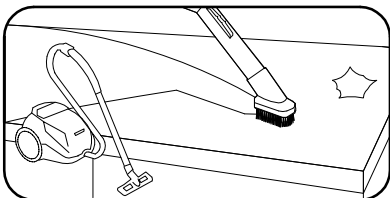
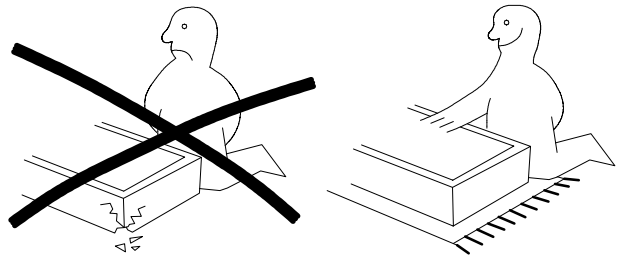
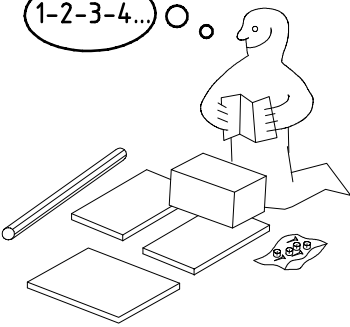

980800



10.01.22 / -

01 22

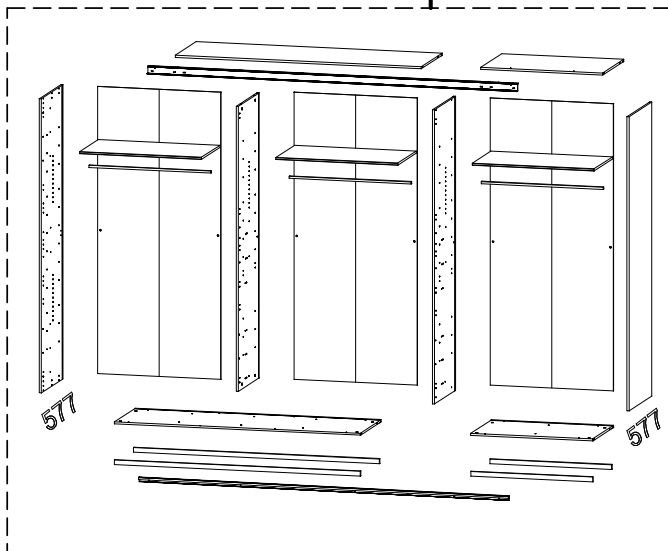
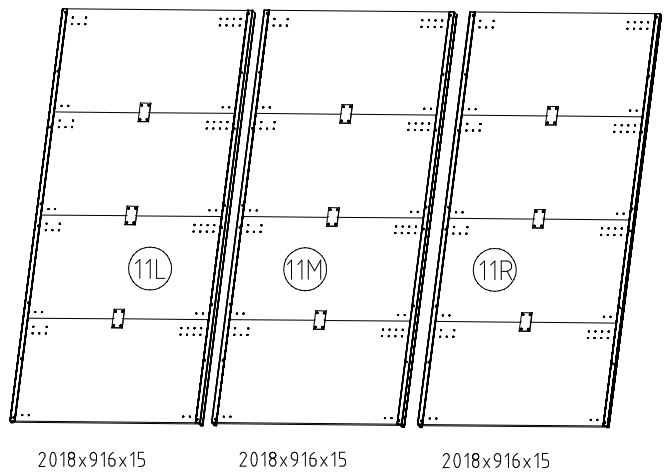
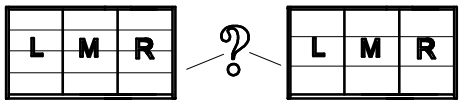
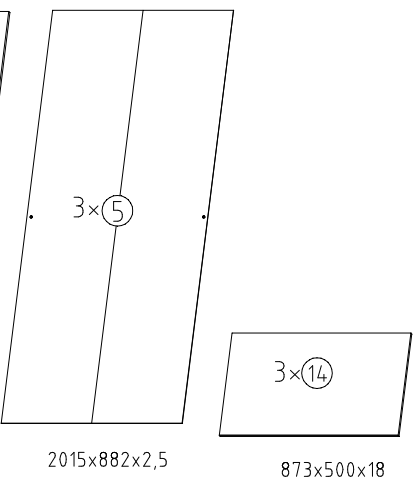
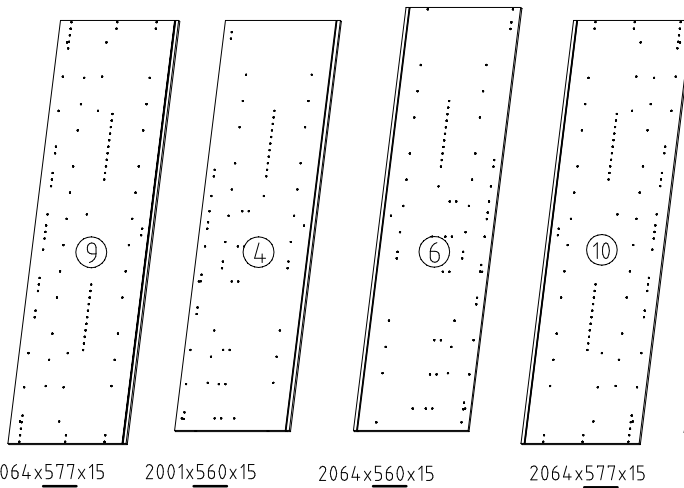
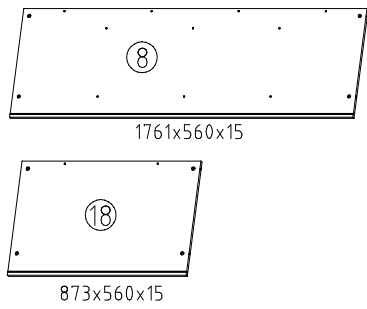
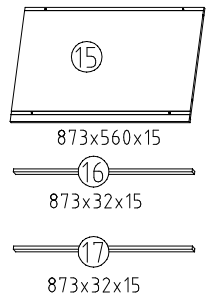
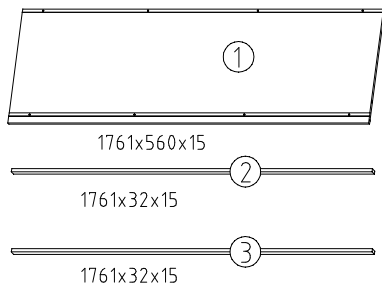
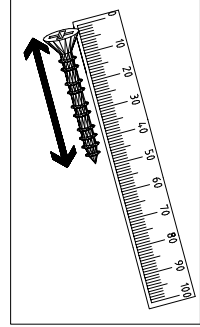
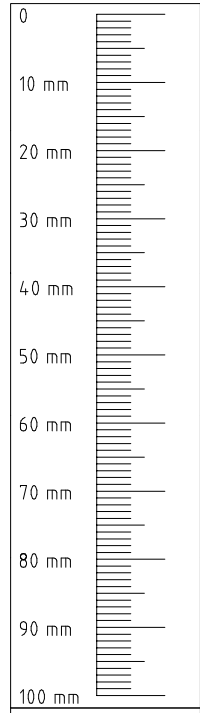
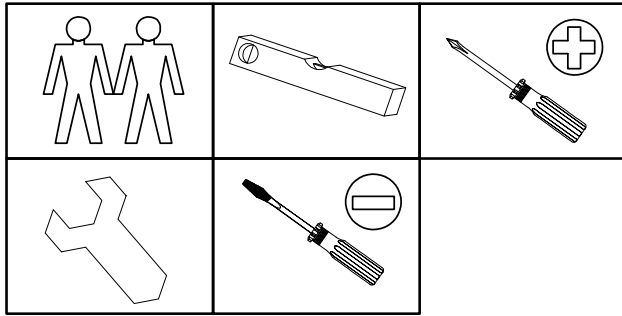
1/20

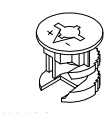
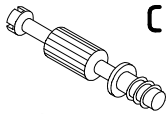
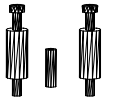

 111 102	A 20x
 111 103	C 12x
 111 174	F3 4x

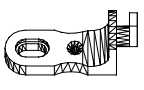
 121 370	3,5 x 15 mm G1 12x
 117 001	K1 6x
 111 174	J1 6x

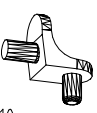
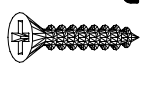
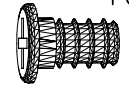
 111 610	L7 12x
 121 375	3,5 x 35 mm G14 16x
 121 181	M6 x 11 mm T6 6x

 112 402	870mm K20 3x
--	---------------------------

1x
FPN

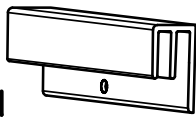



1316/1760
2204/2648/3092/3536

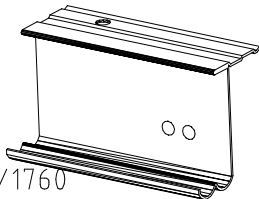



1x
LP

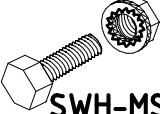

1316/1760
2204/2648/3092/3536

ST

 SWH-ST	2x
 SWH-MS	2x
M4 x 13 mm  121 xxx	GH13 7x
M4 x 10 mm  121 xxx	G43 7x

 SWH-SKL	L 1x
 SWH-SKR	R 1x
 4 X 13mm 121 122	SP13
 3,5 x 22 mm 121 004	G24 10x

 SW-STM	1x
---	----

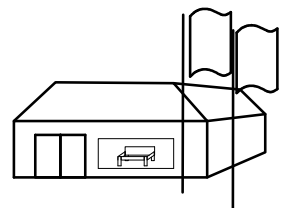
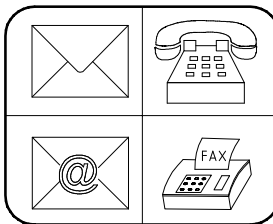
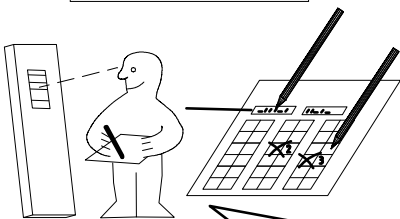
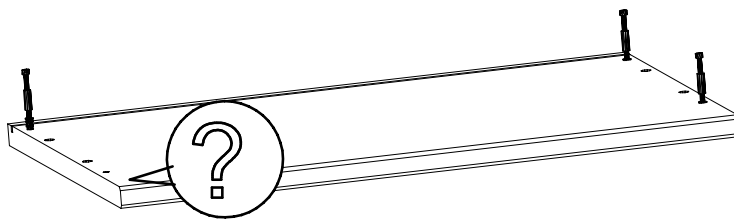
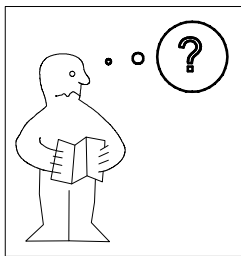

Auftrag/Order-No
No. de Commande

Kunde/Customer
Client



980863

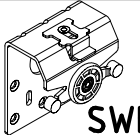
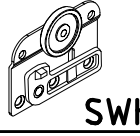
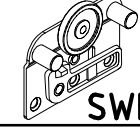

11.12.13 / 20.11.17

11 17

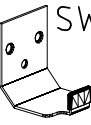
3/12

 SWH1	2x
 SWH2	2x
 SWH3	2x

SWH-D 	2x
SWH 6 	2x
SWH 7 	4x

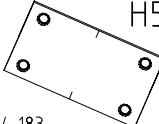
SP13 4 X 13mm 	90x
121 122 6,3 x 10,5 mm T2 	34x
111 030 H5 	6x

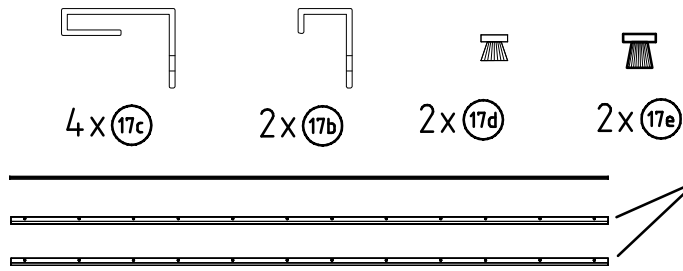
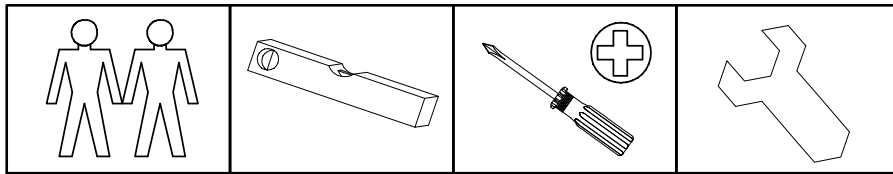
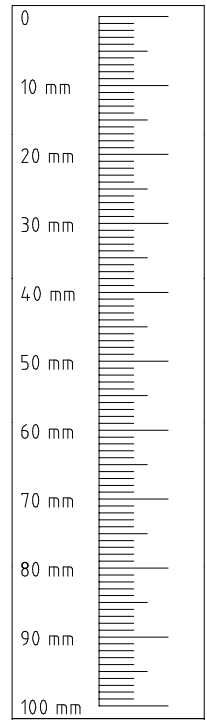

- (17d)
- (17c)
- (17b)

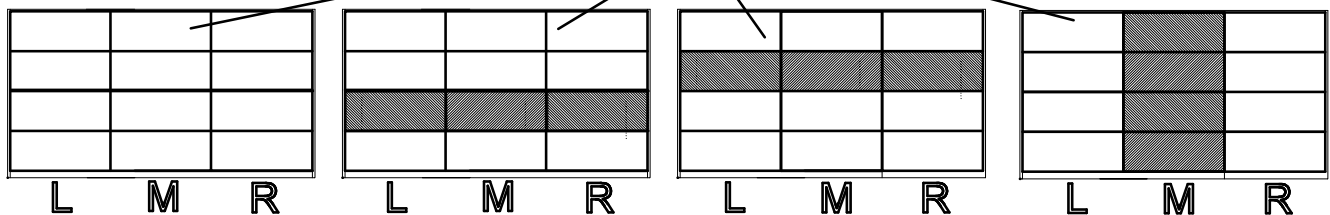
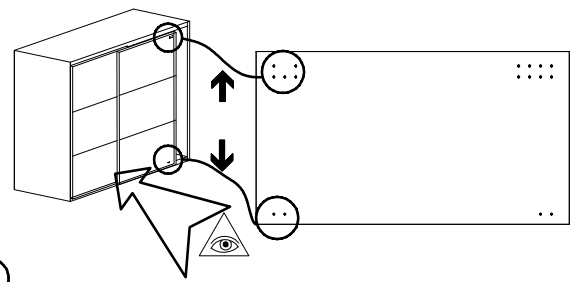
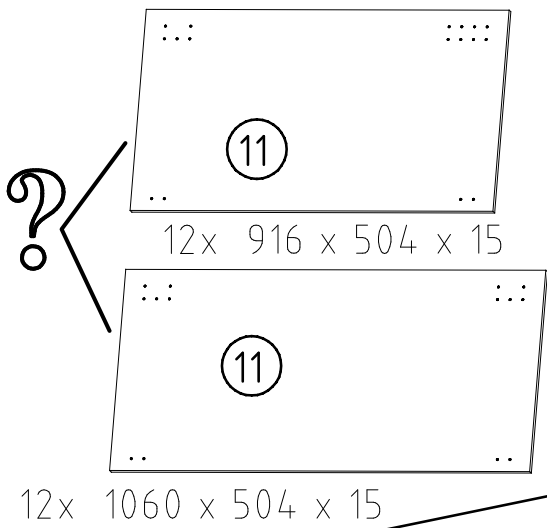
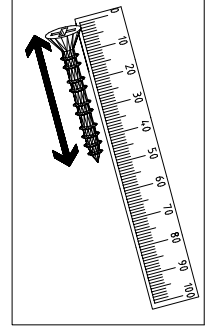
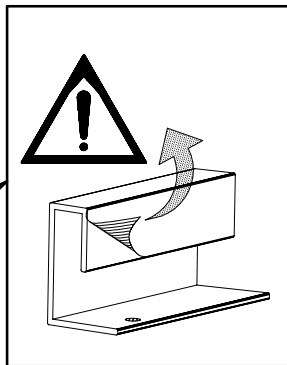

1

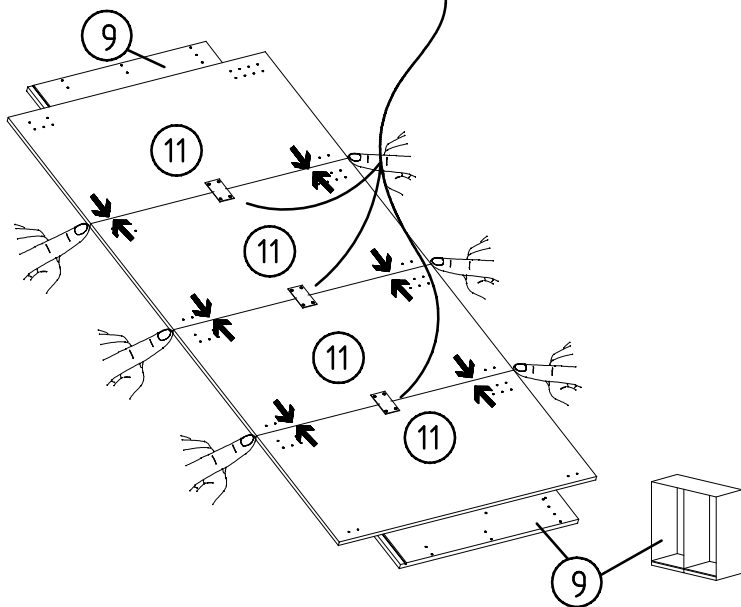
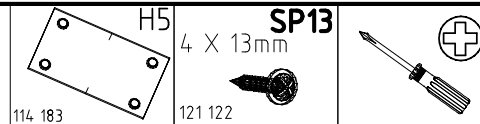
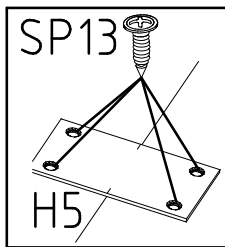
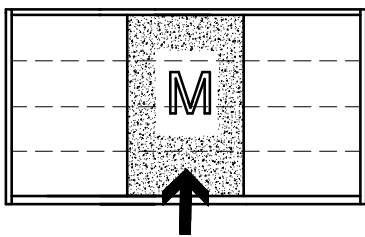

2

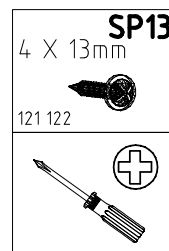
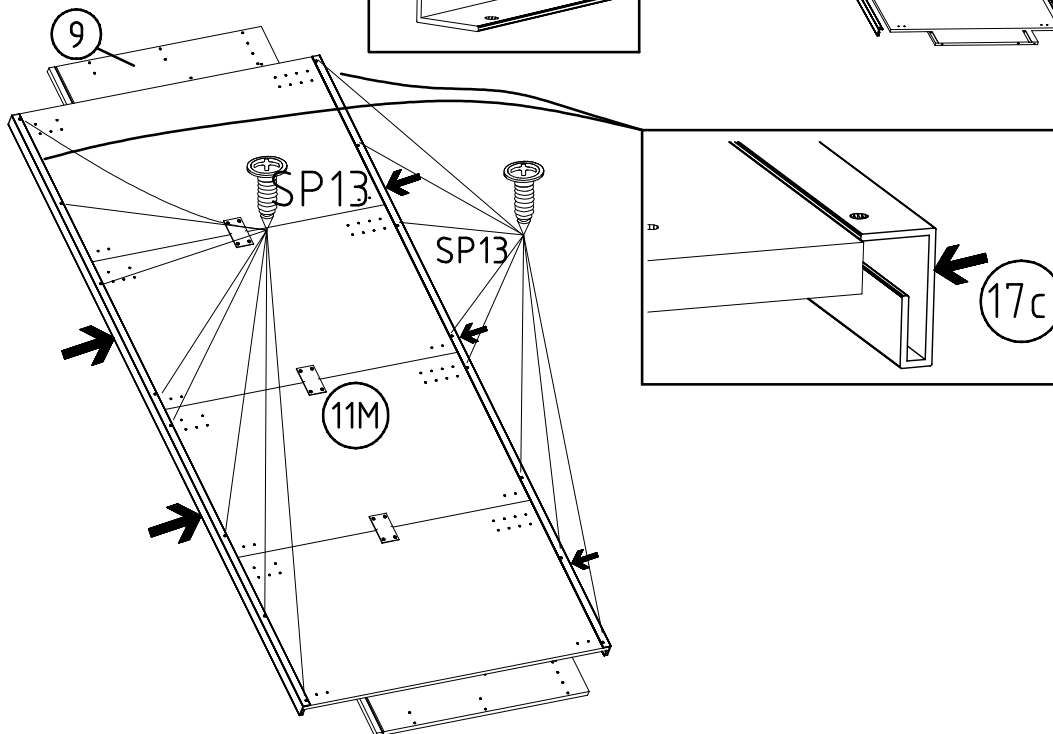
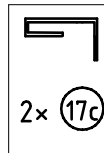
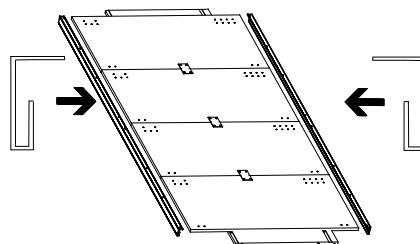
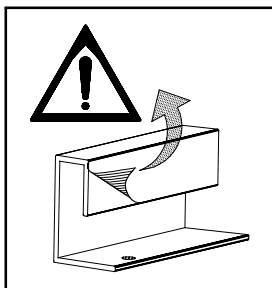

3

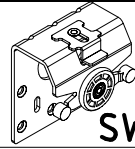

SWH1

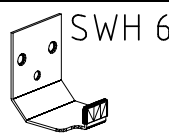

SWH6

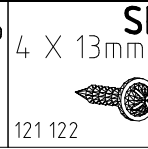

SP13

4 X 13mm

121 122

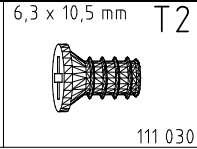

6,3 x 10,5 mm

T2

111 030

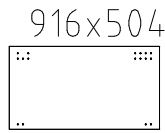
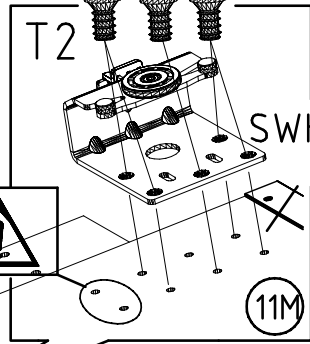
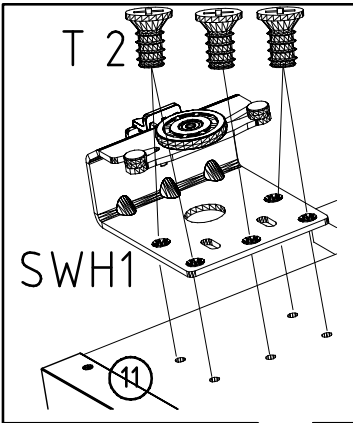
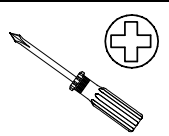

916x504



11M

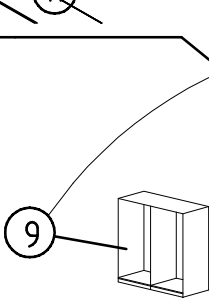

9

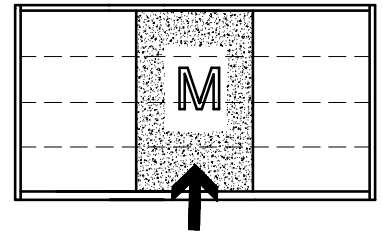

M

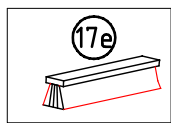
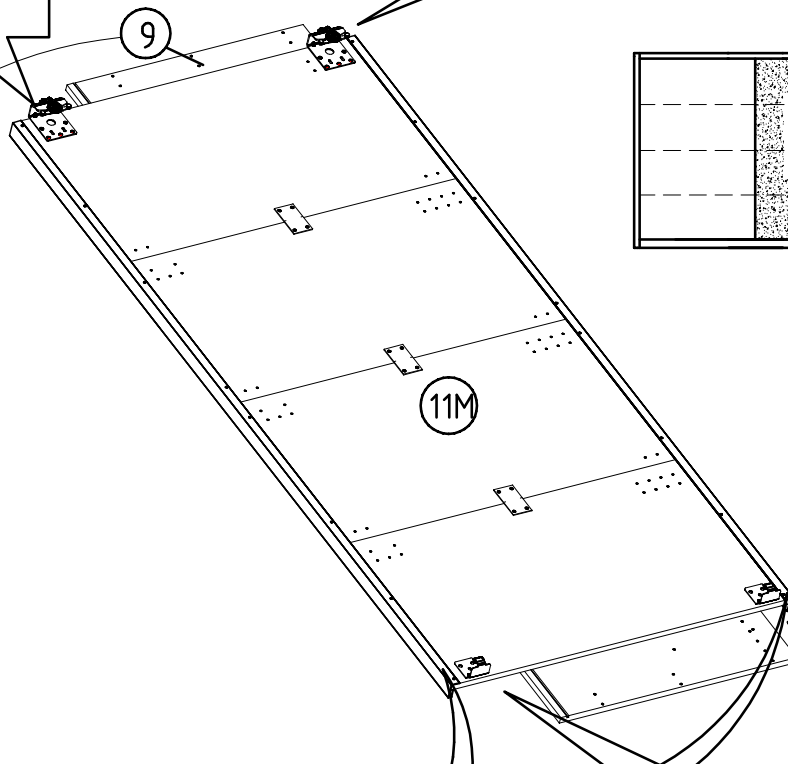

17e

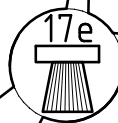

17e

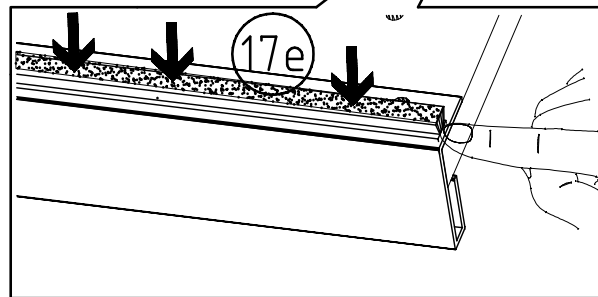
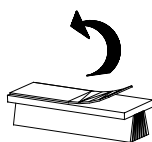

17e

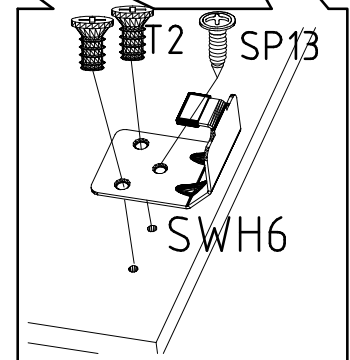

SWH6

4

H5
4 X 13mm
SP13
114 183
121 122

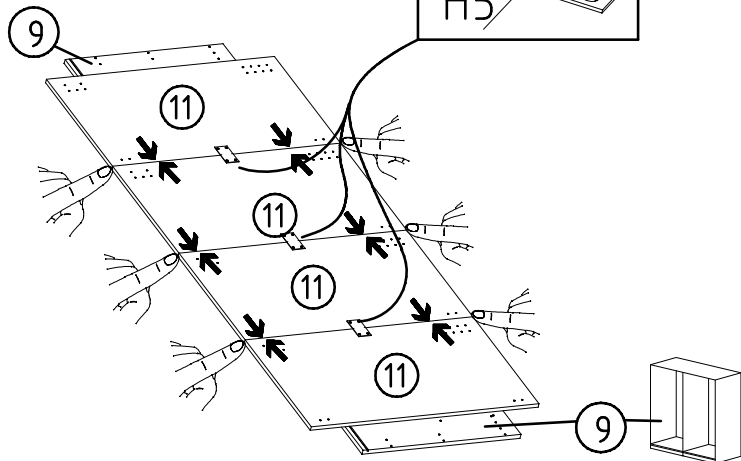
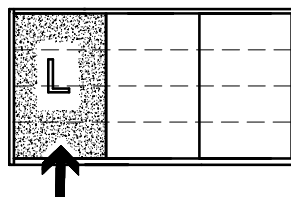
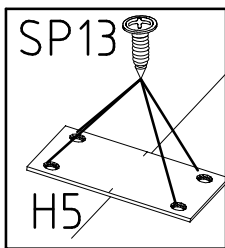
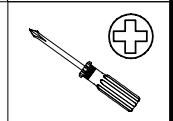

5

4 X 13mm
SP13
121 122

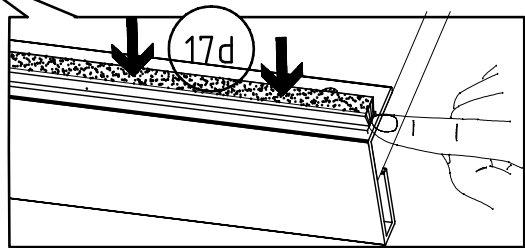
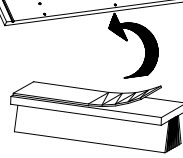
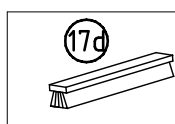
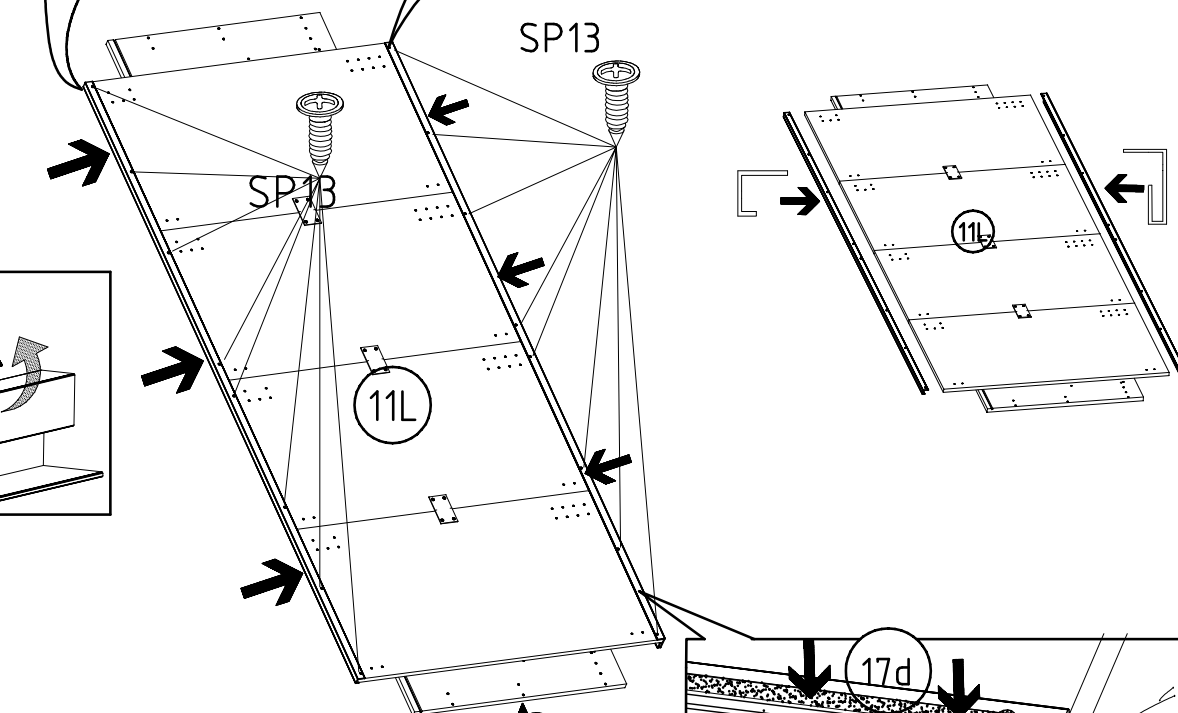
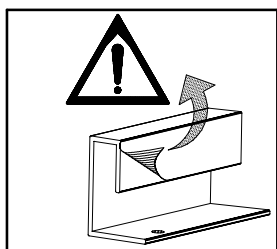
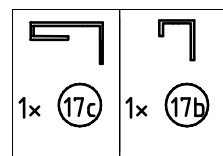
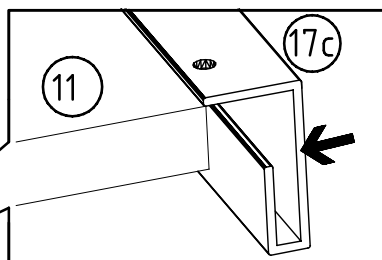
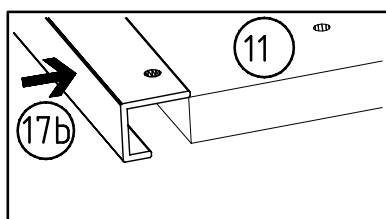

6

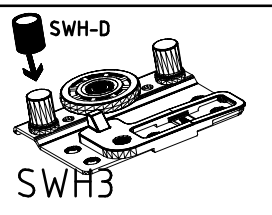
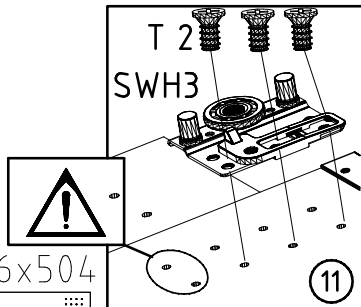
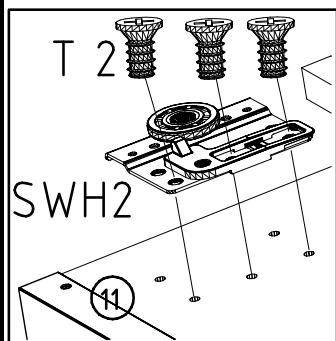

916x504

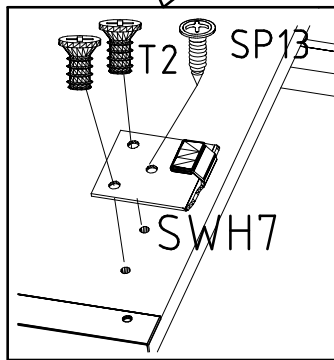
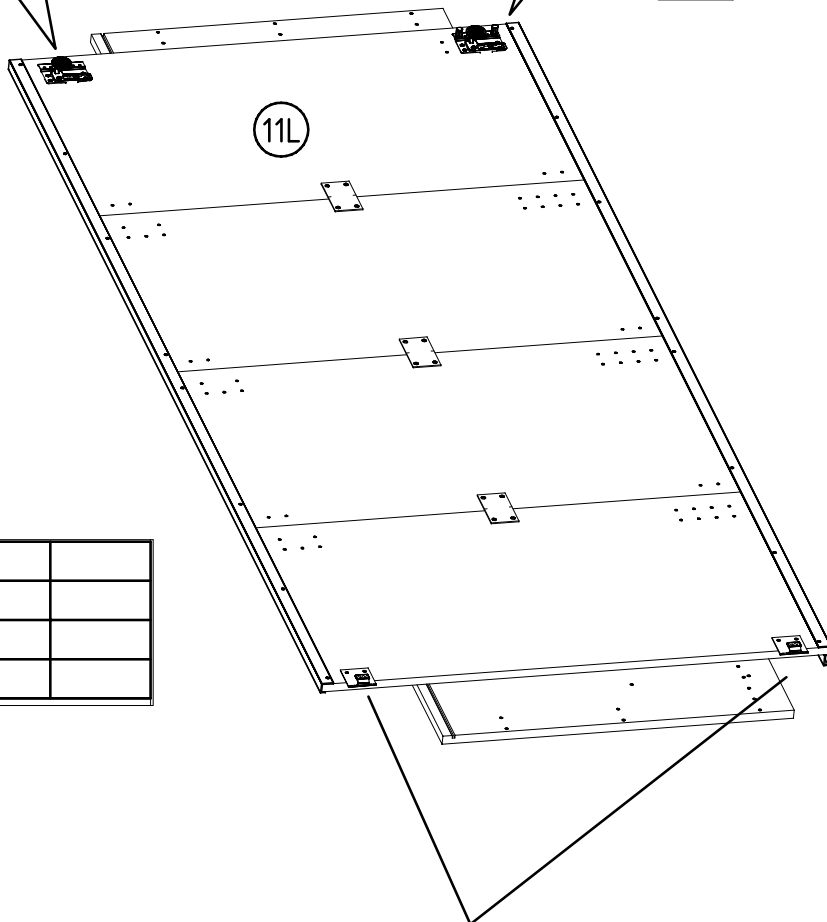

SWH2	SWH3
SWH-D	SWH7
6,3 x 10,5 mm T2	SP13
	4 X 13mm
111 030	
	121 122

7

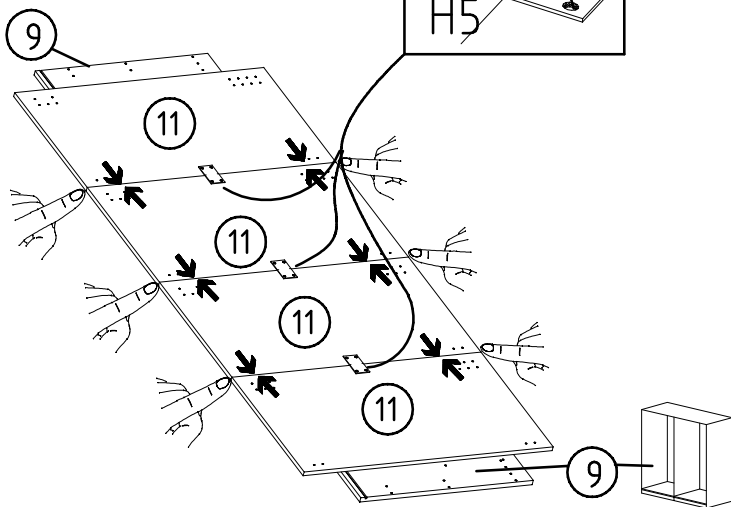
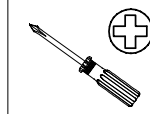
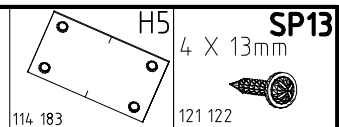
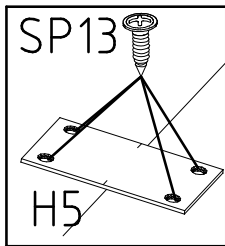
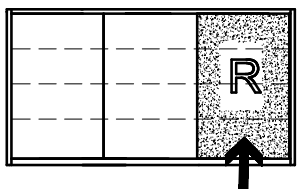

8

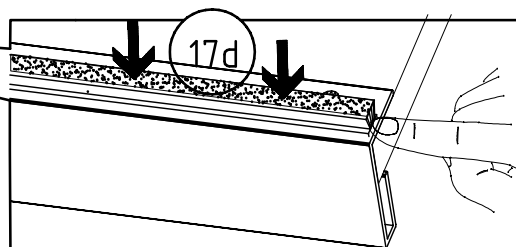
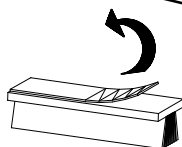
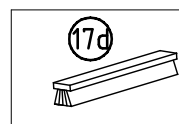
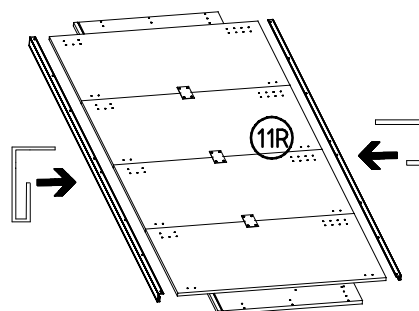
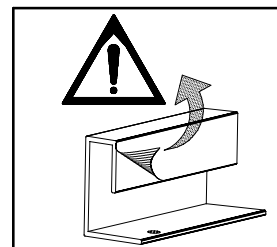
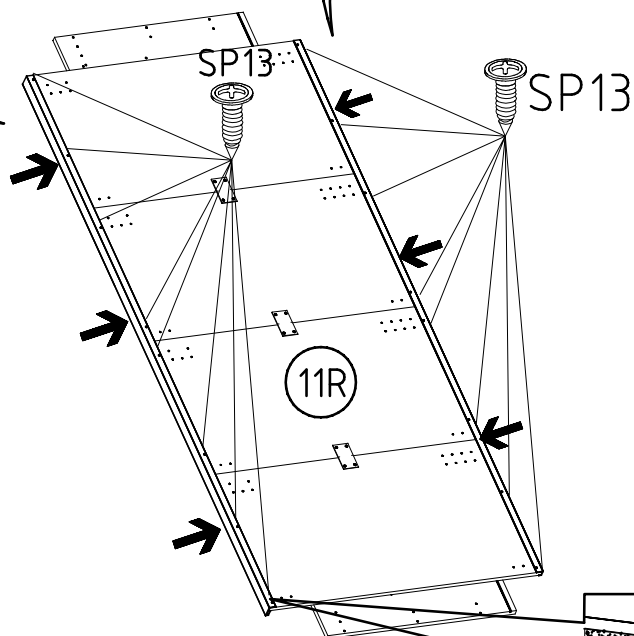
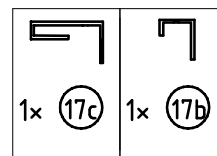
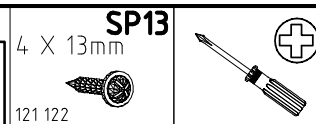
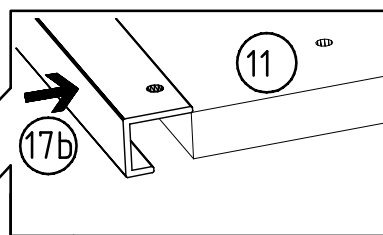
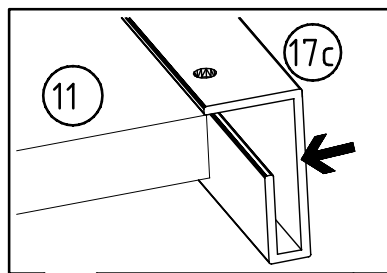

9

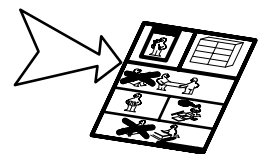
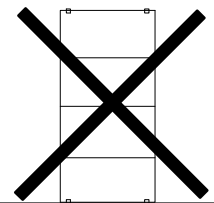
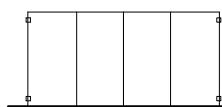
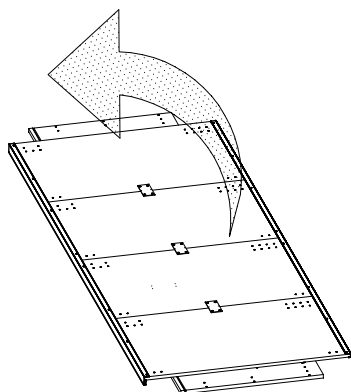
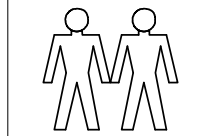
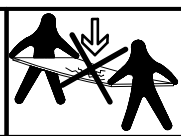
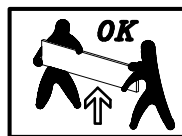
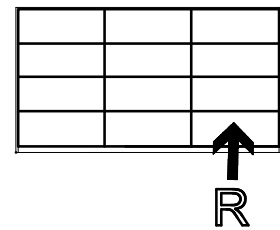
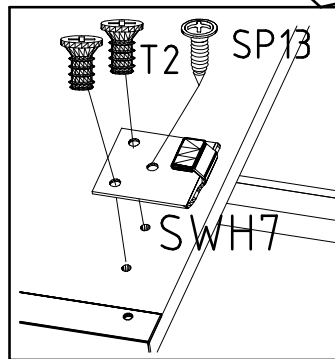
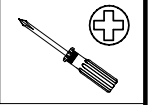
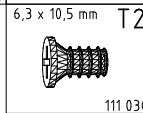
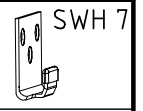
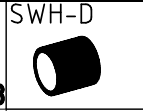
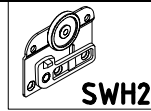
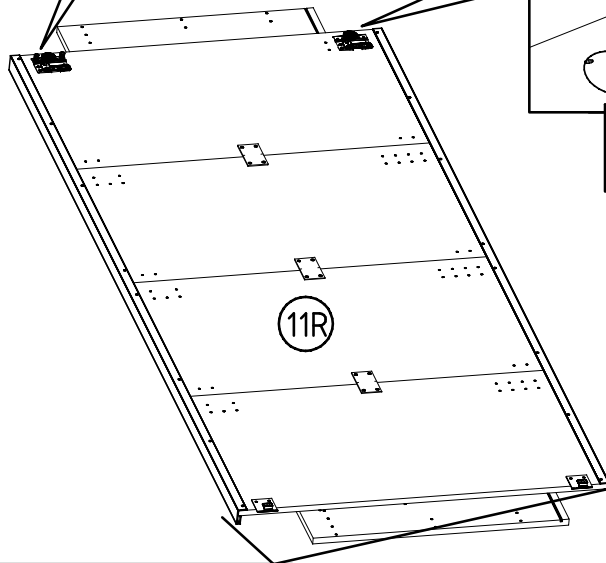
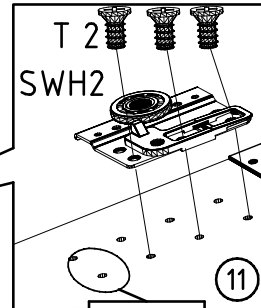
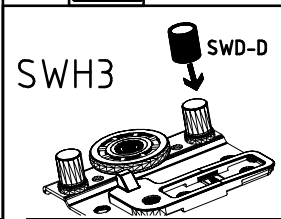
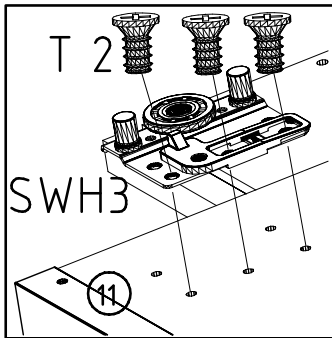

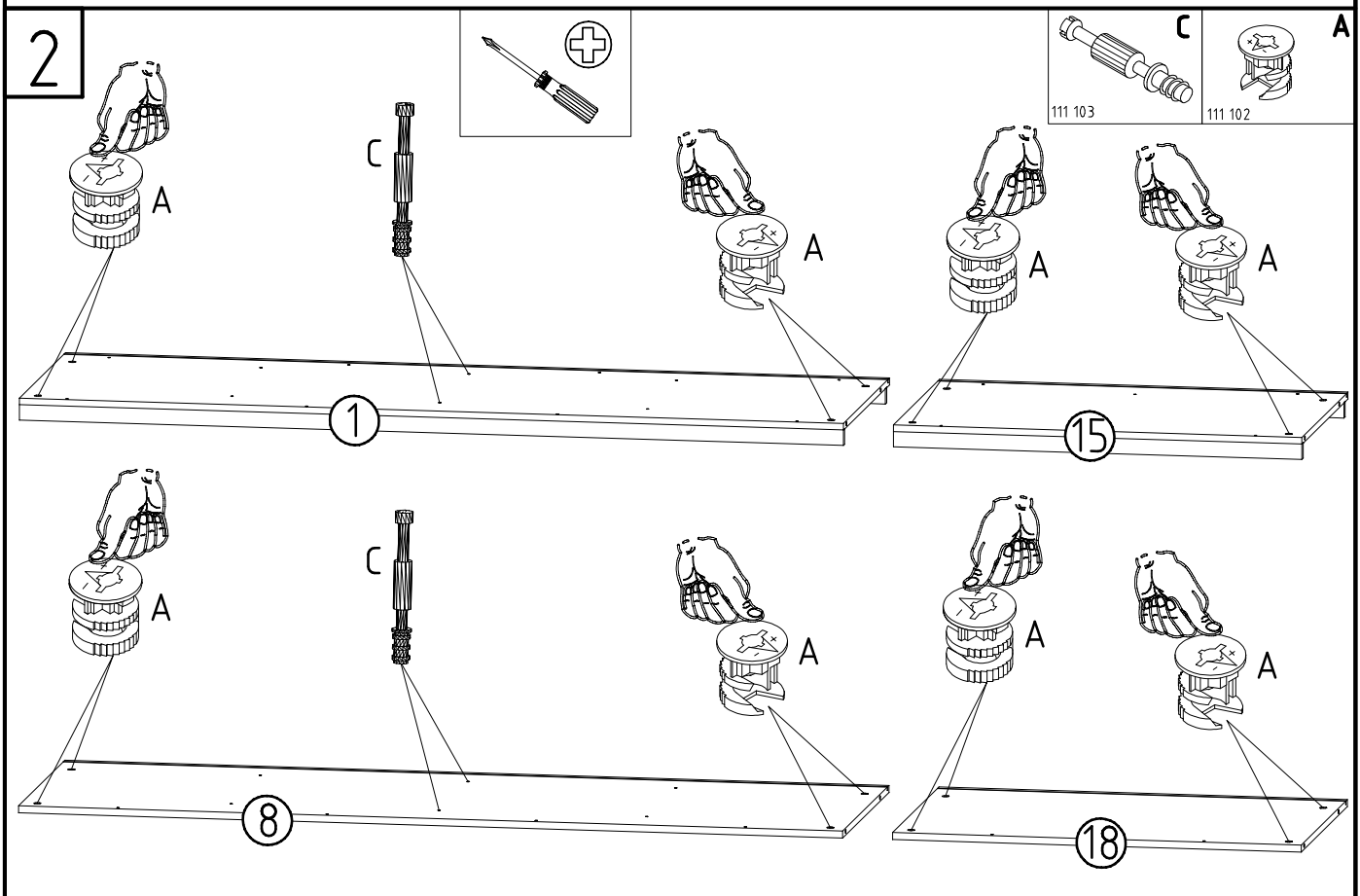
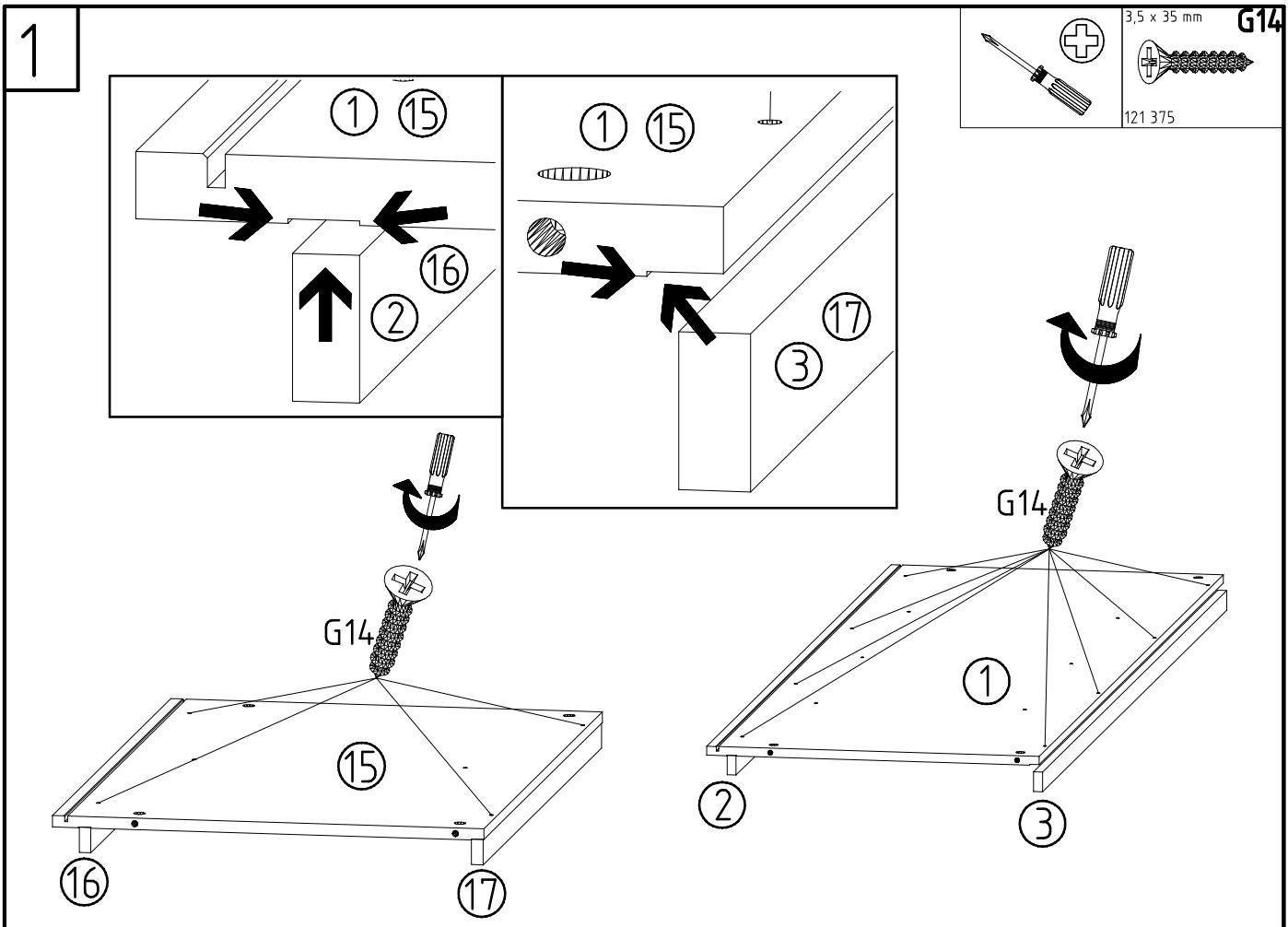

3

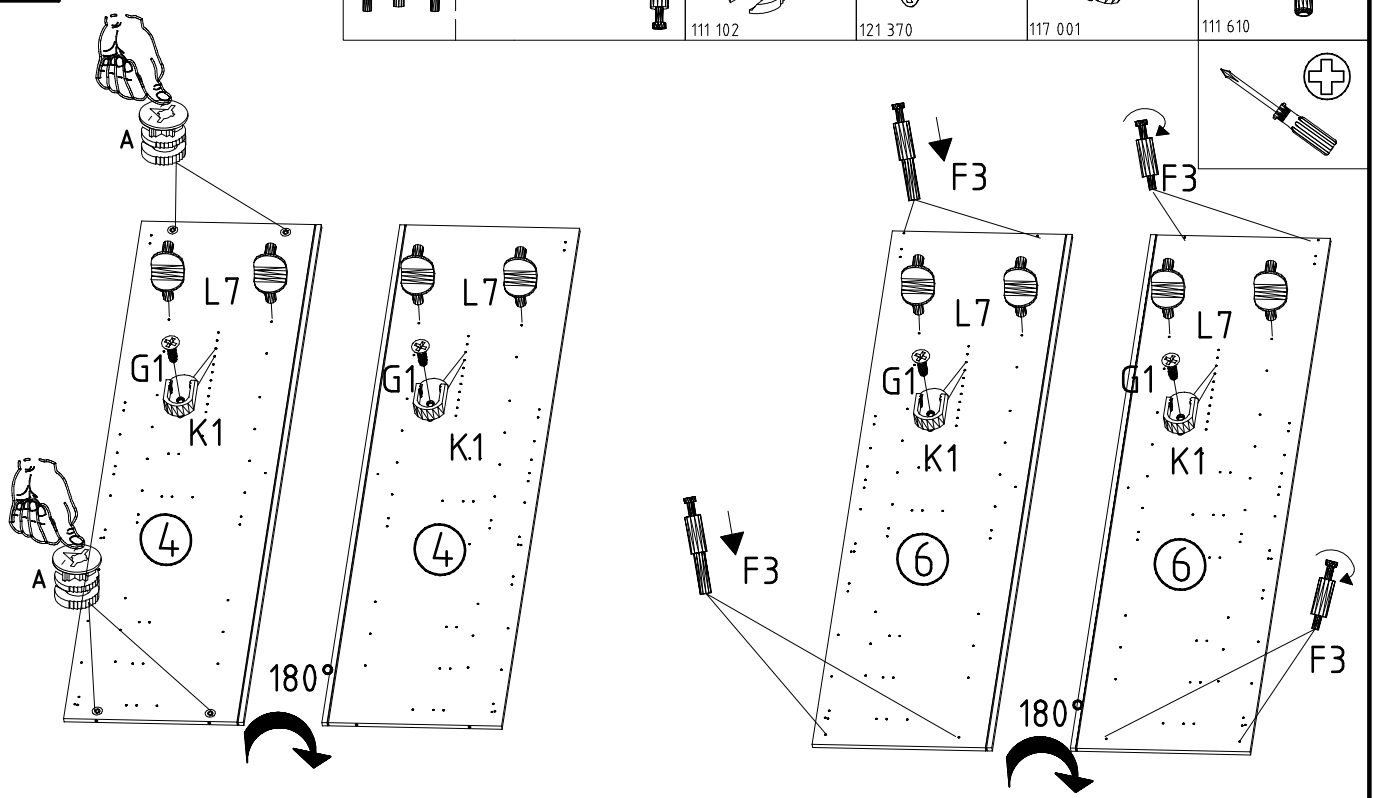
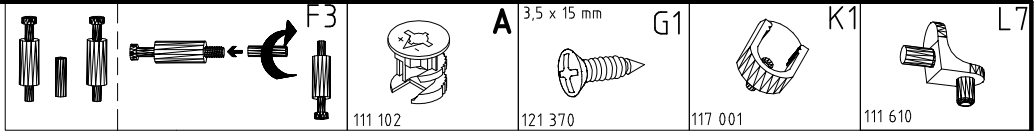

4

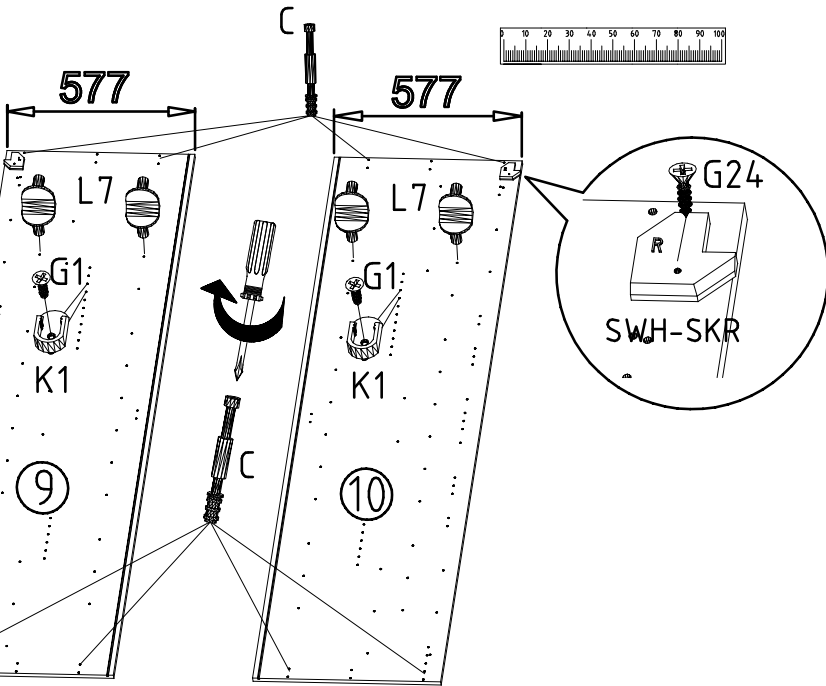
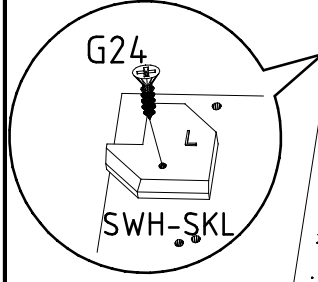
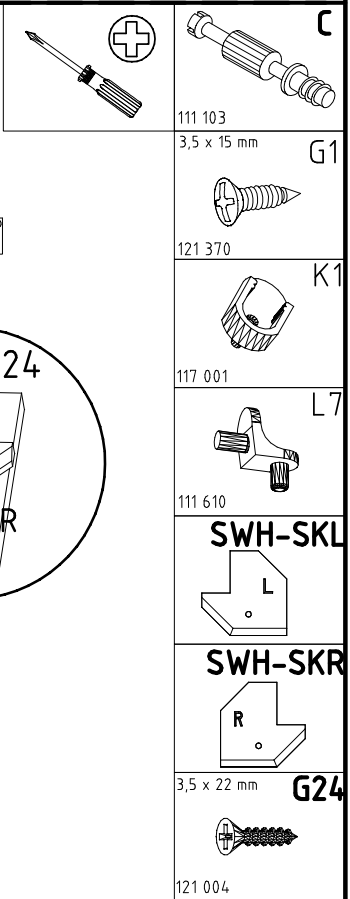
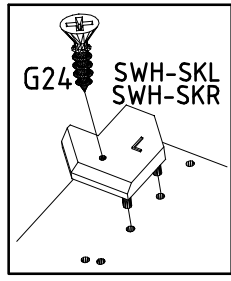

5

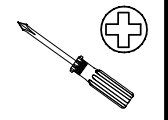
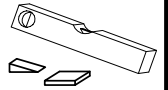
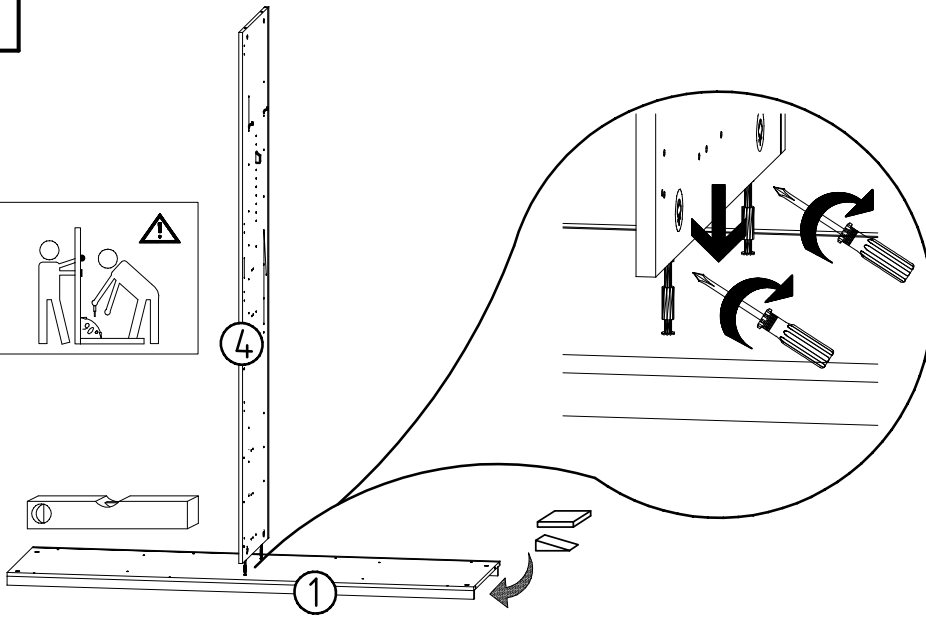
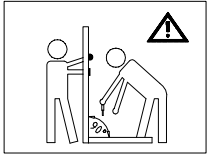

6

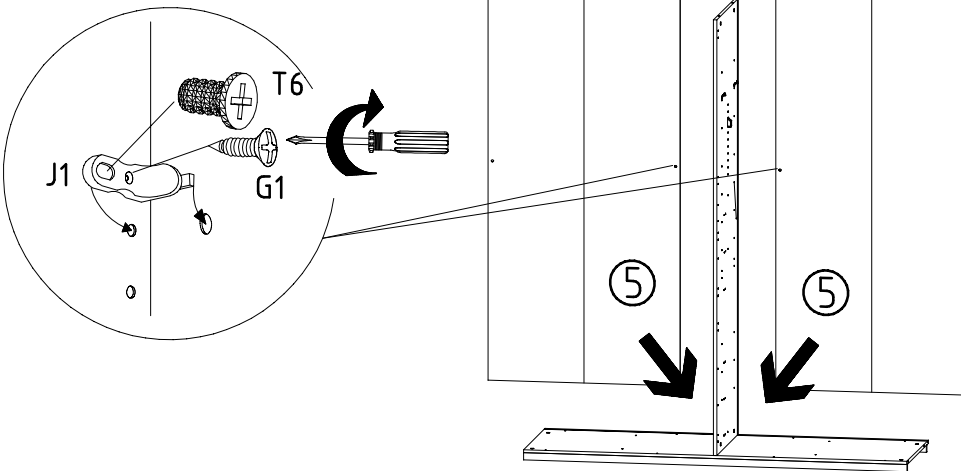

3,5 x 15 mm G1



121 370

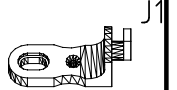

111 174

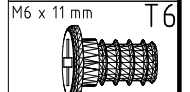

M6 x 11 mm T6

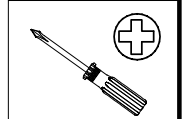

7

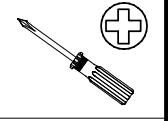
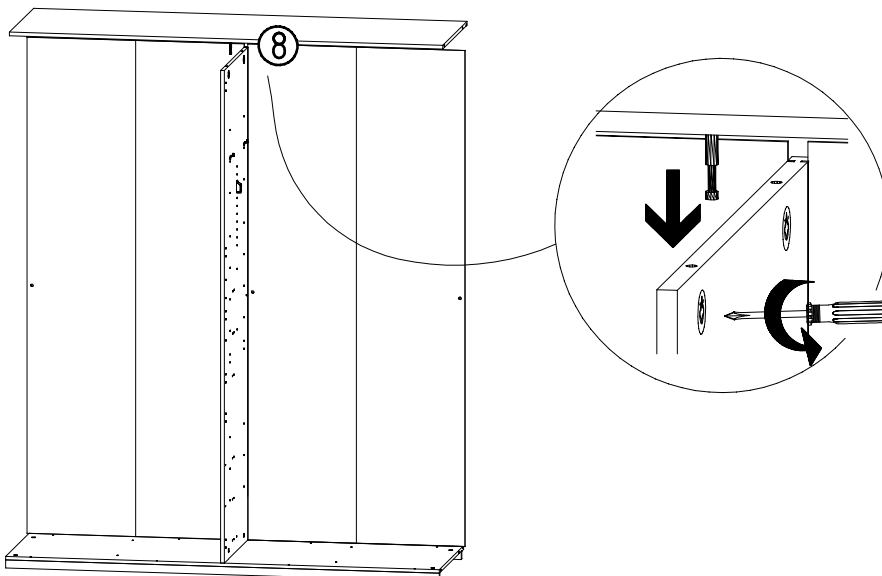

8

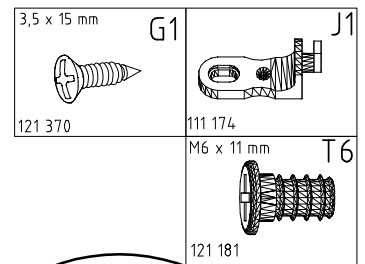
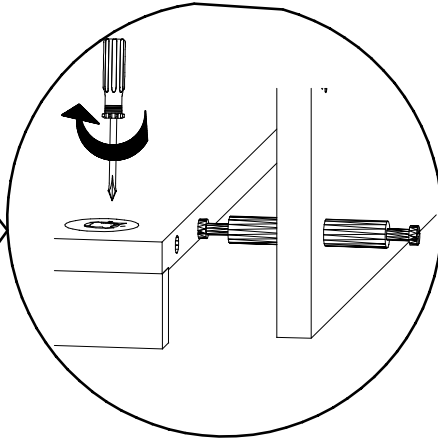
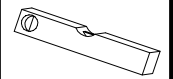
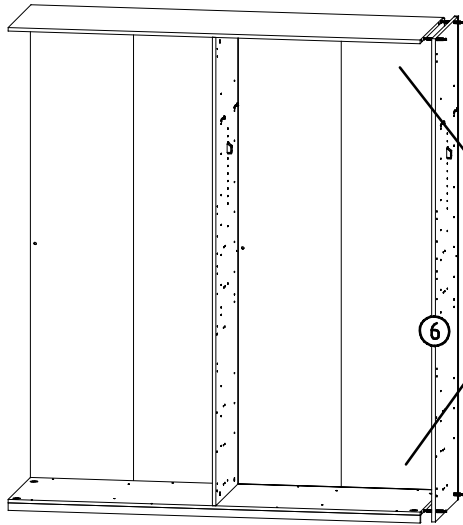

9

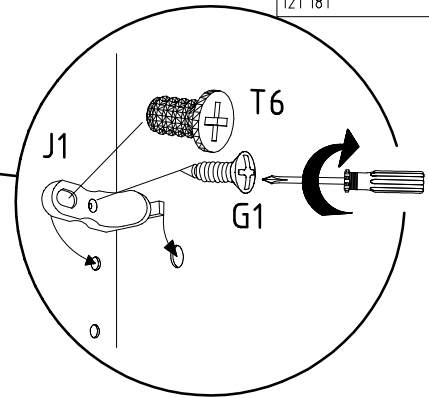
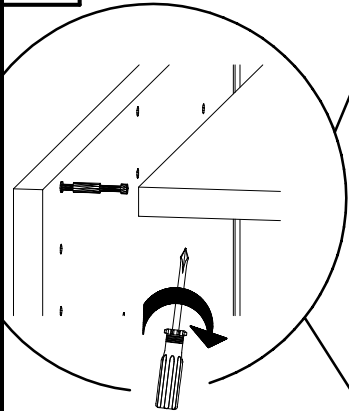
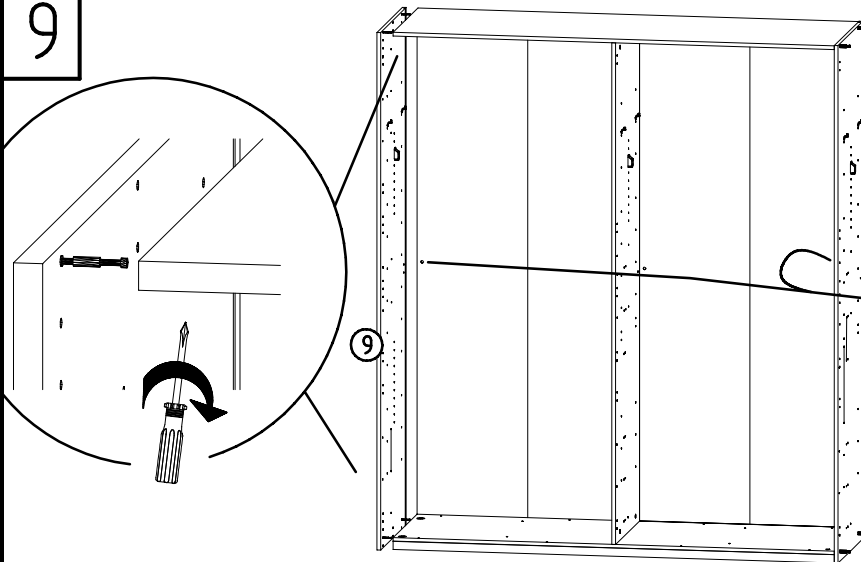

10

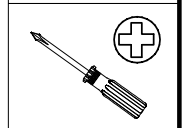
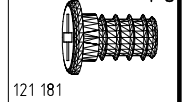
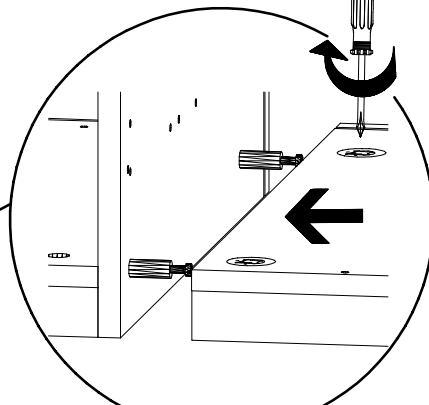
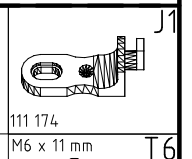
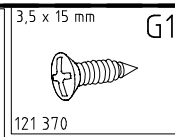
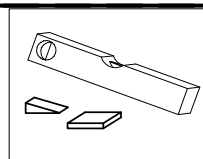
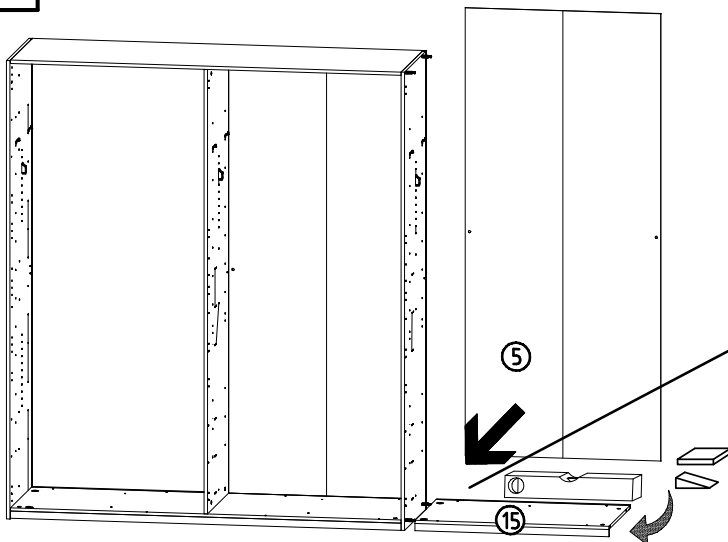

980863

11.12.13 / 20.11.17

11 17

7/12

11

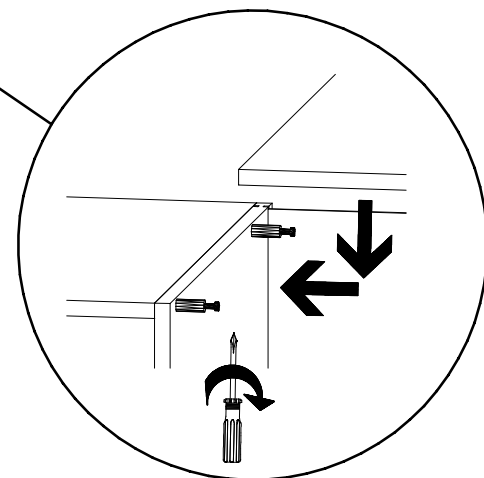
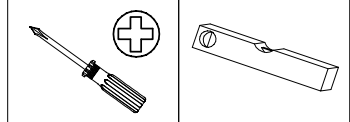
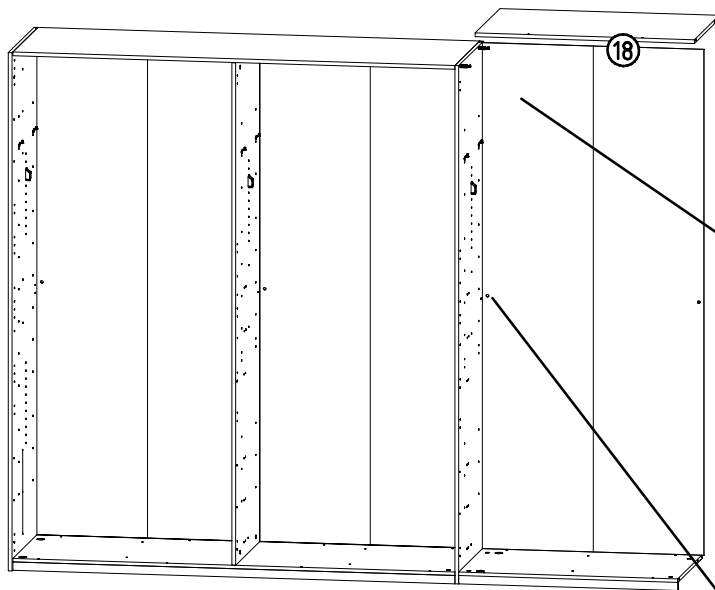

12

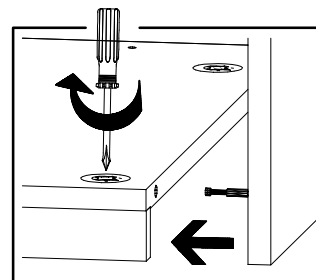
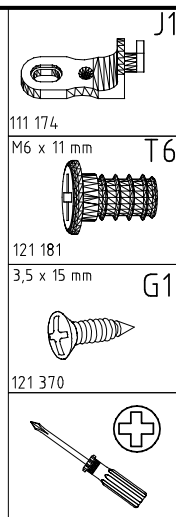
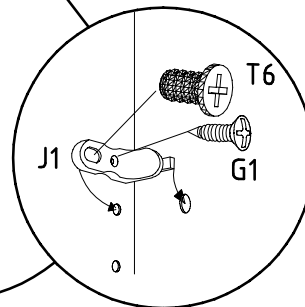
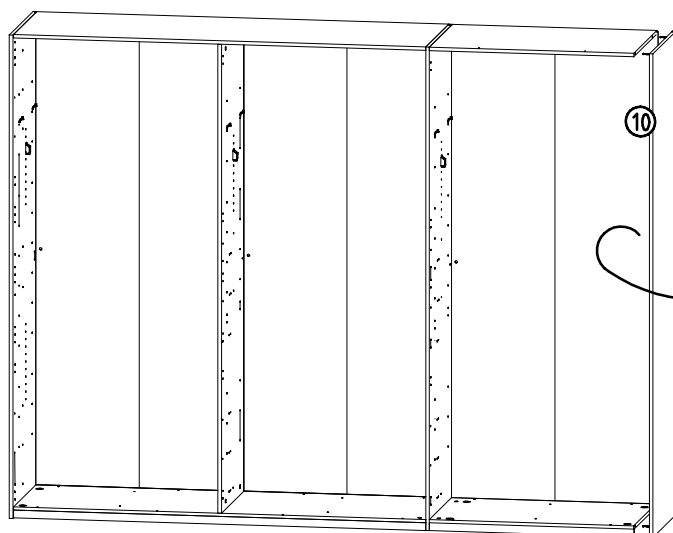

13

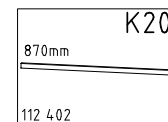
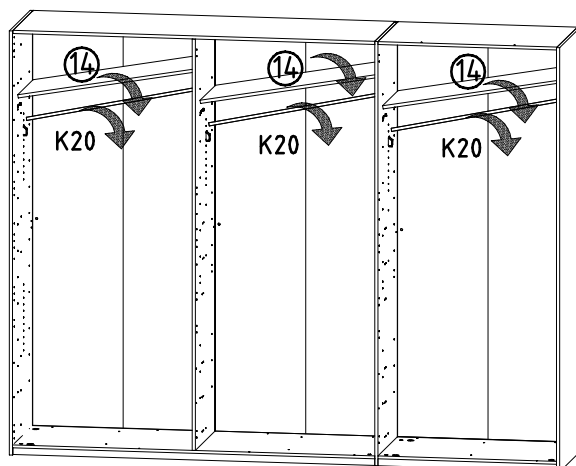

14

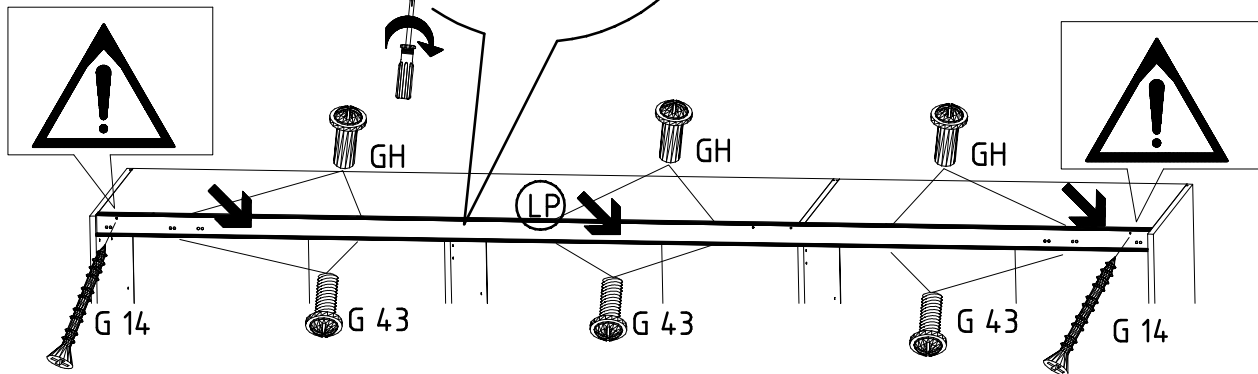
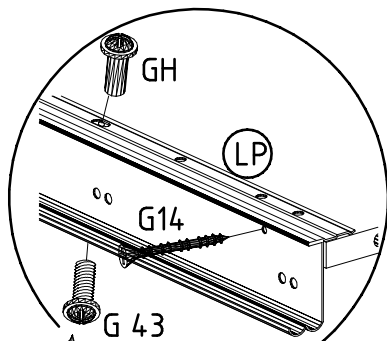
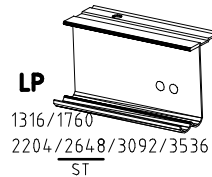
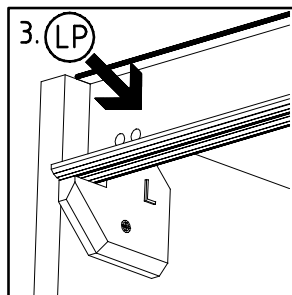
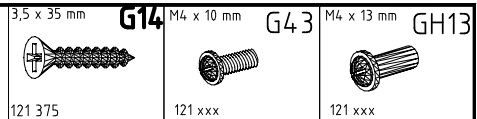
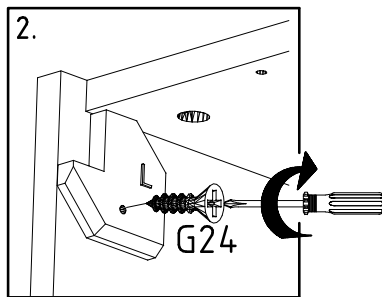
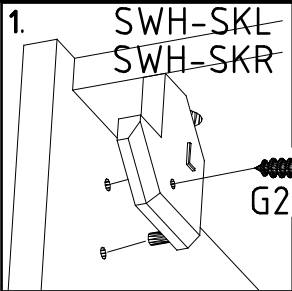

15

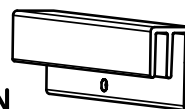
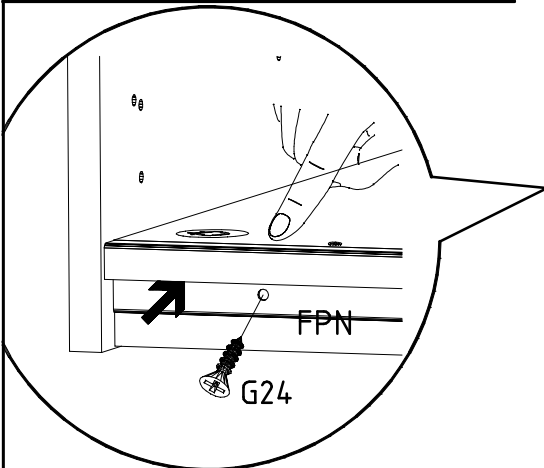
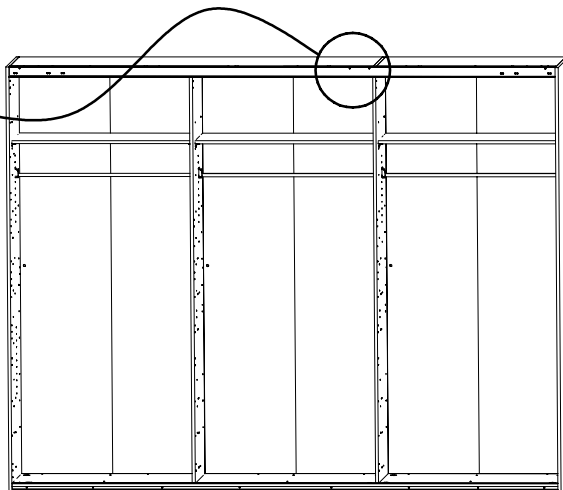
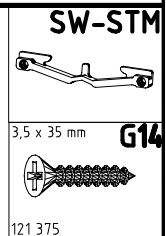
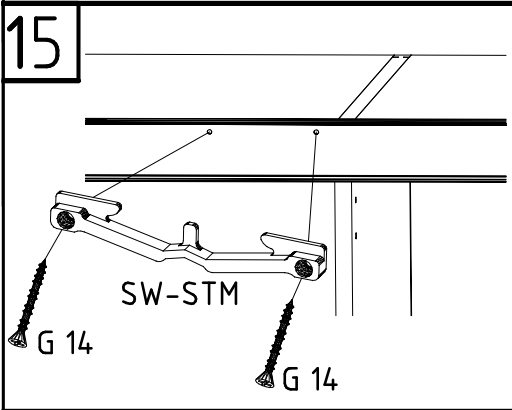

FPN
1316/1760
2204/2648/3092/3536

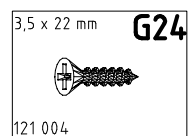

980863

11.12.13 / 20.11.17

11 17

9/12

16

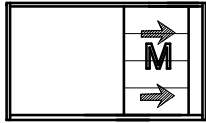
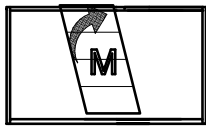

17

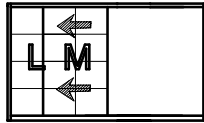
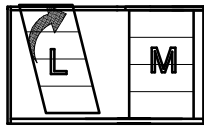

18

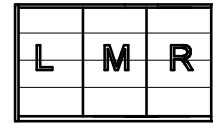
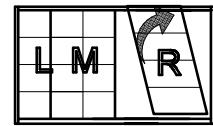

16

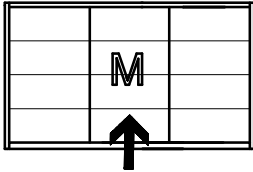

I.

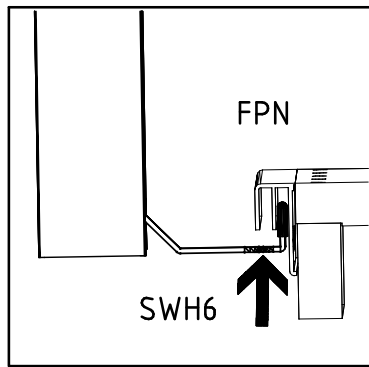

II.

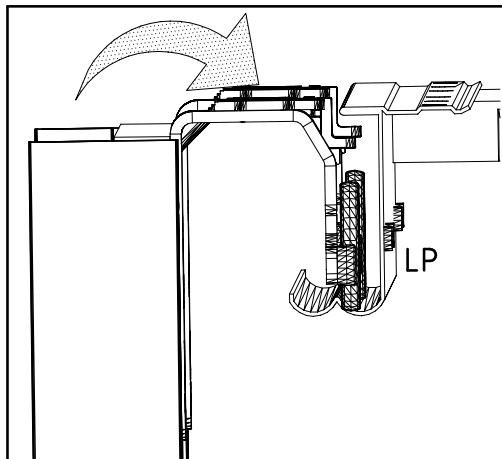
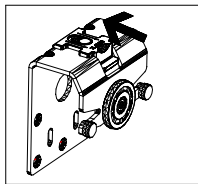

III.

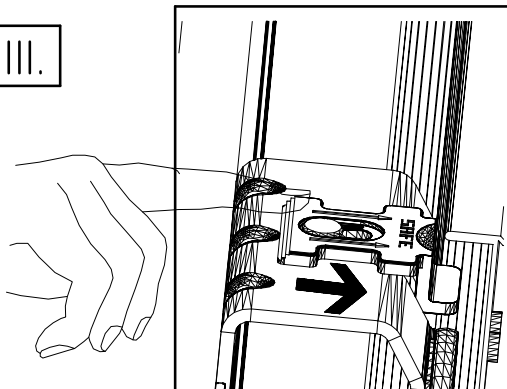

17 + 18

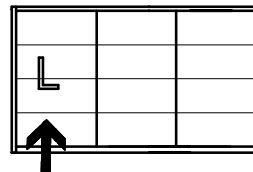

I.

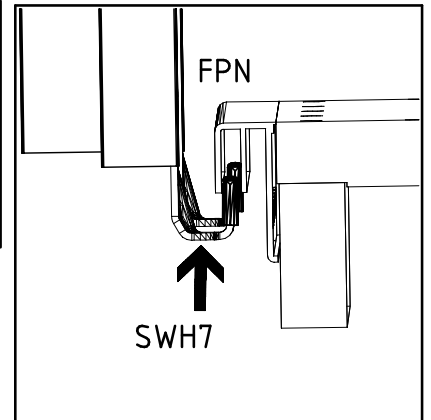
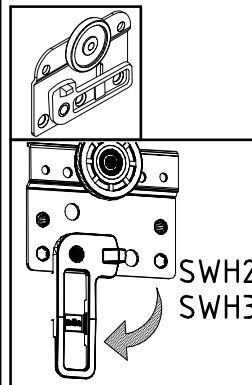

II.

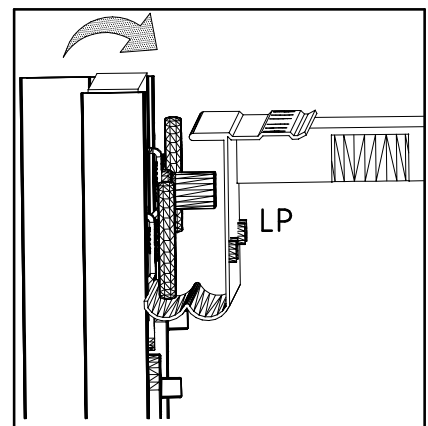

III.

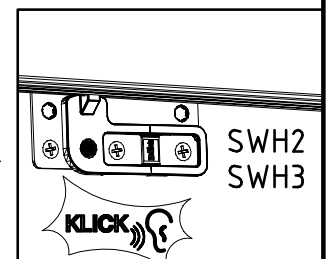
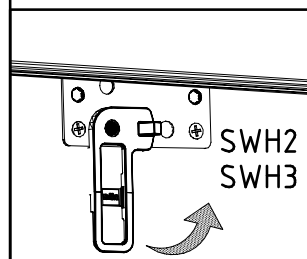

980863

11.12.13 / 20.11.17

11 17

10 / 12

19

