

ASSEMBLY INSTRUCTIONS

Questions?

GIVE US A CALL: 1-888-980-5122
MON-FRI 8:30AM - 5:30PM (PT)

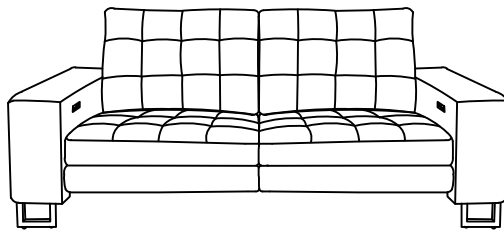
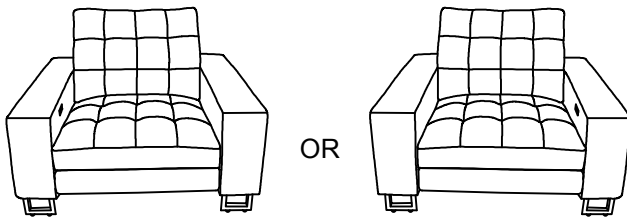

OR

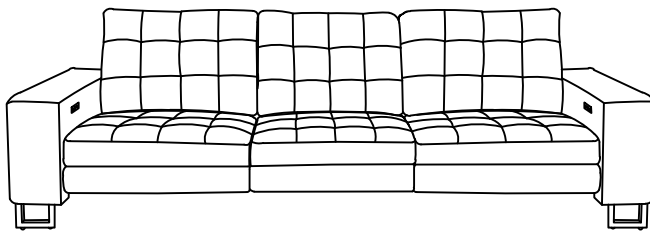

OR

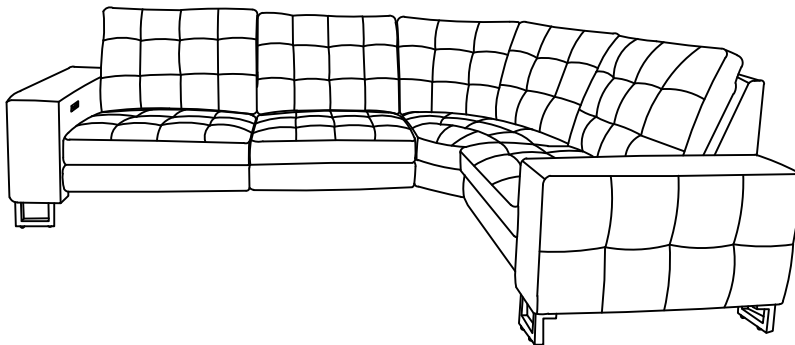

TOOLS REQUIRED



Allen Wrench

(Included)



**Phillips
Screwdriver**

(Not Included)

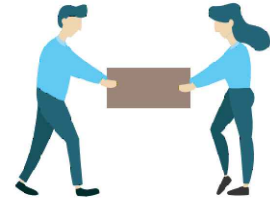

**2 - People
Recommended**

ASSEMBLY RATING

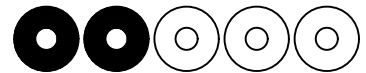

EASY —————> DIFFICULT

The Assembly Rating is a 5-point system showing the level of effort needed to assemble a specific product.



FOA Intro

Thank you for your purchase!

We hope you enjoy this new addition to your home for many years to come.

Our commitment to providing quality products does not simply end when you purchase our product. We fully stand behind our products from start to finish. Our customer service department is available Monday – Friday 8:30 AM – 5:30 PM Pacific Time and can help with assembly questions as well as, if necessary, replacing damaged or missing parts. To help expedite our service, please have these assembly instructions readily available, along with your order receipt.

 **Consumer Hotline**
Toll-Free 1-888-980-5122

 **WEBSITE**
www.foagroup.com

    foagroup

 **Monday to Friday**
8:30AM- 5:30PM (PT)

 **E-MAIL**
cs.ec@foagroup.com

 FurnitureOfAmerica

CHECK BEFORE STARTING

Are you missing anything?
Double-check all parts, hardware and accessories listed are all accounted for.

Should we send any replacements?
Are there any irregularities or flaws in the parts? We can send replacements!

Check out our Quick Tips!
We recommend reviewing the pre-assembly handouts. Even experts need a refresher now and then!

Prep Time!
Please review the assembly instructions and all diagrams prior to assembling.

PRE ASSEMBLY INTRODUCTION

We understand building ready-to-assemble furniture can be a challenging experience for some. To help avoid confusion, we have provided some helpful tips that may speed up the process.



Teamwork

ALWAYS have at least two people to help with transporting and assembling the product to avoid potential injury and/or damage.

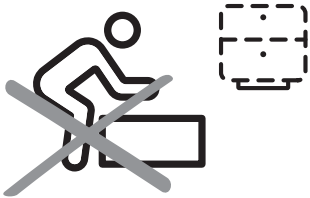

Suitable Location

Assembling near the area of the intended location is highly recommended.



Sufficient Space

Make sure you have enough space to move around during the assembly.



Avoid Scratches

Use cardboard, blankets or a carpeted area while assembling furniture to prevent to prevent scratches and damages.

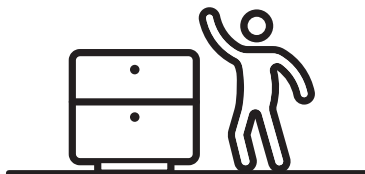

Flat Surface

Make sure the furniture rests on a flat and level surface with each leg evenly touching the floor.

ASSEMBLY AND CARE ADVICE



FAILURE TO FOLLOW THE GUIDELINES BELOW MAY RESULT IN INJURY AND/OR PROPERTY DAMAGE.



Position each part correctly and insert screws or bolts into their respective holes.

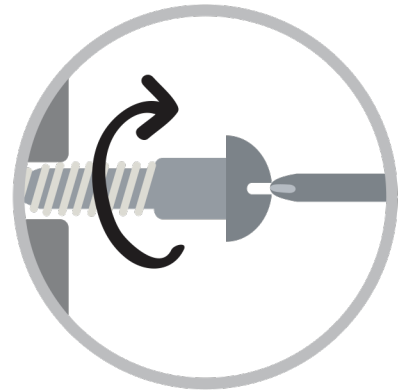

Turn clockwise to tighten and only tighten when step is completed or when instructed to do so.



Use the appropriate hand tools or power tools for assembly. Select steps, such as tightening screws and/or bolts, may require hand tools to avoid causing damage during assembly.



Save the instructions and store any supplied tools for later maintenance.

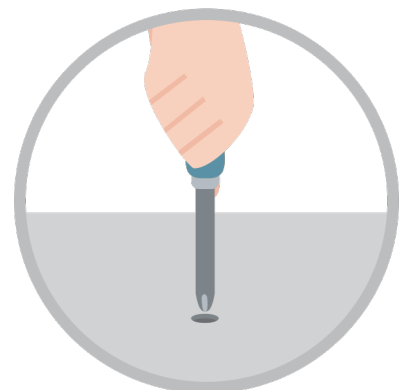

After two weeks, check and tighten any loose hardware and repeat again every six months thereafter.

IT IS THE USER'S RESPONSIBILITY TO MAINTAIN THE FURNITURE. THE HARDWARE MAY LOOSEN OVER TIME AND MAY CAUSE THE FURNITURE TO BE WOBBLY AND UNABLE TO SUPPORT ITS INTENDED WEIGHT CAPACITY. THIS MAY LEAD TO COLLAPSE AND MAY CAUSE SERIOUS INJURY.

SOFA

CM6735



- Please keep instructions for future reference.
- Check the quantity and irregularity of parts and hardware before you start.

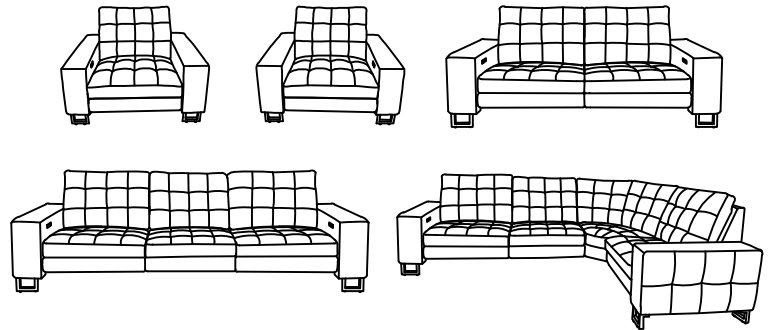

PARTS

#1 1pc

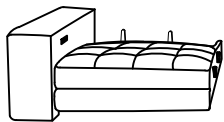

Left Chair

#2 1pc

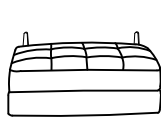

Armless Chair

#3 1pc

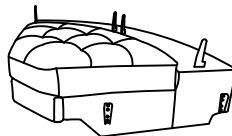

Corner

#4 1pc

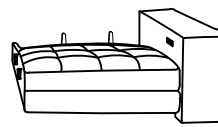

Right Chair

#5 2pcs

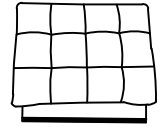

Left/Right Chair Backrest

#6 1pc

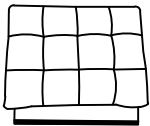

Armless Chair Backrest

#7 1pc

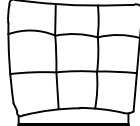

Left Corner Backrest

#8 1pc

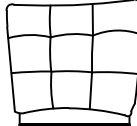

Right Corner Backrest

#9 1pc

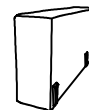

Left Arm

#10 1pc

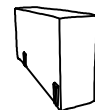

Right Arm

HARDWARE

#A 2pcs



Power Adaptor

#B 2pcs



Plug With Wire

#C 16pcs



Bolt 5/16"X2-1/4"

#D 16pcs



Spring Washer Ø5/16"

#E 16pcs



Flat Washer Ø5/16"

#F 4pcs

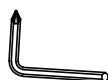

Allen Key / Screwdriver
5MM

#G 16pcs



Screw
M4x50MM

#H 8pcs













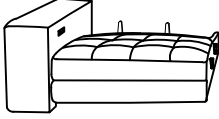









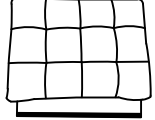
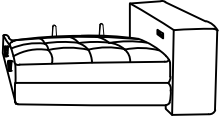









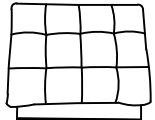
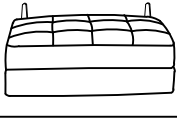

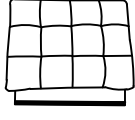
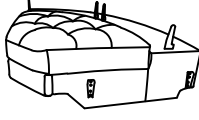

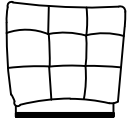
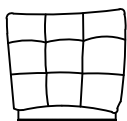
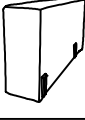



Arm Legs

#I 17pcs



Legs

CM6735 is packed in 6 cases

Carton	Disignation	Part		Hardware
CM6735-LCH	Left chair	#1		 #H x 2pcs  #G x 4pcs  #C x 4pcs  #D x 4pcs  #E x 4pcs  #I x 4pcs  #F x 1pc  #A x 1pc  #B x 1pc
	Left chair Backrest	#5		
CM6735-RCH	Right chair	#4		 #H x 2pcs  #G x 4pcs  #C x 4pcs  #D x 4pcs  #E x 4pcs  #I x 4pcs  #F x 1pc  #A x 1pc  #B x 1pc
	Right chair Backrest	#5		
CM6735-AC	Chair	#2		 #I x 4pcs
	Backrest	#6		
CM6735-CNR	Corner	#3		 #I x 5pcs
	Left corner Backrest	#7		
	Right corner Backrest	#8		
CM6735-LARM	Left Arm	#9		 #H x 2pcs  #G x 4pcs  #C x 4pcs  #D x 4pcs  #E x 4pcs  #F x 1pc
CM6735-RARM	Right Arm	#10		 #H x 2pcs  #G x 4pcs  #C x 4pcs  #D x 4pcs  #E x 4pcs  #F x 1pc

Exploded View

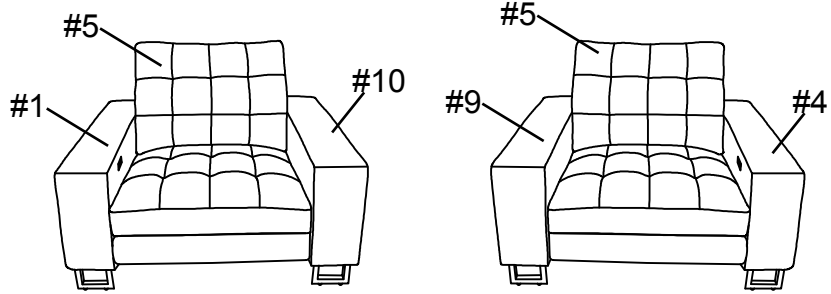

OR

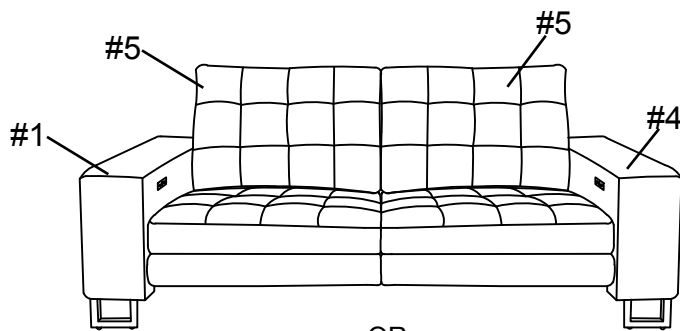

OR

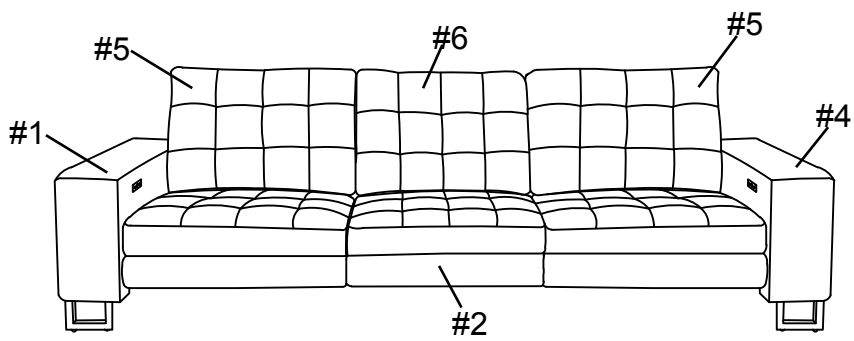

OR

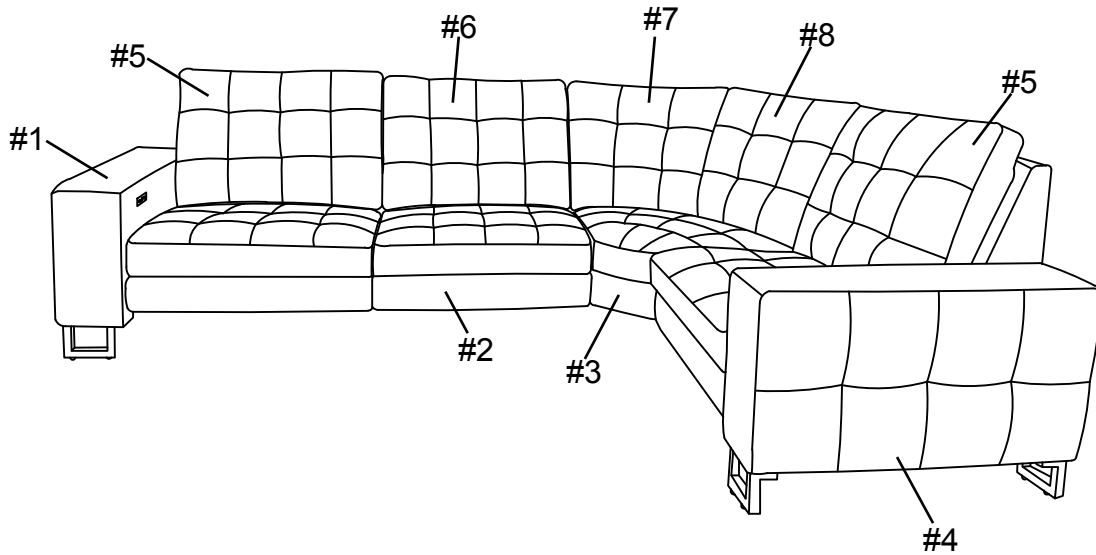

ASSEMBLY INSTRUCTIONS

I. Twist the Legs (#1) onto the corners of the Left/ Right Chair cushion (#1,#4).

1

- Part #1 x1pc
- Part #4 x1pc
- Hardware #C x8pcs
- Hardware #D x8pcs
- Hardware #E x8pcs
- Hardware #F x1pc
- Hardware #G x8pcs

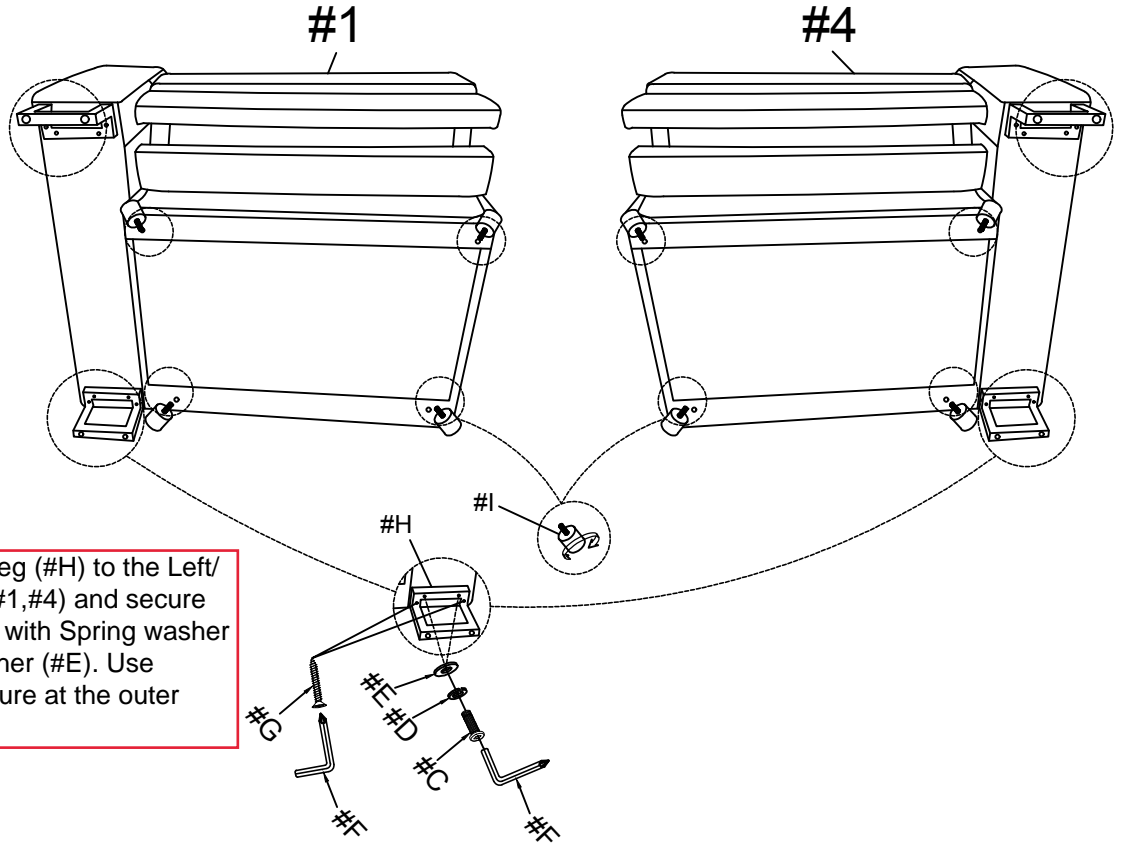

II. Align the Arm Leg (#H) to the Left/ Right Chair Arm (#1,#4) and secure by using Bolt (#C) with Spring washer (#D) and Flat washer (#E). Use Screw (#G) to secure at the outer holes.

2

- Hardware #H x9pcs

Twist the Legs (#1) onto the bottom of the Armless chair (#2) and Corner (#3).

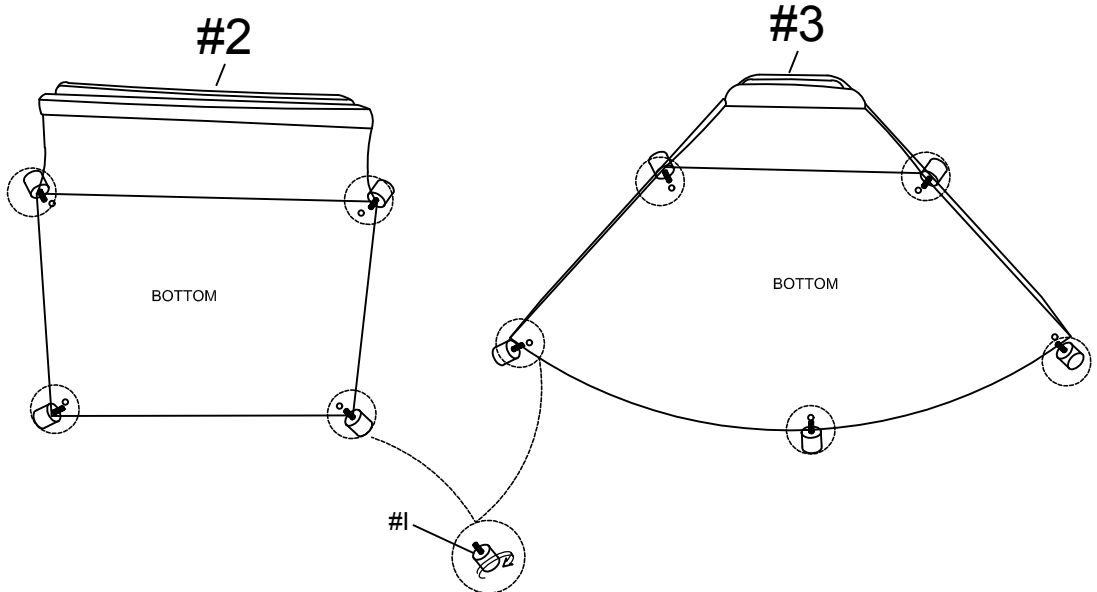

ASSEMBLY INSTRUCTIONS

Align the Arm Leg (#H) to the Left Arm (#9) and the Right Arm (#10) secure by using Bolt (#C) with Spring washer (#D) and Flat washer (#E). Use Screw (#G) to secure at the outer holes.

3

Part (#9) x1pc

Part (#10) x1pc

Hardware (#C) x8pcs

Hardware (#D) x8pcs

Hardware (#E) x8pcs

Hardware (#F) x1pc

Hardware (#G) x8pcs

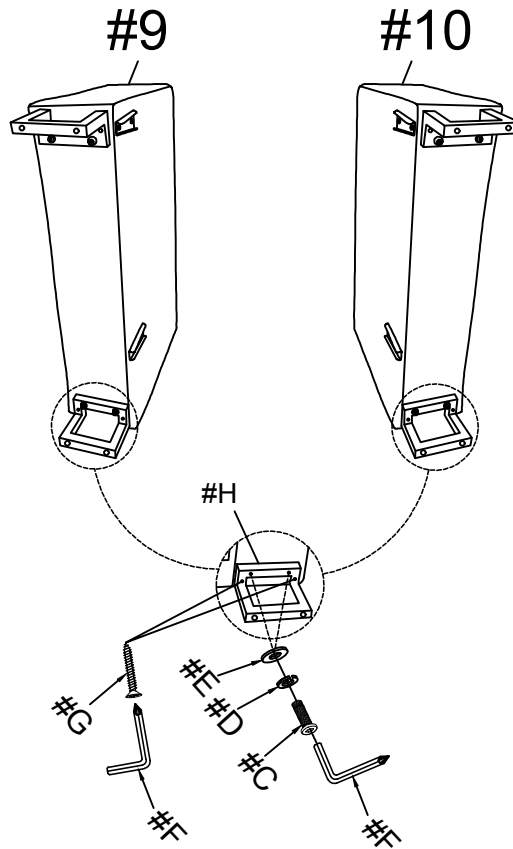

4

Lift and insert the bracket along the Left Chair (#1) to the bracket on the Right Arm (#10). Slide until secure.

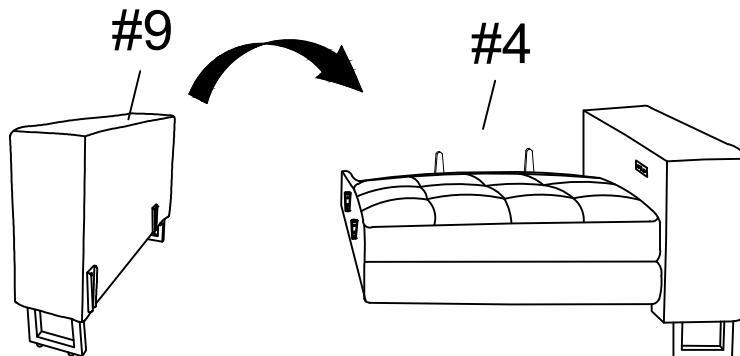
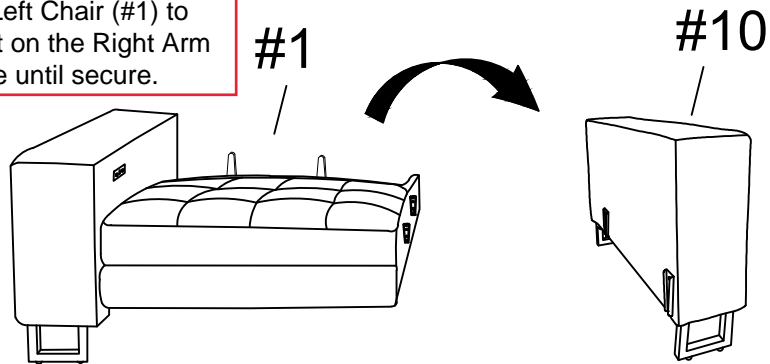

Lift and insert the bracket along the Right Chair (#4) to the bracket on the Left Arm (#9). Slide until secure.

ASSEMBLY INSTRUCTIONS

Lift and insert the bracket along the Left Chair (#1) to the bracket on the Right Arm (#4). Slide until secure.

5

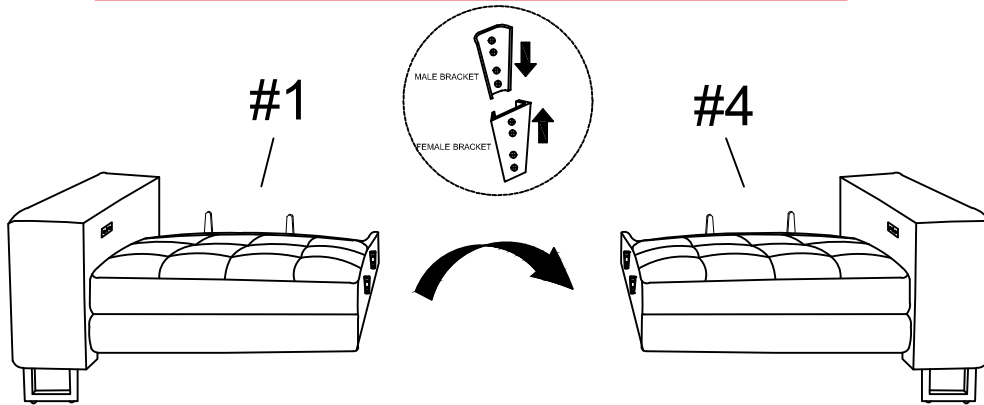

Lift and insert the bracket along the Left Chair (#1) to the bracket on the Armless chair (#2). Slide until secure. Lift and insert the bracket along the Armless chair (#2) to the bracket on the Right chair (#4).

6

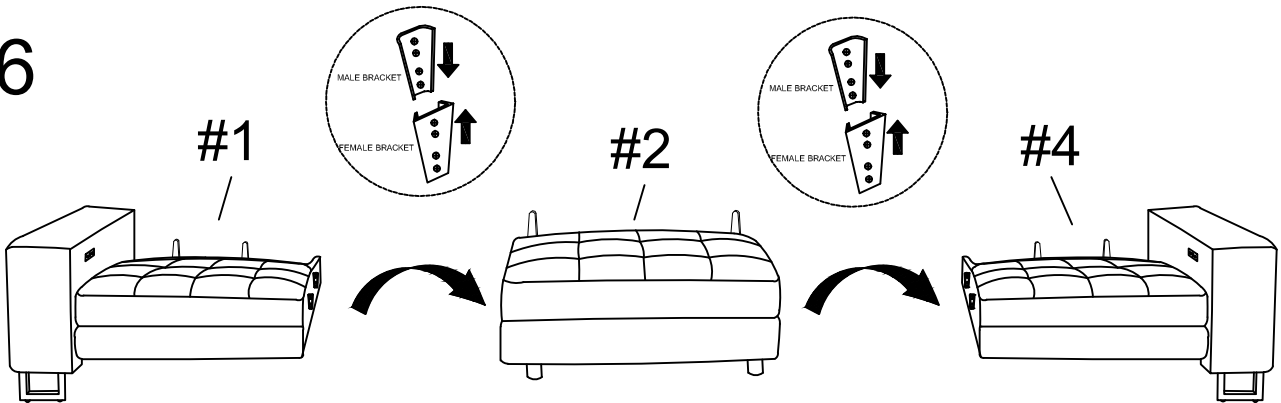

7

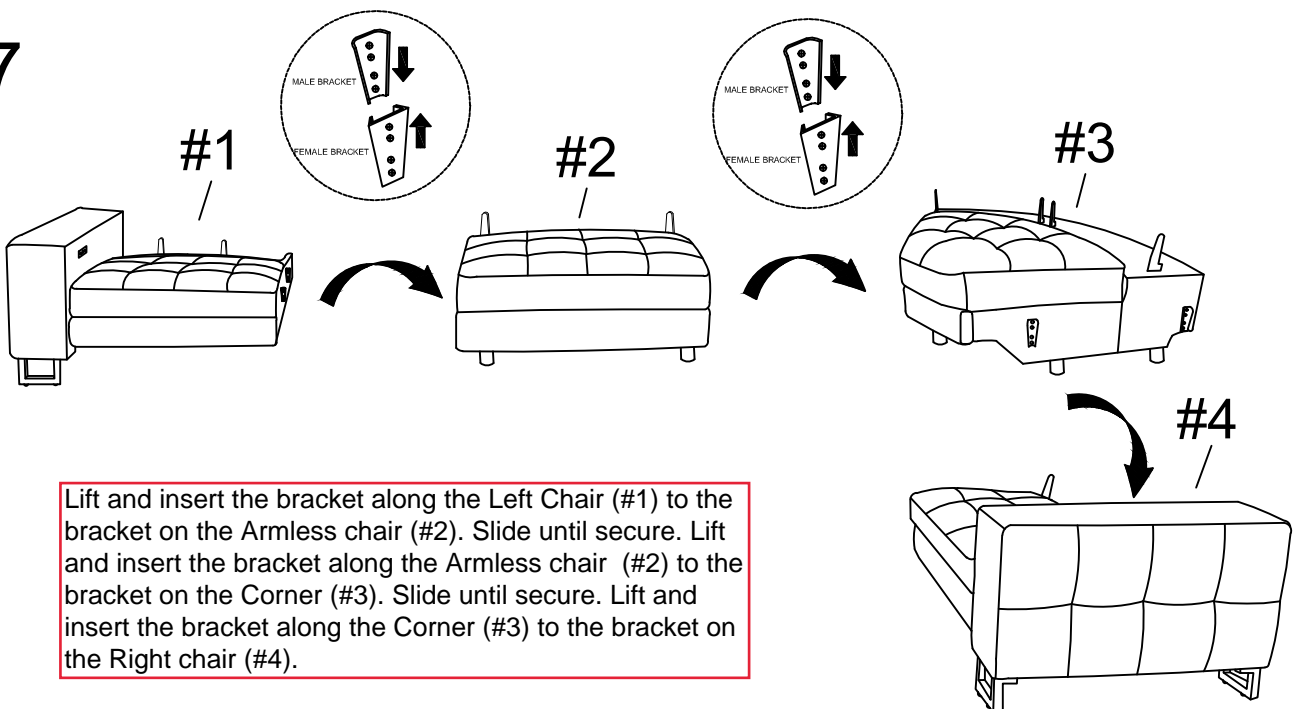

Lift and insert the bracket along the Left Chair (#1) to the bracket on the Armless chair (#2). Slide until secure. Lift and insert the bracket along the Armless chair (#2) to the bracket on the Corner (#3). Slide until secure. Lift and insert the bracket along the Corner (#3) to the bracket on the Right chair (#4).

ASSEMBLY INSTRUCTIONS

8

Align the brackets on the Left/Right C Backrest (#5) to slide into the brackets along the Left chair (#1) until firmly secured.

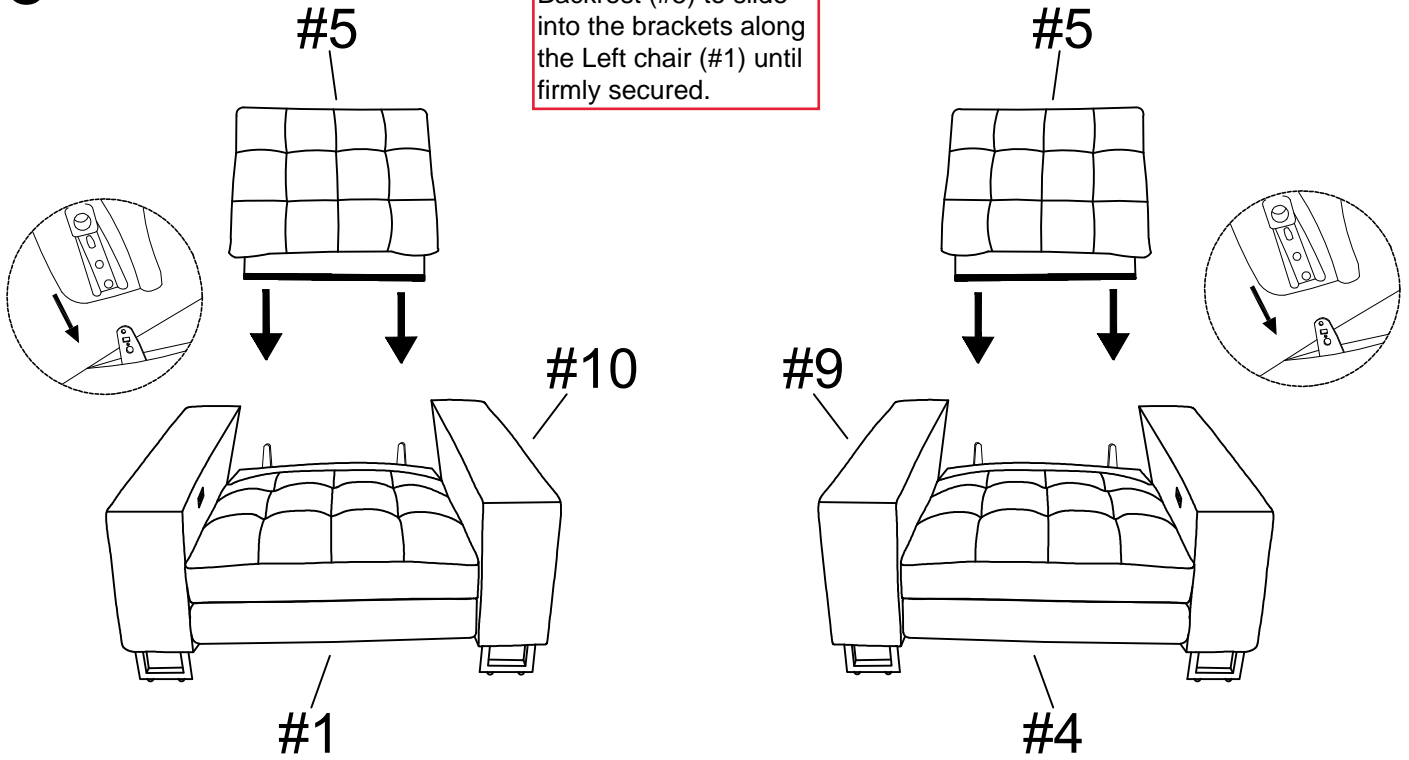

9

Align the brackets on the Left/Right C Backrest (#5) to the bracket onto the chairs (#1, #4). Slide in until secure.

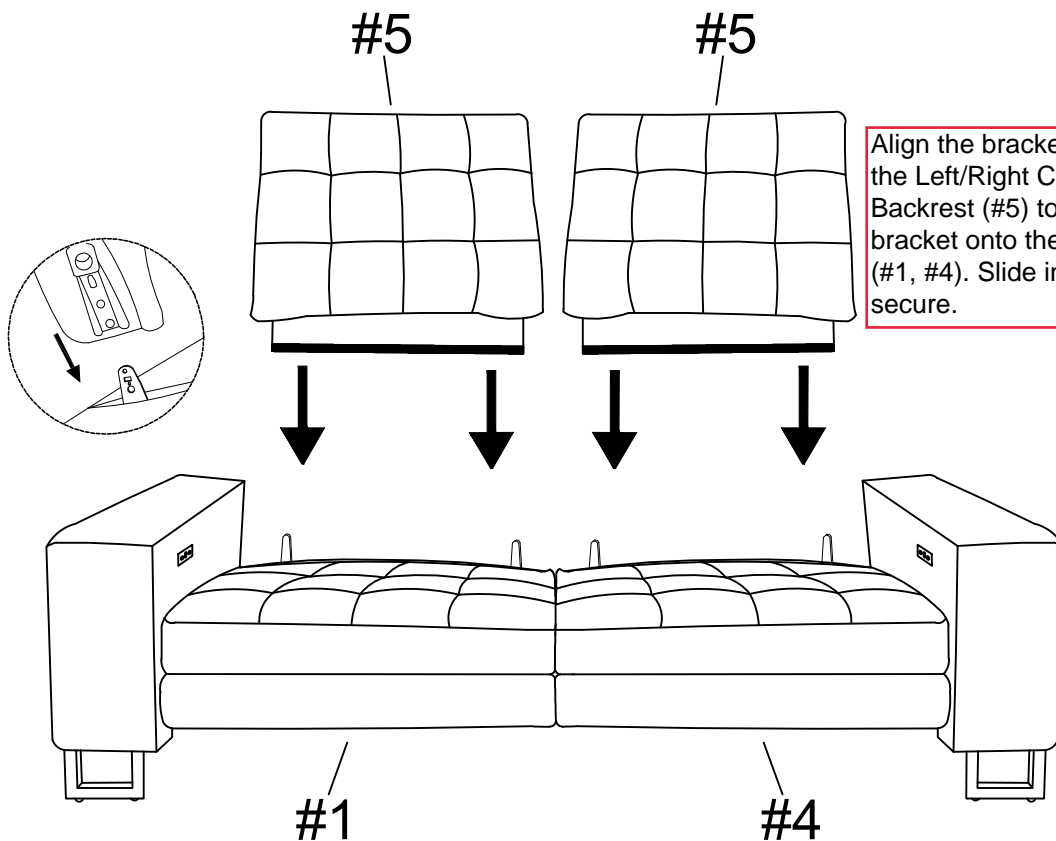

ASSEMBLY INSTRUCTIONS

Align the brackets on the Left/Right C Backrest (#5) and Armless chair bracket (#6) to the bracket onto the chairs (#1,#2, #4). Slide in until secure.

10

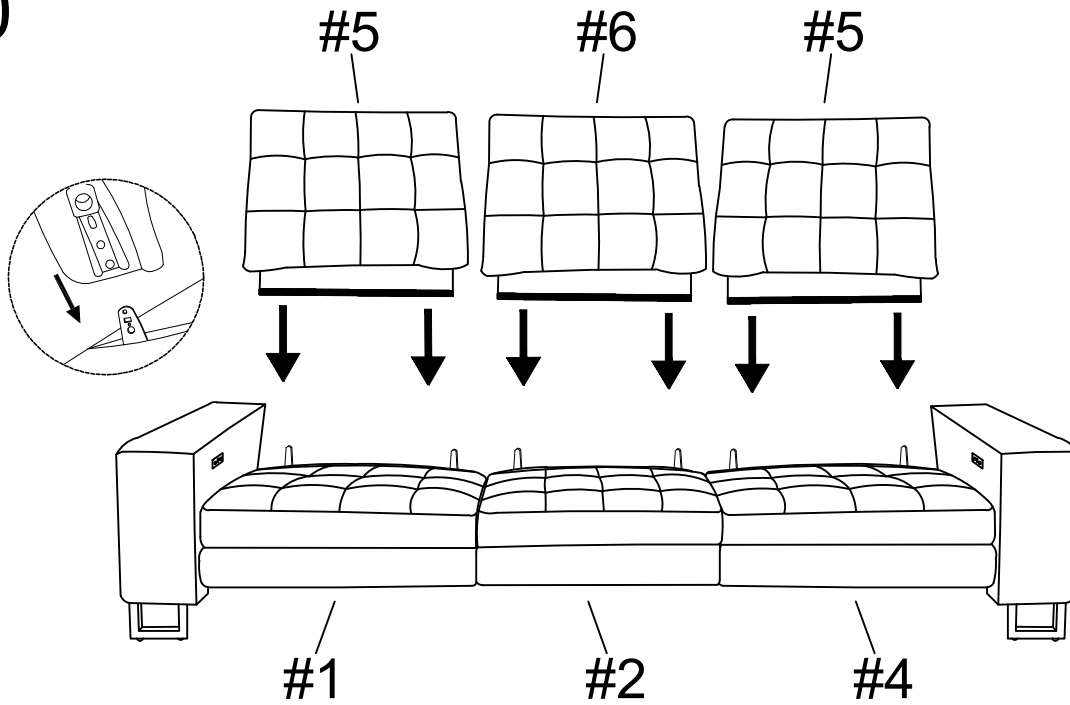

11

Align the brackets on the Left/Right C Backrest (#5), Armless chair backrest (#6), and Corner Backrest (#7,#8) to the bracket onto the chairs (#1, #2,#3, #4). Slide in until secure.

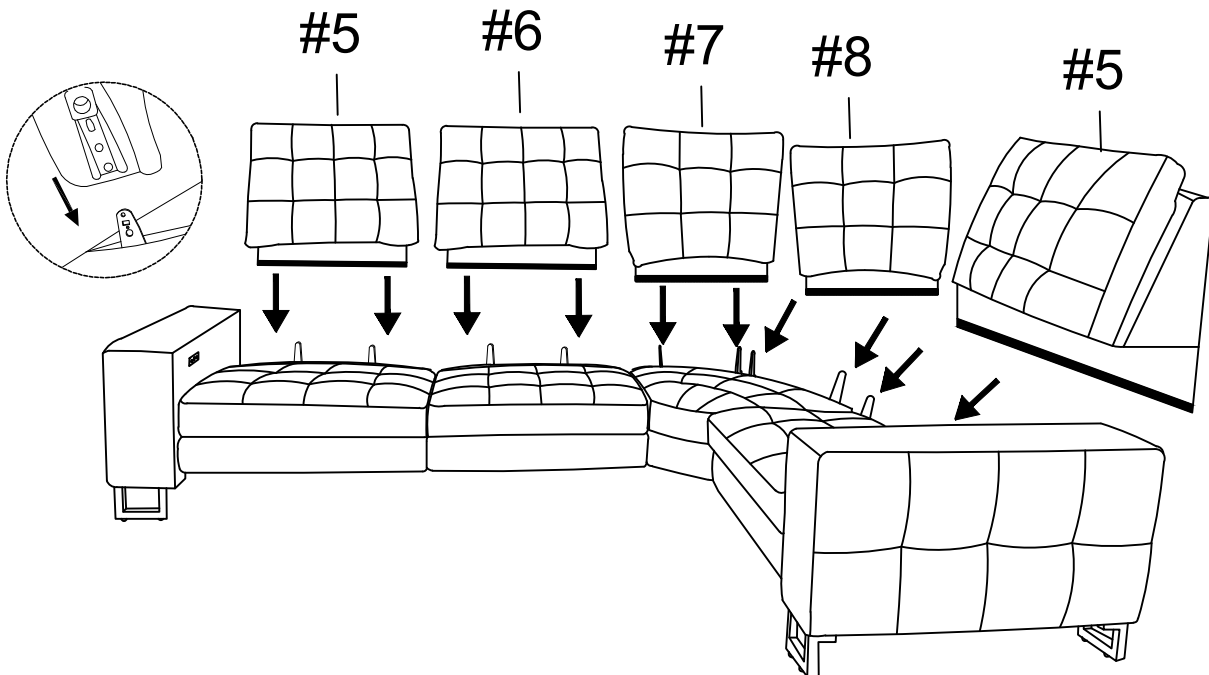

ASSEMBLY INSTRUCTIONS

12

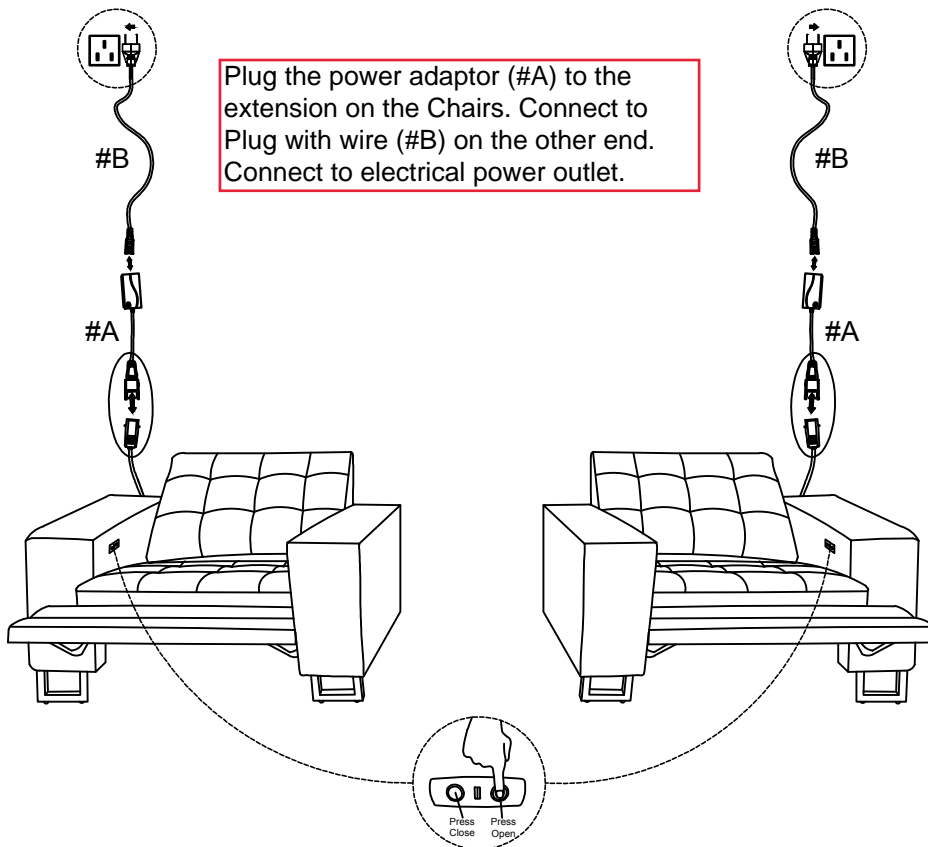

13

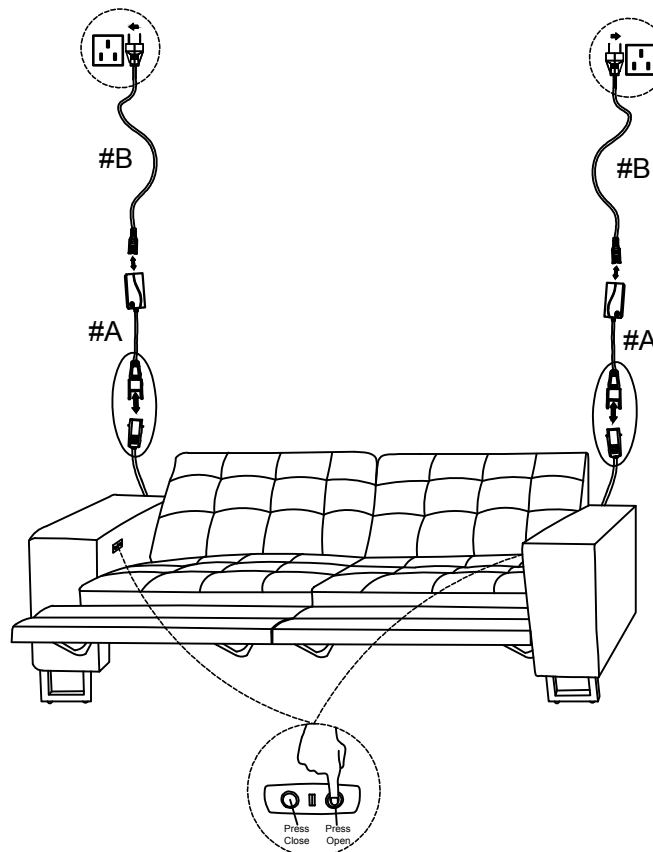

ASSEMBLY INSTRUCTIONS

14

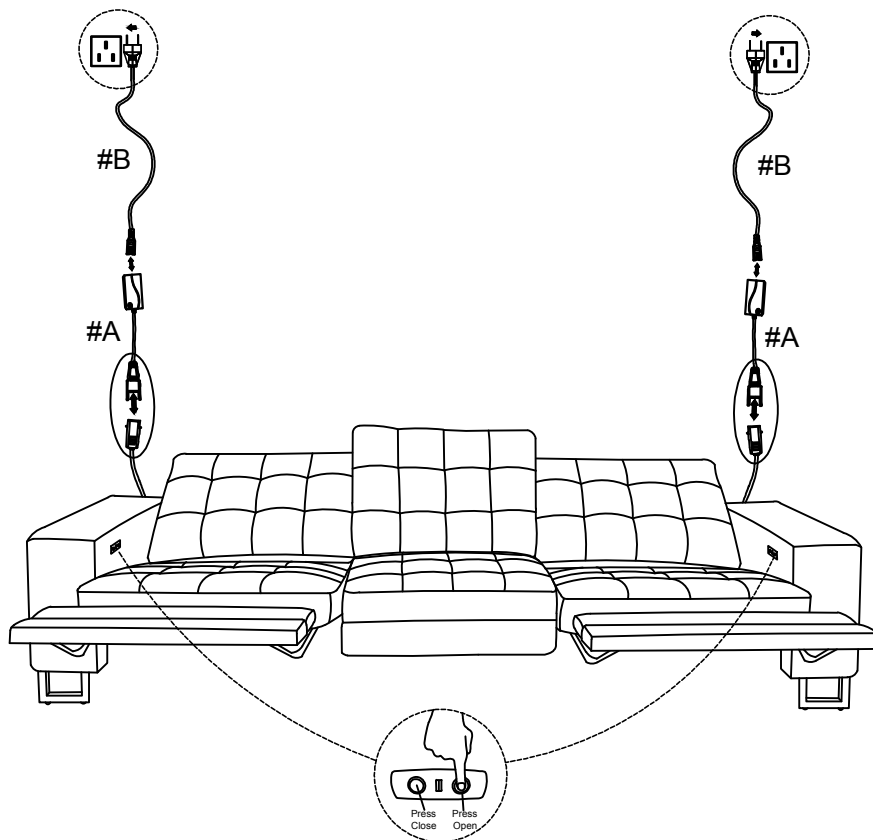

15

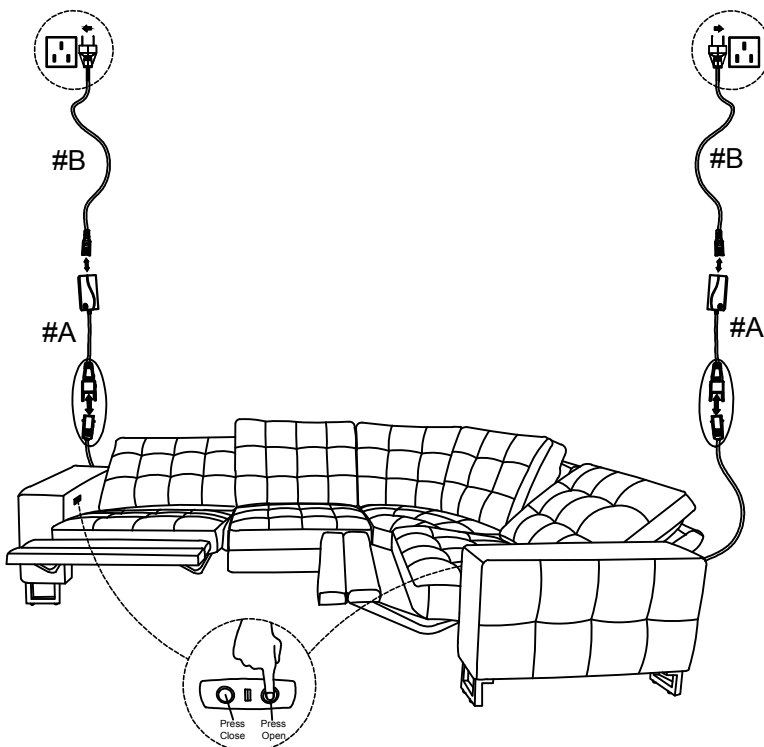

ASSEMBLY COMPLETED



Please ensure the furniture rests on an even and flat surface. If the product wobbles or feels loose, double-check all bolts and/or screws are properly tightened and secured.



Keep this handy!

Please retain this instruction manual and any order-related information for future reference.



Lift, don't drag!

To avoid damage to product please always LIFT the product when transporting or adjusting the placement.