

230 Gal on Deck Box

Owner's Manual

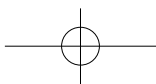
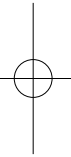
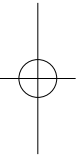
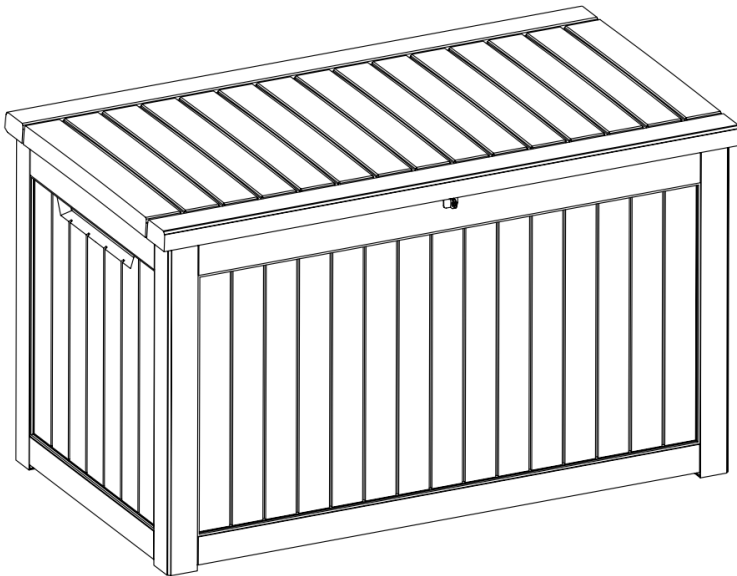

IMPORTANT CAUTION

Once installed, the product cannot be detached. Please strictly follow each step in the installation manual.

- Please check all parts and components to ensure that there are no damages or missing items before starting the construction of the product. If you have any problems or discover any missing parts, please contact customer service
- Some parts may contain sharp edges. Wear protective gloves if necessary during assembly.
- When using power tools, please adjust the gear to the minimum, otherwise it will cause damage to the parts.

ASSEMBLY INSTRUCTIONS

- DO NOT assemble this item alone for your safety. Two people are necessary for smooth and safe installation.
- We recommend using a rubber hammer and an electric screwdriver for better installation.
- Item identification: For ease of identification, all parts are labeled to correspond to the step number in which the part is used.
- **Tips: When installing the screws, fix them first, and then tighten the screws after they are all positioned.**

CARE & SAFETY

- Check all panels for tightness before usage.
- It is of utmost importance to assemble all parts according to the directions. Do not skip any step.
- In case of fire, do not attempt to extinguish any burning polypropylene with water.
- Wear safety goggles and always follow the manufacturer's instructions when using power tools.
- Using a stiff brush or abrasive cleaner could damage the box.
- Hot items such as recently used grills, blowtorches, etc., must not be stored in the box.
- After rain, wipe the box with cloth before opening.
- Unsuitable for the storage of flammable or corrosive substances.
- Do not stand on the lid.
- To prevent the risk of suffocation, do not allow children to play inside the box.

PARTS LIST

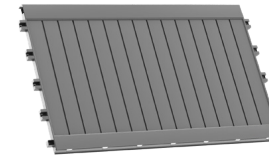

Front Panel
A (X1)



Back Panel
A (X1)



Side Panel
C (X2)

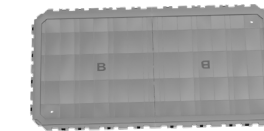

Bottom Panel
B (X1)

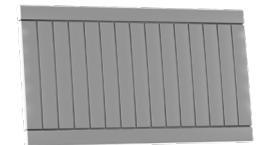

Lid Panel
J (X1)



Role
G (X4)

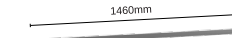

Reinforced Metal Rod
R1 (X1)

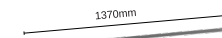

Reinforced Metal Rod
R2 (X2)



Lock Bracket-1
V (X1)



Lock Bracket-2
I (X1)



Plastic Strip
T (X1)



Screw
M (X30) + Spare(X2)



Plastic Hinge
E (X1)



Side Panel Reinforced Bridge
G2 (X4)



Rubber Plug
Q (X2)



Hydraulic Rod
H (X2)

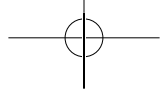

1 ASSEMBLY INSTRUCTIONS

Align 2 Rubber Plugs Q with the hole and install it on Panel B.

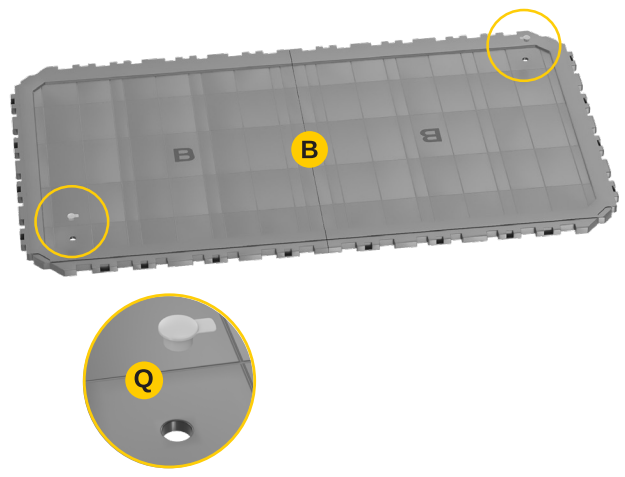
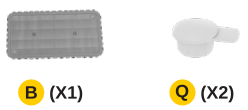

2

Put a Panel A on the ground, then install Panel B and the other Panel A on it.

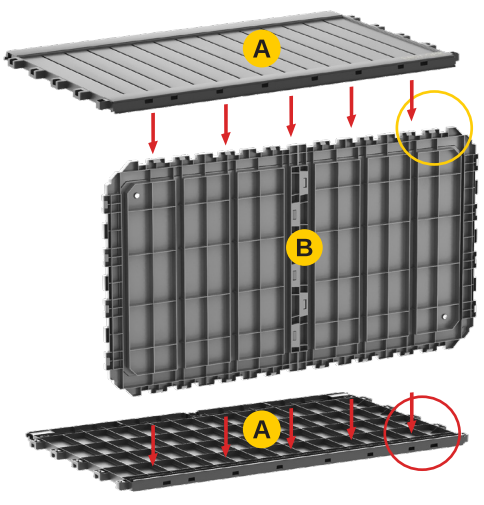
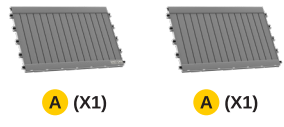

ground

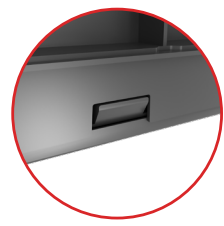

3

Install 4 Roles G to 2 Side Panels C. Please keep the direction of the arrows on the G and C consistent.

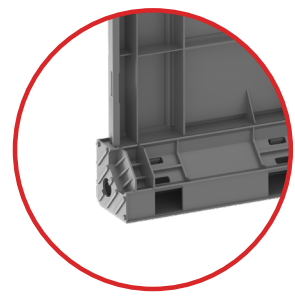
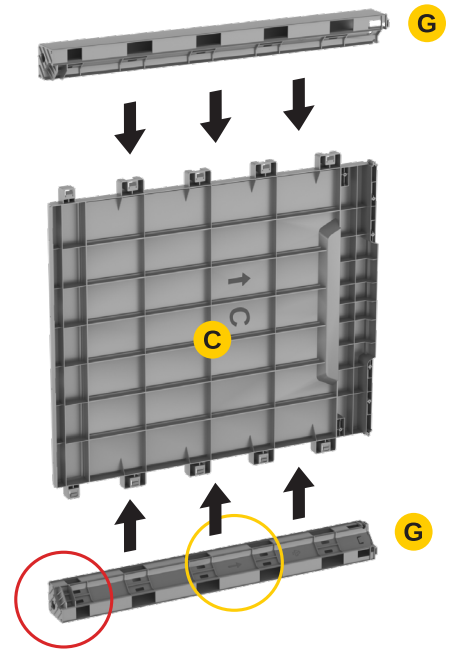
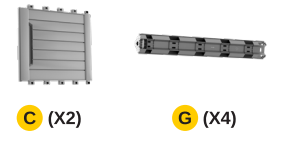

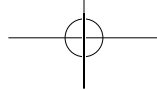

4

Be sure to match Panel A,B,C correctly.

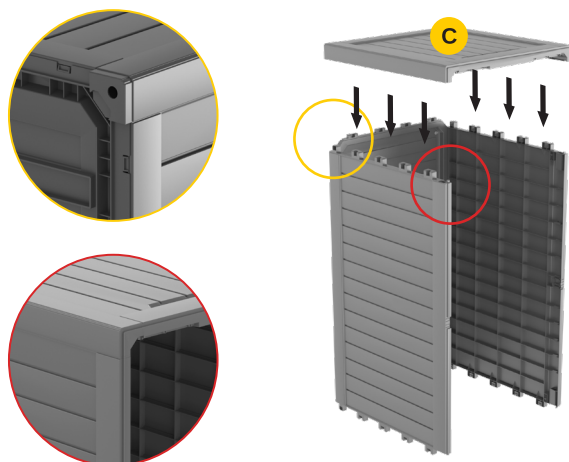

ground

6

Repeat step 4 and install another Side Panel C. Please using rubber mallet for convenient installation.

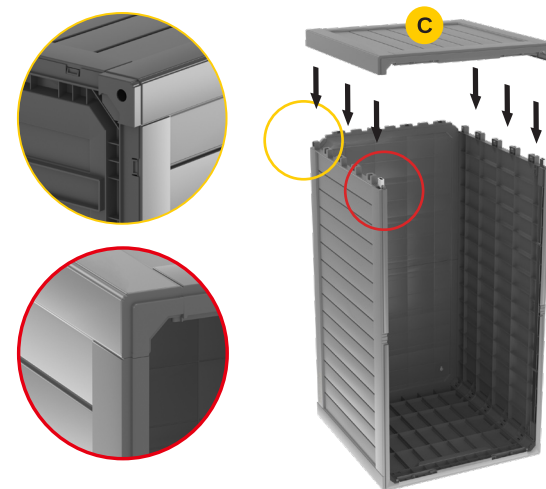

5

Install 2 Reinforced Metal Rods R2 to Panel A, making sure the rods are inserted to the end of the card slot.

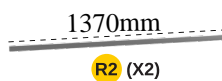
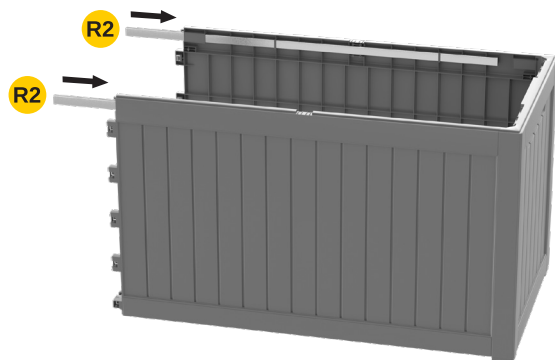

7

Install Lock Bracket-2 I and Plastic Strip T to Front Panel A with 3 Screws

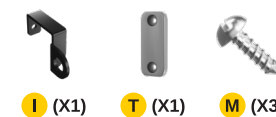
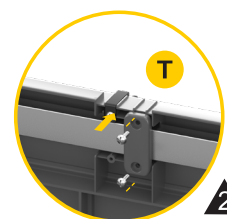
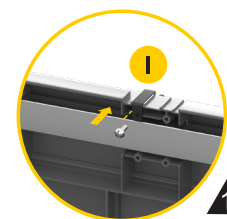

8

Install 4 Side Panel Reinforced Bridge G2 to the corners of the box with 8 Screws.

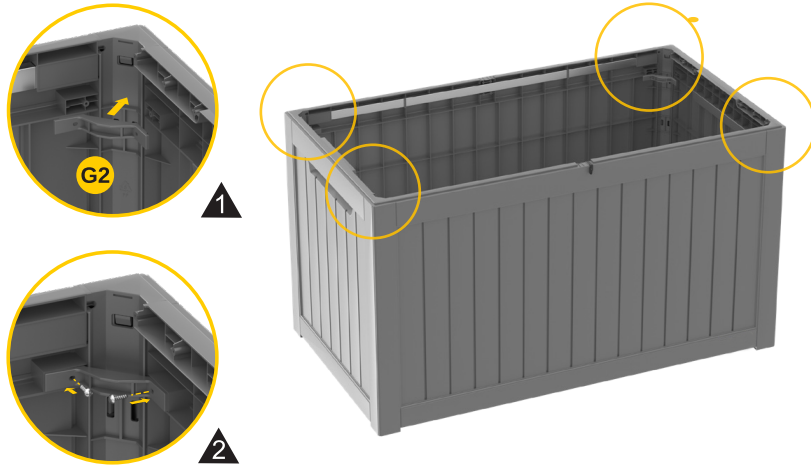

10

Install Lock Bracket-1 V and Plastic Hinge E to Lid Panel J.

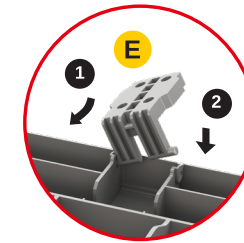
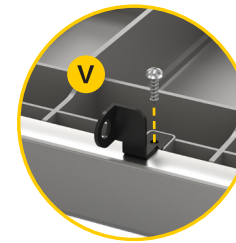
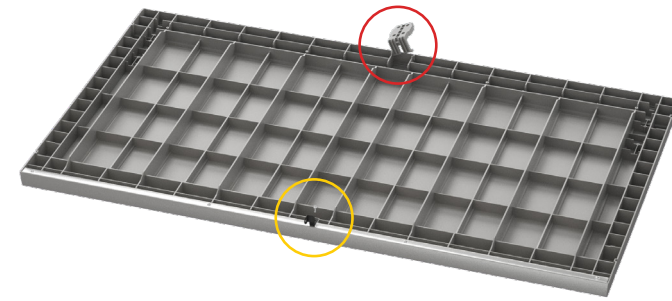

For easier installation, Plastic Hinge E should tilt to one side.

9

Please attach the Reinforced Metal Rod R1 to Lid Panel J.

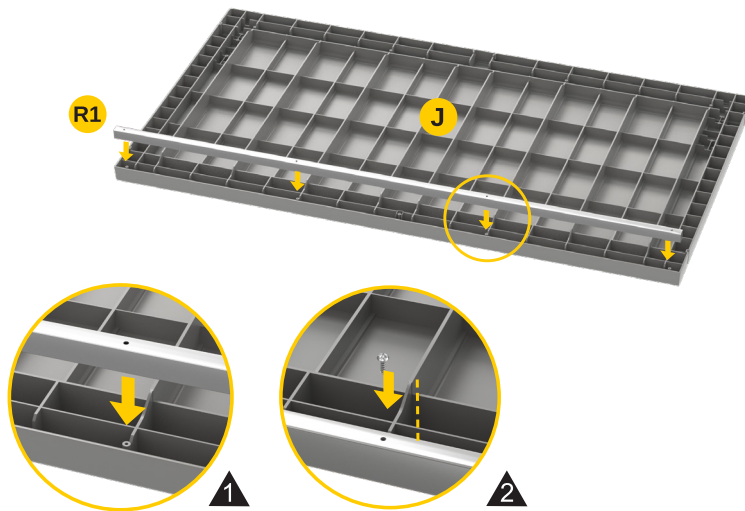
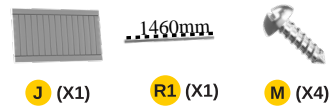

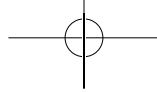

11

Assemble 2 Hydraulic Rods H to Lid Panel J with 4 Screws.

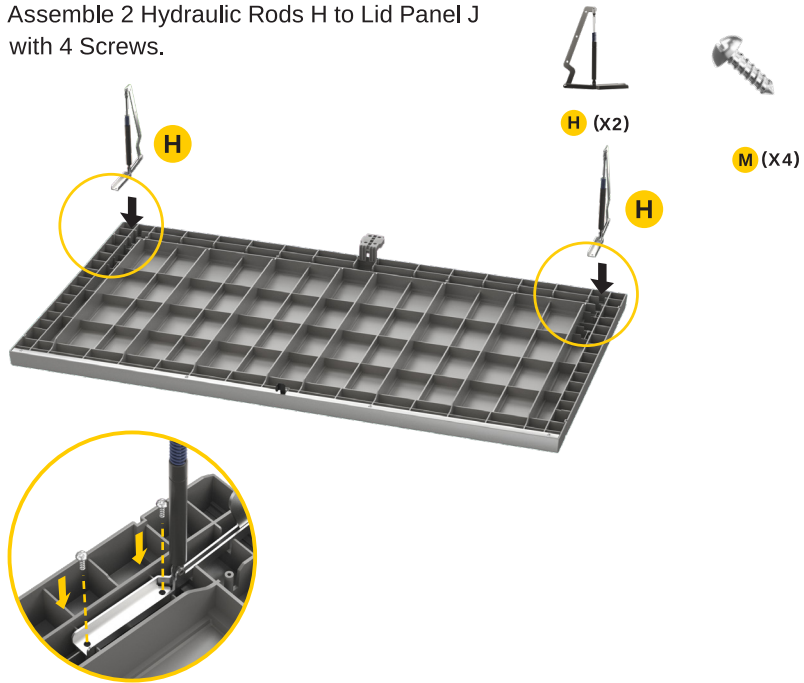

13

Tighten Plastic Hinge E with 4 Screws.



12

Assemble 2 Hydraulic Rods H to Side Panel C with 6 Screws.

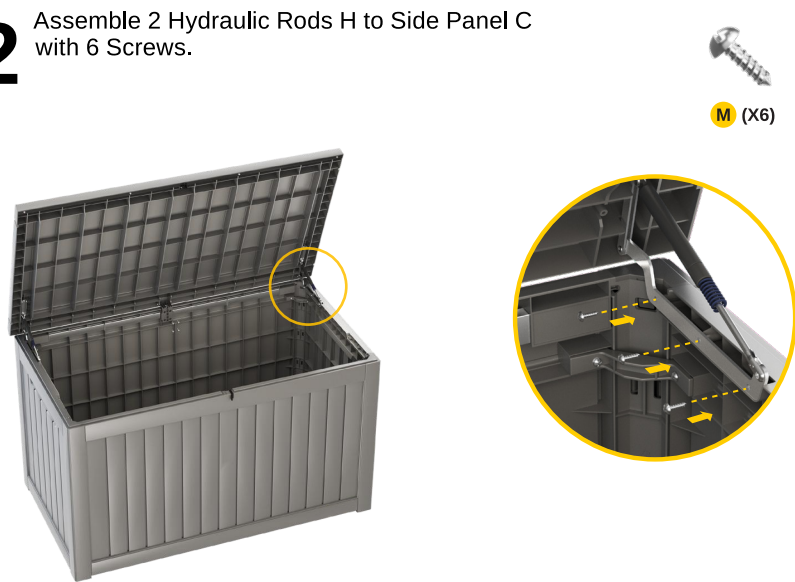

14

Installation completed.



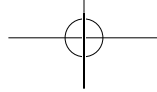

FEATURES

- Weatherproof and Waterproof Outdoor Furniture
- UV and Fade Resistance
- Durable and Long-lasting Use
- Easy to Assemble
- Marine-grade Quality Hardware
- Comfortable Side Handles
- Upgraded PP Material to Prevent Bending and Fading
- Use for Indoors and Outdoors, Pillows, Pool Toys, Garden Tools, Furniture and Sports Equipment
- Great Option for Home Storage and Organization

WHAT'S IN THE BOX

- 6 Deck Box Assemblies
- 4 Roles
- 3 Reinforced Metal Rods
- 2 Hydraulic Rods
- Screw Package
- User Manual

Product use and maintenance recommendations

1. At regular check the deck box to ensure that it's stable and assembly integrity has been maintained.
2. This deck box should be far away from the open flame.
3. If use outdoor, please keep the deck box in a dry and flat place and covered with rainproof cloth on the roof
4. If the environment permits, install the deck box in a cool place, as prolonged expo-sure to direct sunlight may deform the panel and accelerate aging.
5. Do not store hot items (recently used grills, blowtorches etc.), flammable or caustic chemicals in the deck box.
6. Wash with a mild soap and water if there is any stain on the deck box. Do not use a stiff brush, bleach, ammonia or any other caustic cleaners, as these may damage the deck box or could result in permanent staining of the plastic. This is not manufacturing defect and is not covered under warranty.

Return policy

1. For return and exchange orders:

(1) If the deck box you received is damaged or defective and need to be returned or replaced with new one, please kindly send us real images (product itself or packag-es). We will check and deal with it quickly.

(2) For product quality reason return and exchange orders: please take real images and contact us, we will provide prepaid return label for return or replace new product.

(3) For these reasons (bought by mistake, no longer needed, does not meet expectation, size smaller or bigger than expectation) return and exchange orders: customer need to cover the return shipping costs.

2. For cancel order: customer need to pay for shipping fee and carrier handle fee if the item has been shipped out.

3. For change address: customer need to pay for extra shipping fee and carrier handle fee if the item has been shipped out.

Return process:

1. Make a RETURN REQUEST on the Amazon.

2. Please ensure the integrity of the items and write the detailed information about return address, and then return the item.

3. Please inform us the tracking number of the returned package if you returned the item, this information is necessary for us. Otherwise, we don't know when you returned the item to the warehouse and can not refund in time.

4. Warehouse will checking the return item within 3 business days after receiving it, and we will complete the refund within 2 days if the item is confirmed to have no problems.

Please note:

If returned defective, damaged or incorrect item and affects the re-sales, we will refund part of the money. The refund depends on the integrity of the package.

Warranty:

If there have product quality problem or the Installation Manual is not clear, please contact us, we will deal with it quickly

Due to defects resulting from normal wear and tear (scuffing, scratches caused during use, fading, abuse, unreasonable use, transporting or reassemble the product), natural disasters (storm, hail, flood and fire) and by animal types are not covered by the product warranty)