

# NOTICE BEFORE ASSEMBLY

Please choose the CHAISE will be on the LEFT or RIGHT hand side

THE CONSOLE PIECE CAN BE TILTED DOWN AND TURN INTO AN ARM REST PANEL WITH CUP HOLDERS

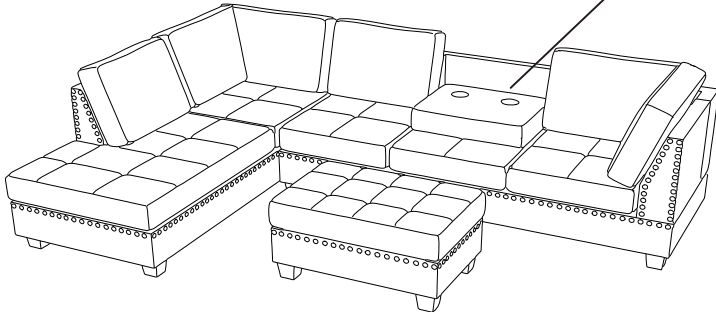

CHAISE ON THE LEFT

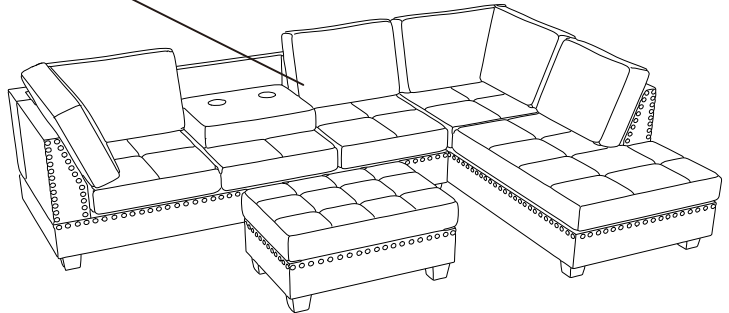

CHAISE ON THE RIGHT

## PARTS LIST

### BOX-1

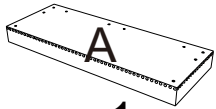

x1



x1

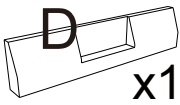

x1



x2



x2

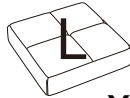

x3

### BOX-2

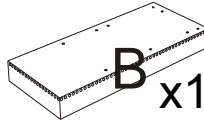

x1



x1



x1



x1



x2



x1

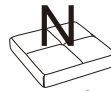

x1

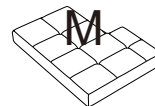

x1

### BOX-3

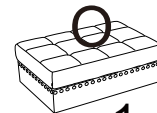

x1



x1

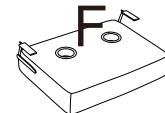

x1

## HARDWARE LIST



5/16" x30

H1

x12



M8 x22

H2

x12



5/16" x12

H3

x12



H4

x1



1/4" x25

H5

x4



H6

x1

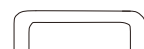

H7

x2



H8

x12

Open up the velcro of Non-Woven Fabric cover on the bottom of the seat frame to remove seat cushions, back cushions and pillow

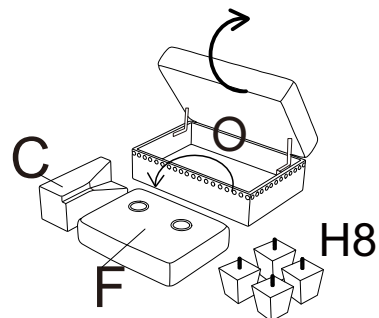
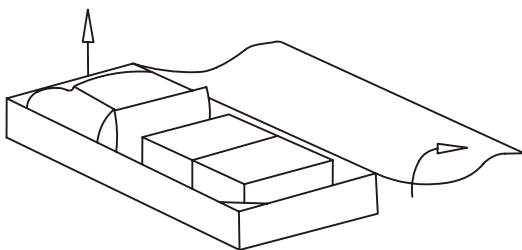

Remove hardware from inside the ottoman

\*\*\*Please remove all parts from seat frames and ottoman before assembly\*\*\*

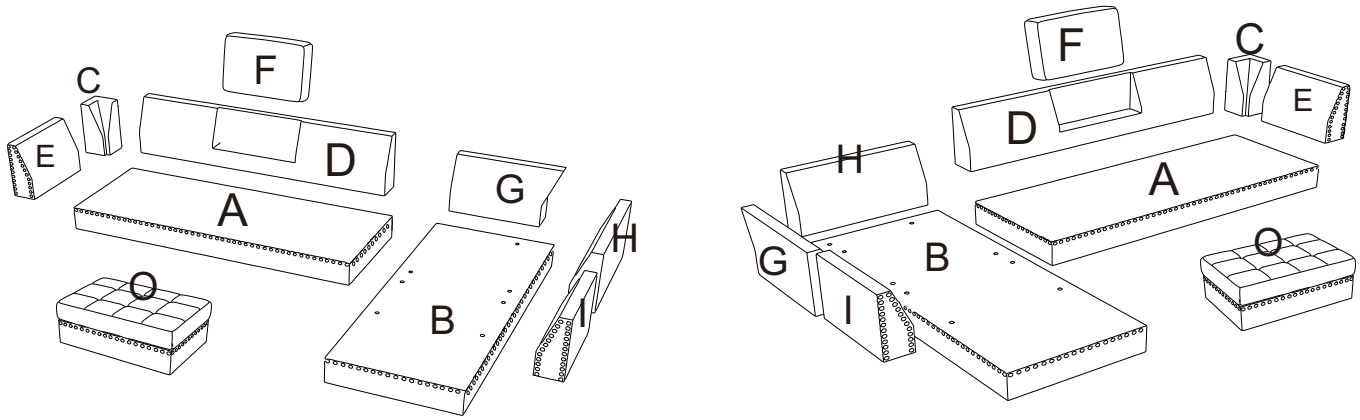

# ONE - ARM SOFA ASSEMBLY INSTRUCTION - BOX 1

STEP 1 - INSERT THREADED RODS INTO SEAT BACKS & ARM

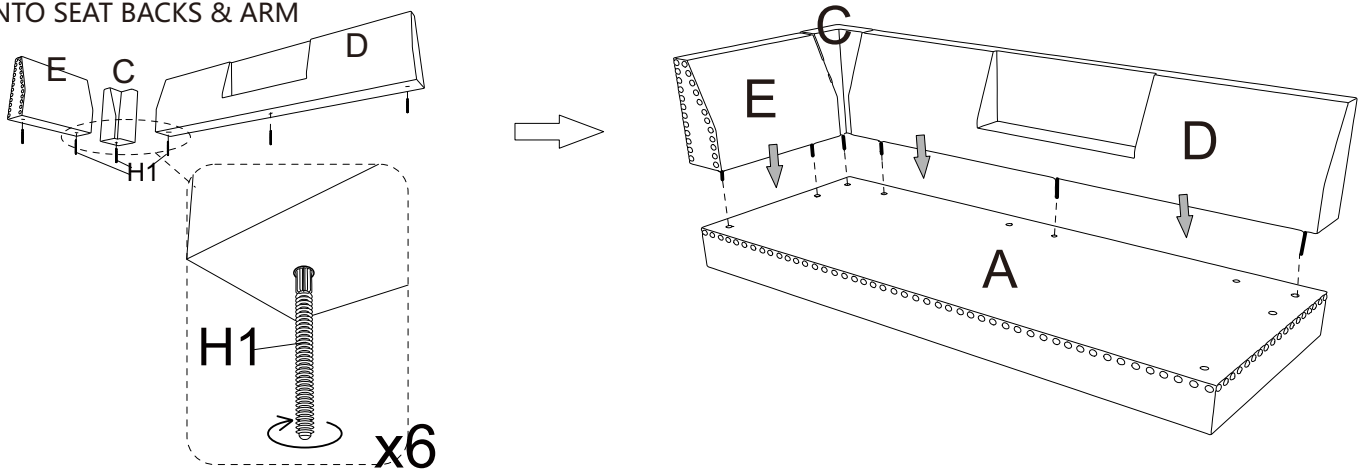

STEP 2 - MOUNT BACKS & ARM INTO THE SEAT FRAME

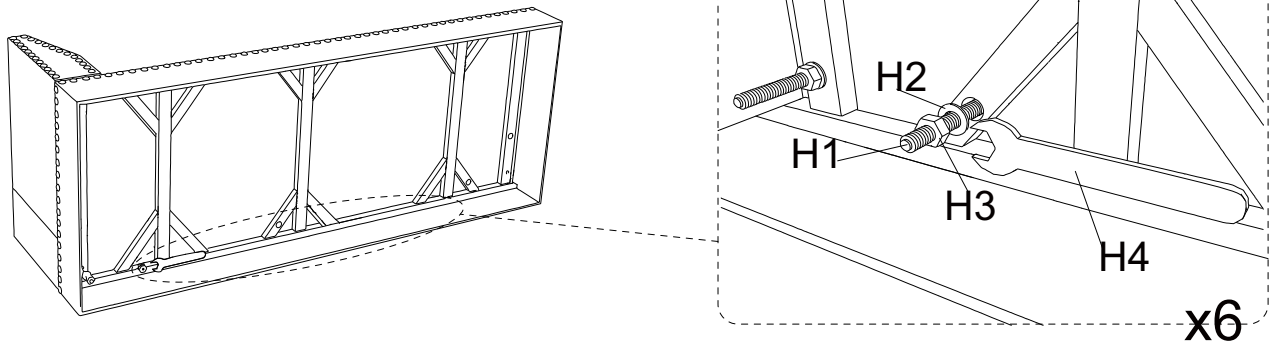

STEP 3 - PUT BACK THE FABRIC COVER AND INSERT LEGS

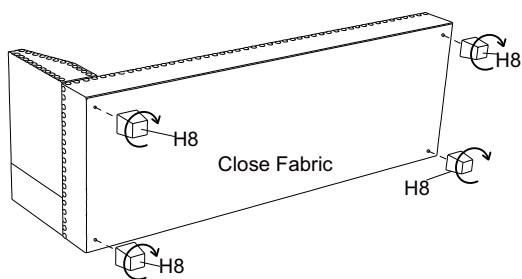

STEP 4

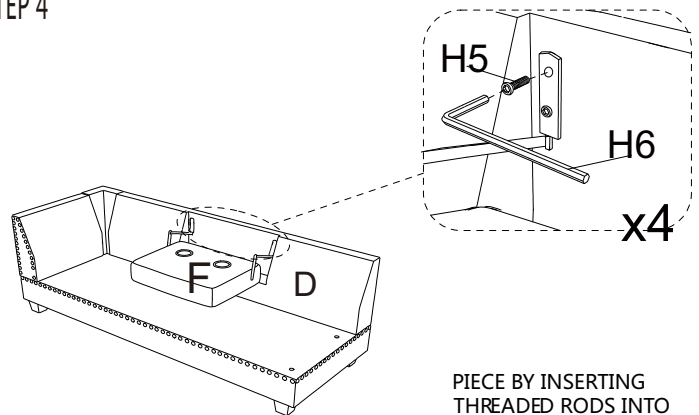

PIECE BY INSERTING THREADED RODS INTO THE BACK GROOVE WITH HEXAGON WRENCH AT TWO SIDES.

# CHAISE ASSEMBLY INSTRUCTION - BOX2

STEP 1 - INSERT THREADED RODS INTO SEAT BACKS & ARM

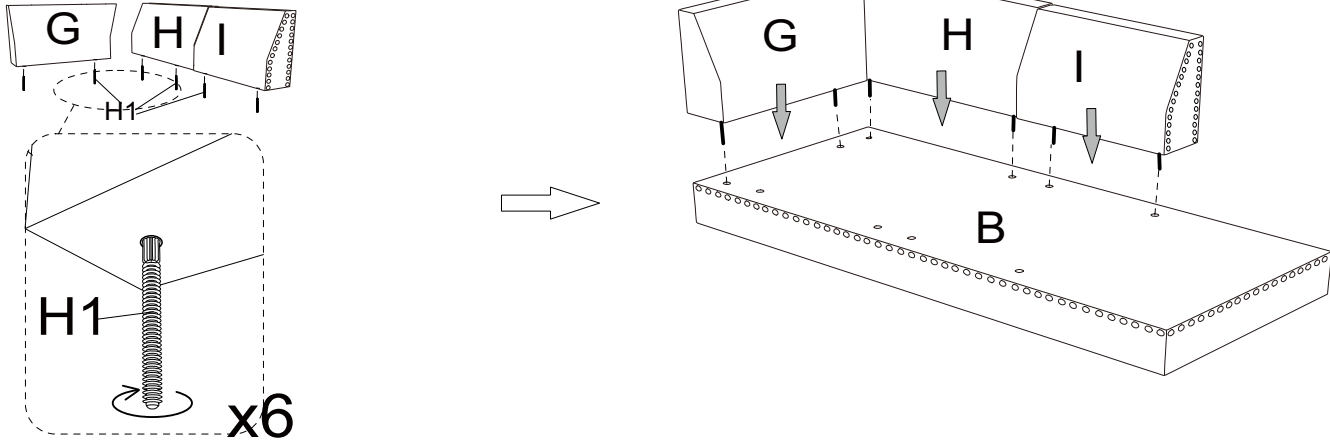

STEP 2 - MOUNT BACKS & ARM INTO THE SEAT FRAME

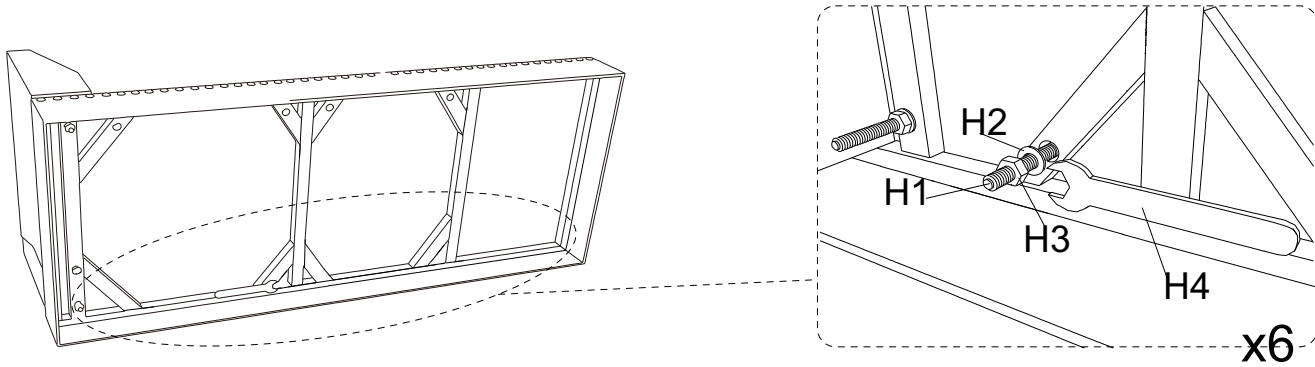

STEP 3 - PUT BACK THE FABRIC COVER AND INSERT LEGS

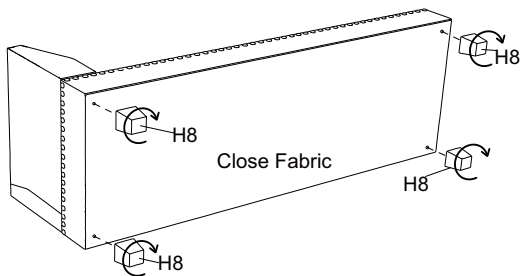

STEP 4 INSTRUCTION BOX-1 AND BOX-2

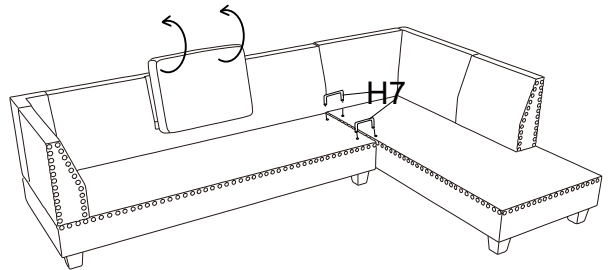

STEP 5

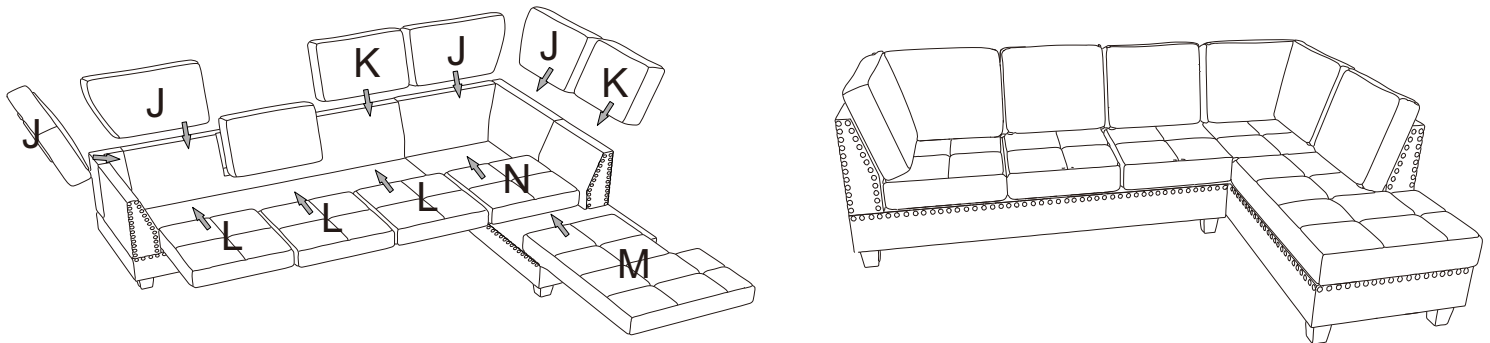

# ONE - ARM SOFA ASSEMBLY INSTRUCTION - BOX 1

## STEP 1 - INSERT THREADED RODS INTO SEAT BACKS & ARM

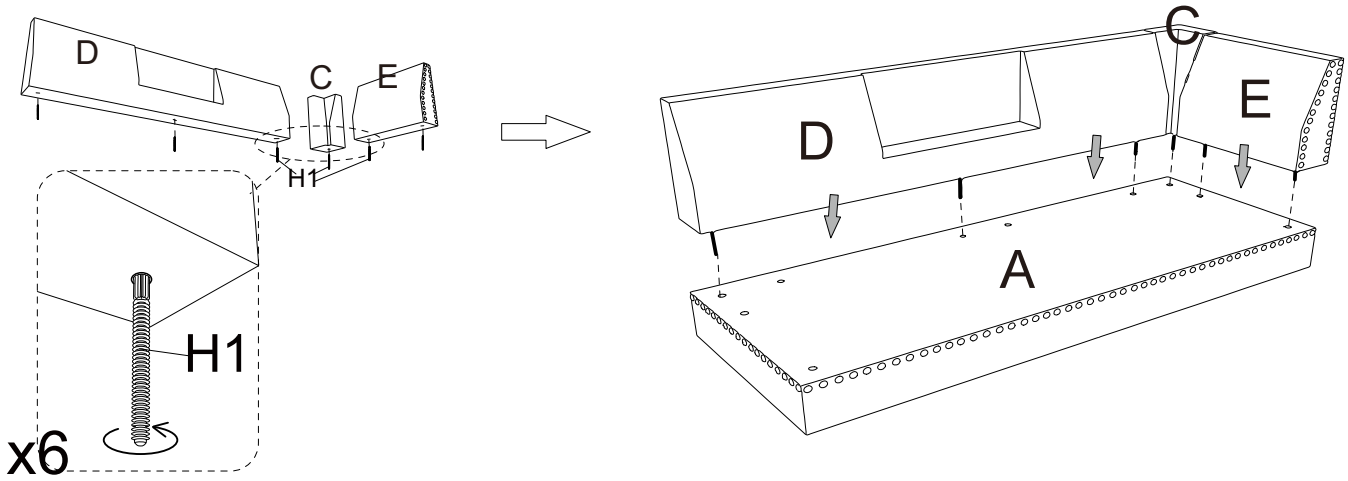

## STEP 2 - MOUNT BACKS & ARM INTO THE SEAT FRAME

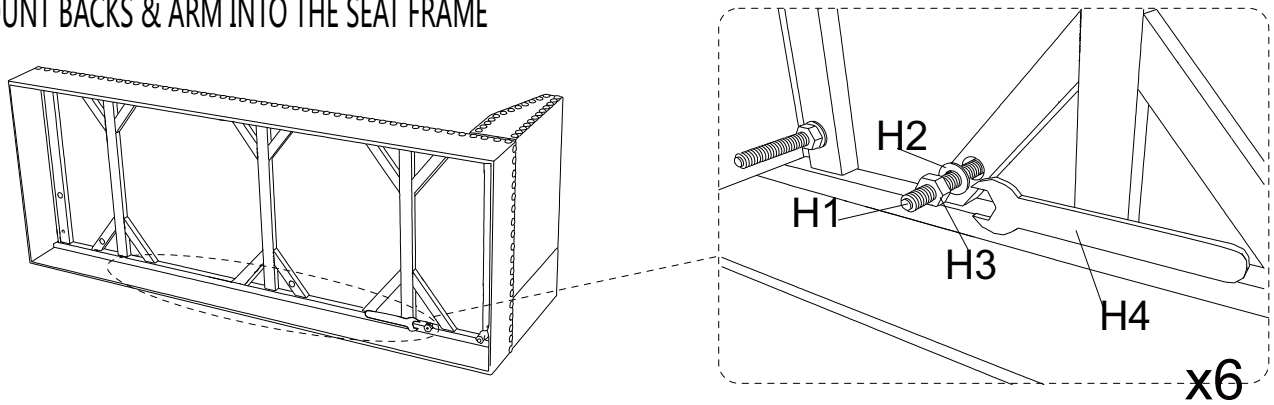

## STEP 3 - PUT BACK THE FABRIC COVER AND INSERT LEGS

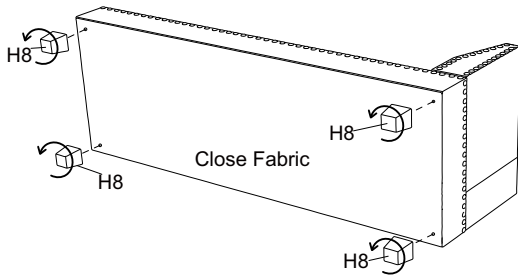

## STEP 4

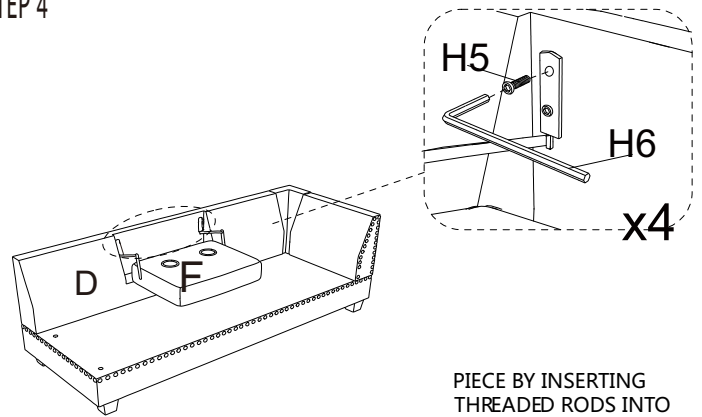

PIECE BY INSERTING  
THREADED RODS INTO  
THE BACK GROOVE WITH  
HEXAGON WRENCH AT  
TWO SIDES.

# CHAISE ASSEMBLY INSTRUCTION - BOX 2

## STEP 1 - INSERT THREADED RODS INTO SEAT BACKS & ARM

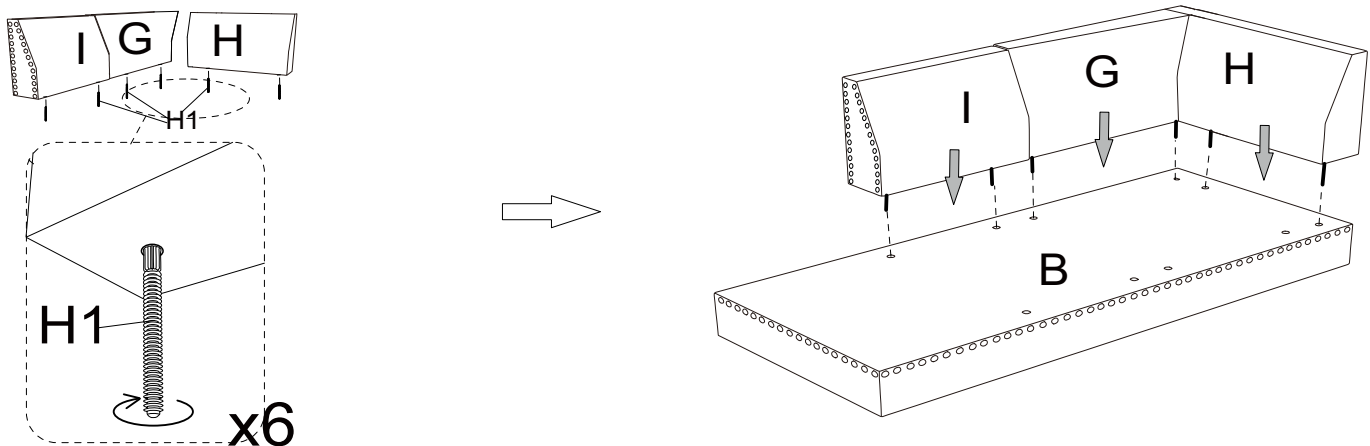

STEP 2 - MOUNT BACKS & ARM INTO THE SEAT FRAME

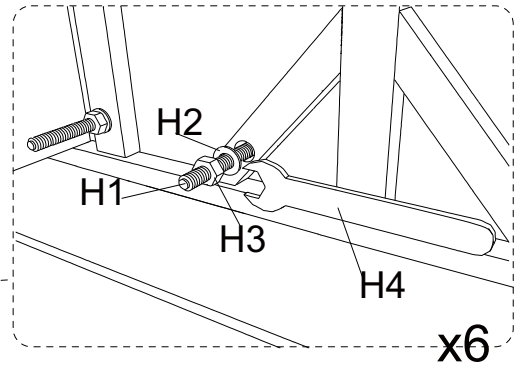
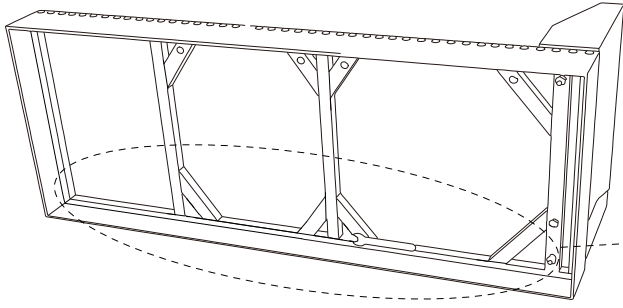

STEP 3 - PUT BACK THE FABRIC COVER AND INSERT LEGS

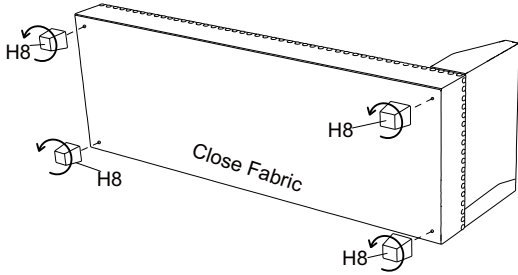

STEP 4 INSTRUCTION BOX-1 AND BOX-2

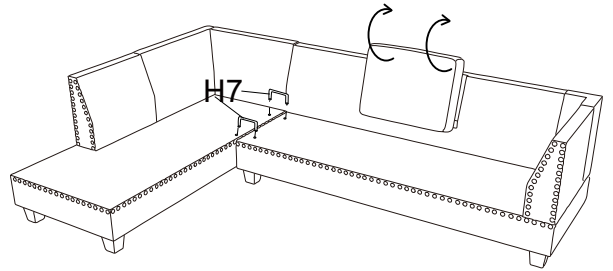

STEP 5

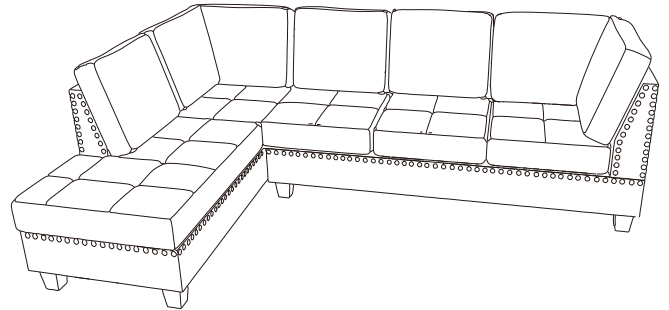
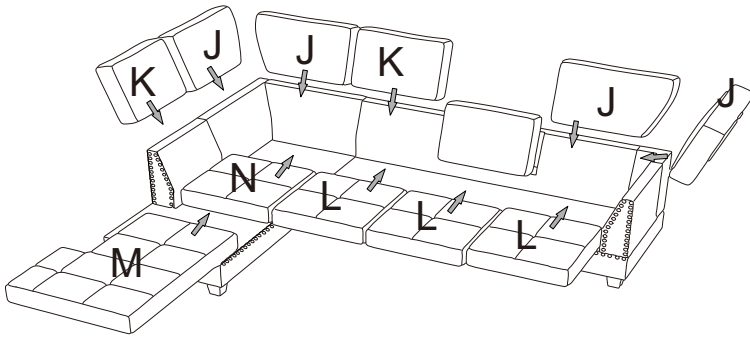

CHAISE ASSEMBLY INSTRUCTION - BOX3

STEP 1

